

CAMBRIDGE

SUPER Minds

Workbook Starter

Herbert Puchta

Günter Gerngross

Peter Lewis-Jones

books.ru

Herbert Puchta

Günter Gerngross

Peter Lewis-Jones

SUPER MINDS

Workbook Starter

●	Hello	2	6	On the farm	58
1	My classroom	8	7	I'm hungry!	68
2	My family	18	8	All aboard!	78
3	My face	28	9	Party clothes	88
4	Toys	38	●	Cut-outs	99
5	My house	48			



CAMBRIDGE
UNIVERSITY PRESS

Hello

1 Match and say the names.

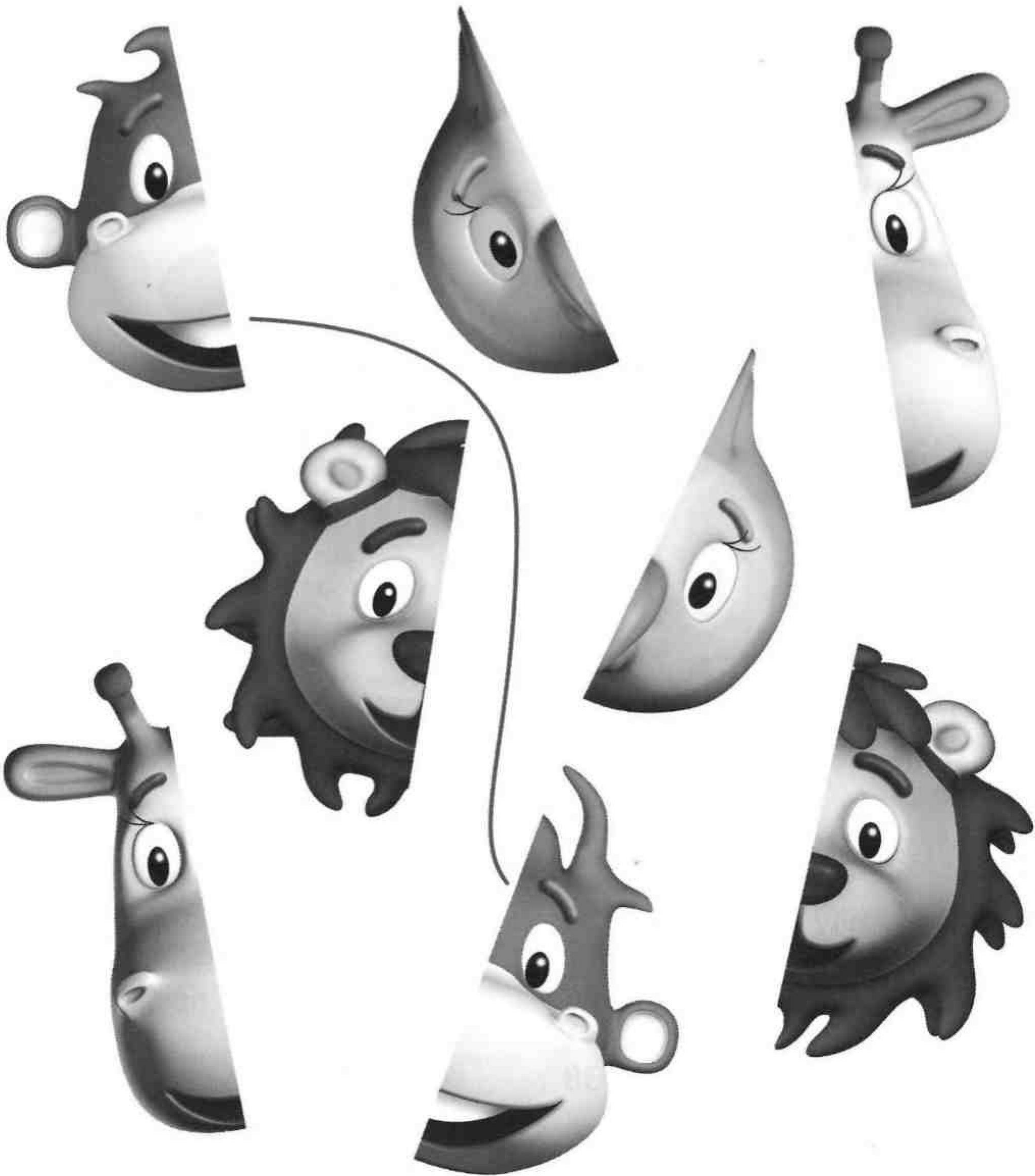

1 Trace and match.

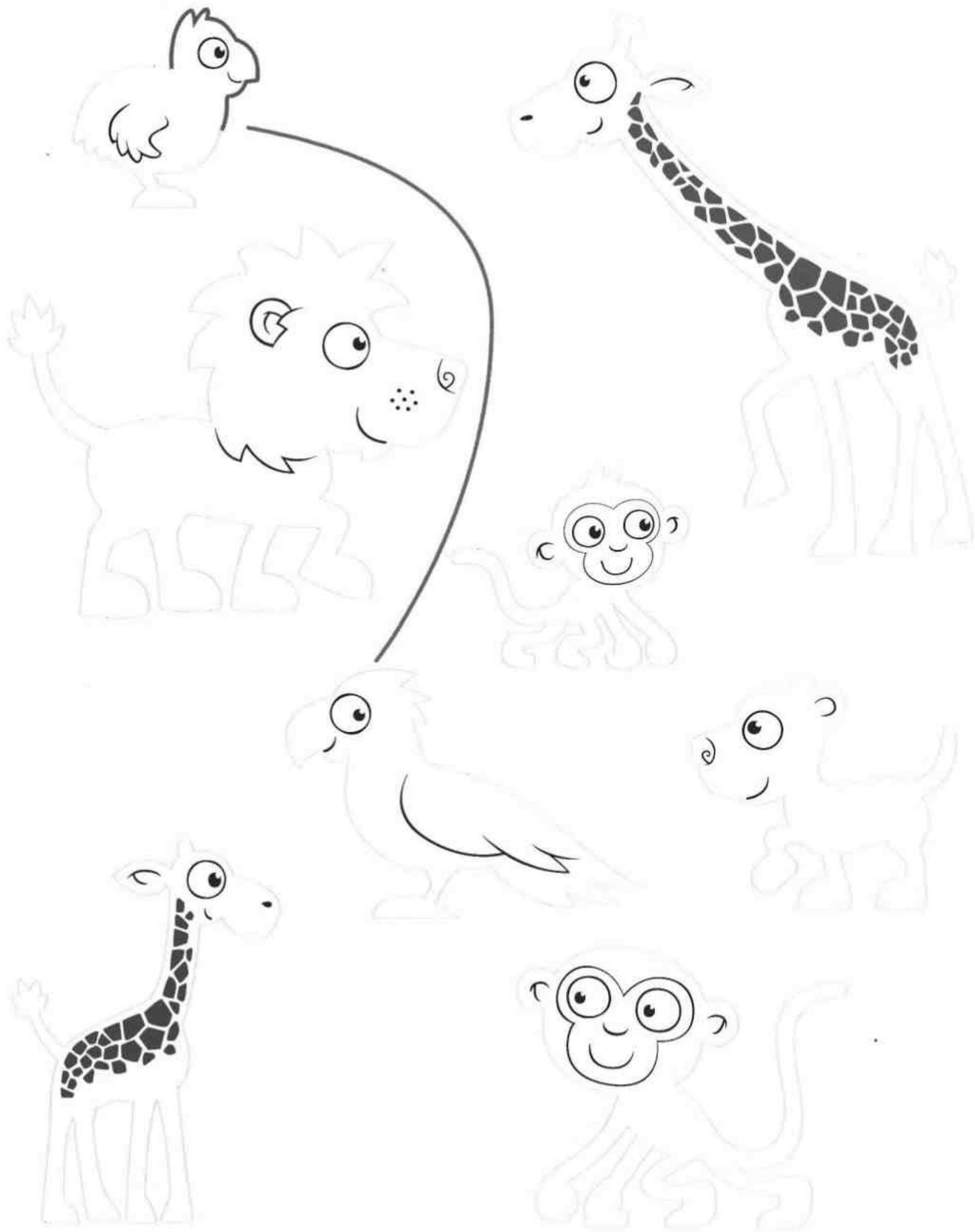

Listen and trace.

1



2

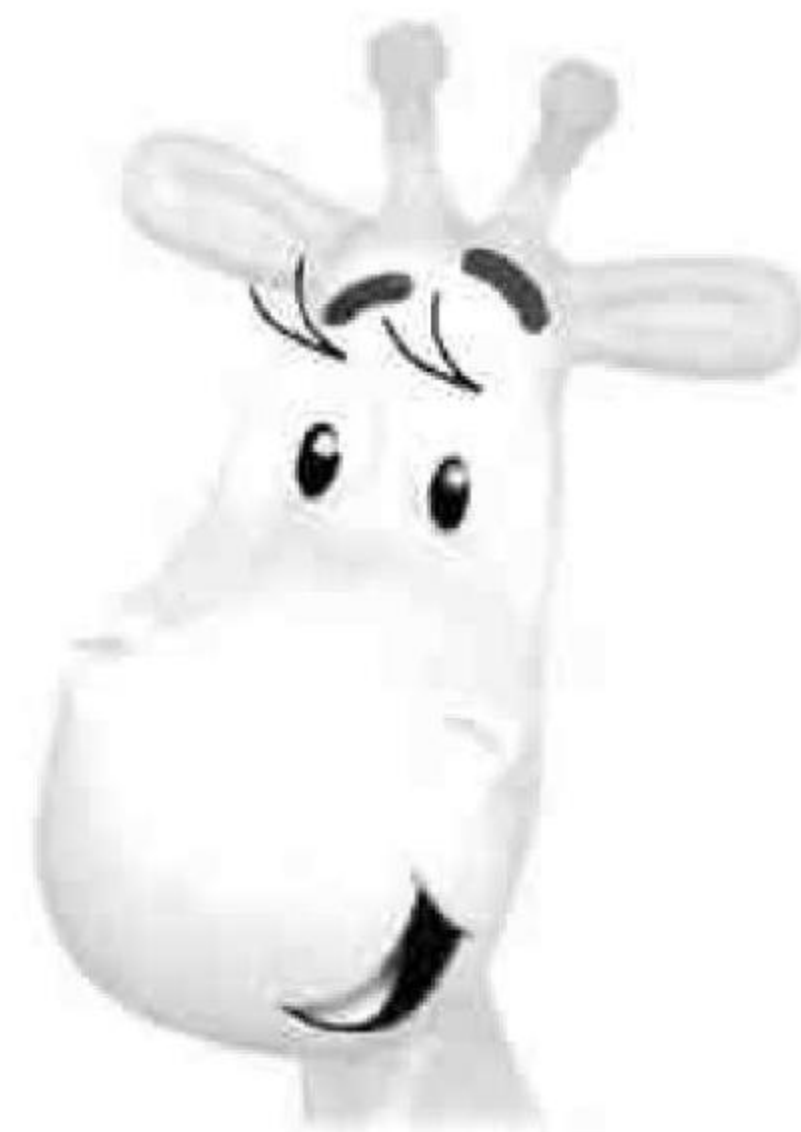

3

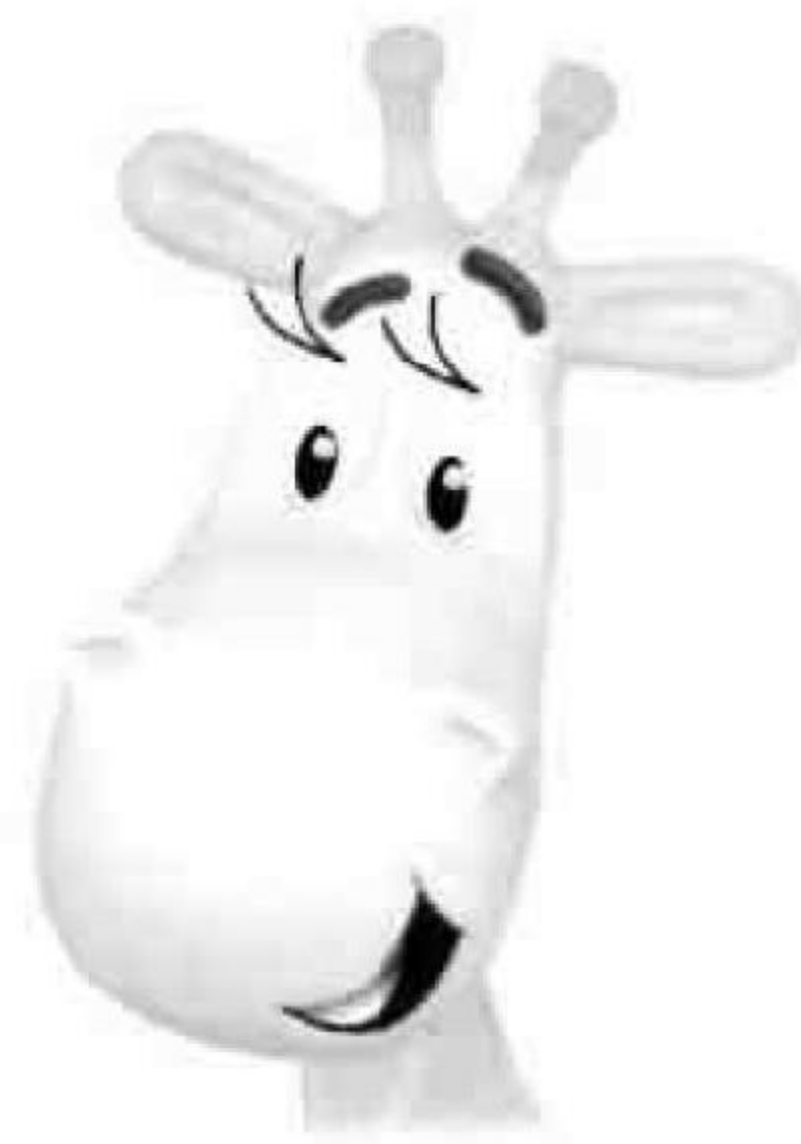

4



Listen and colour.

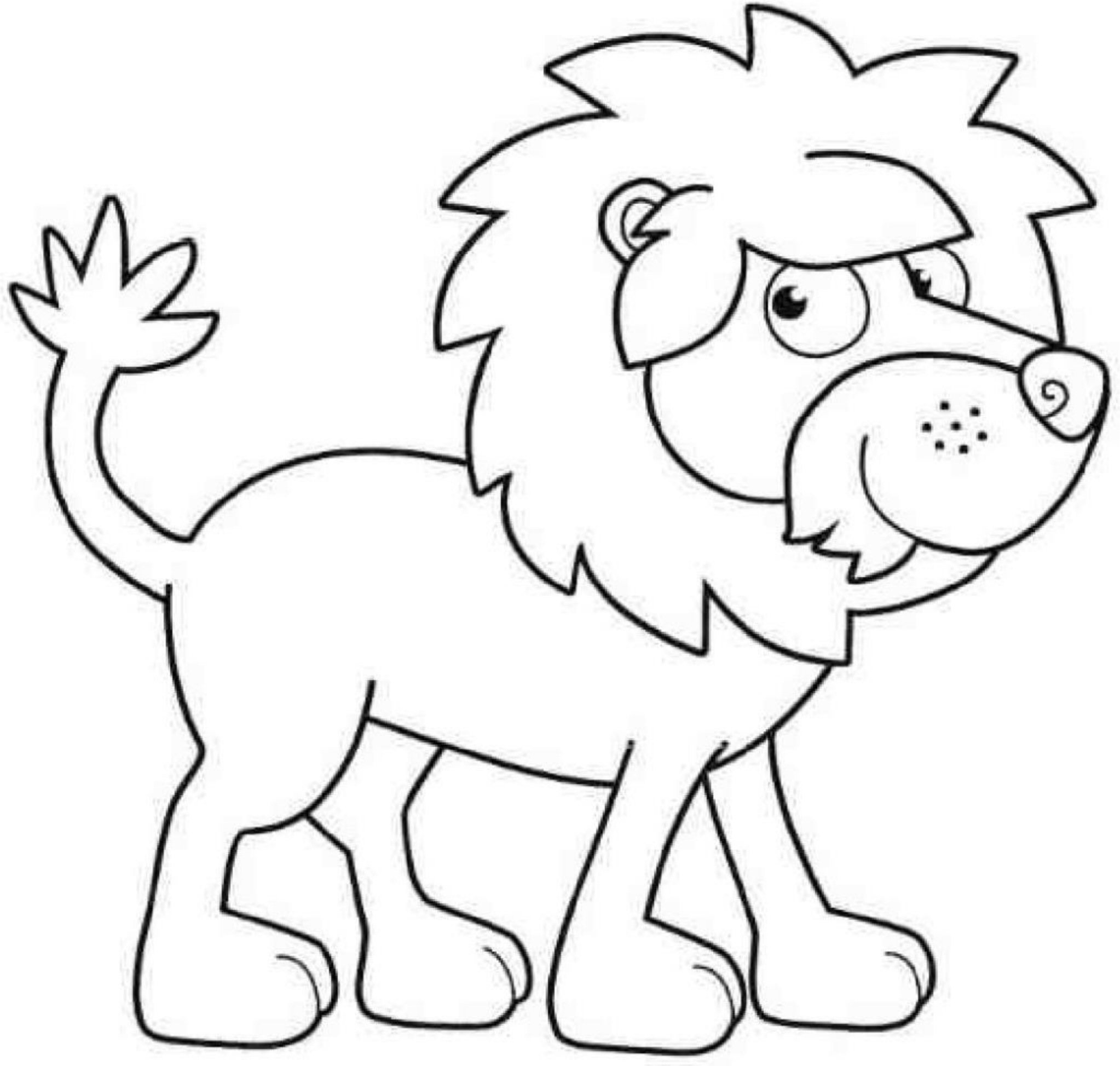
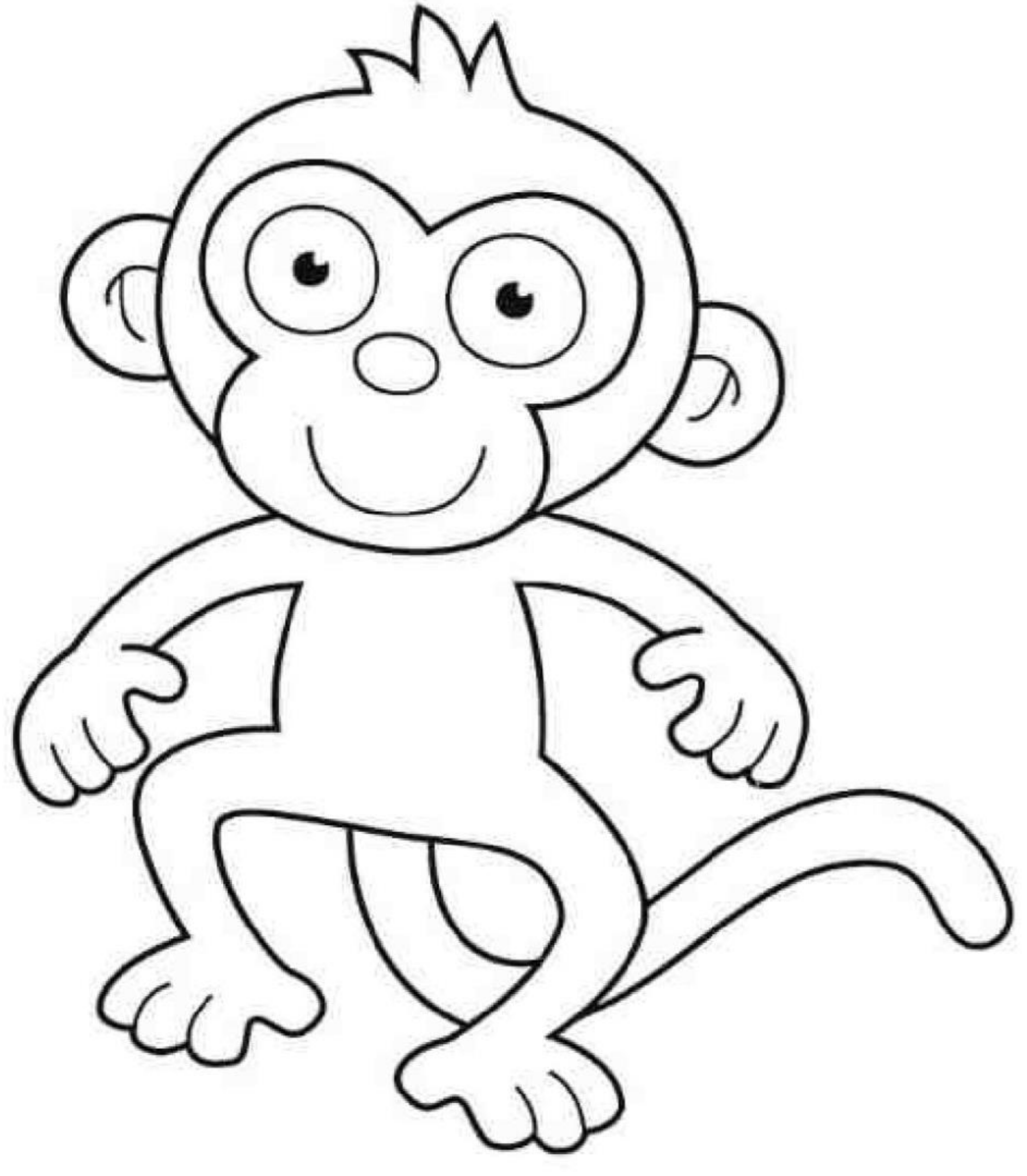
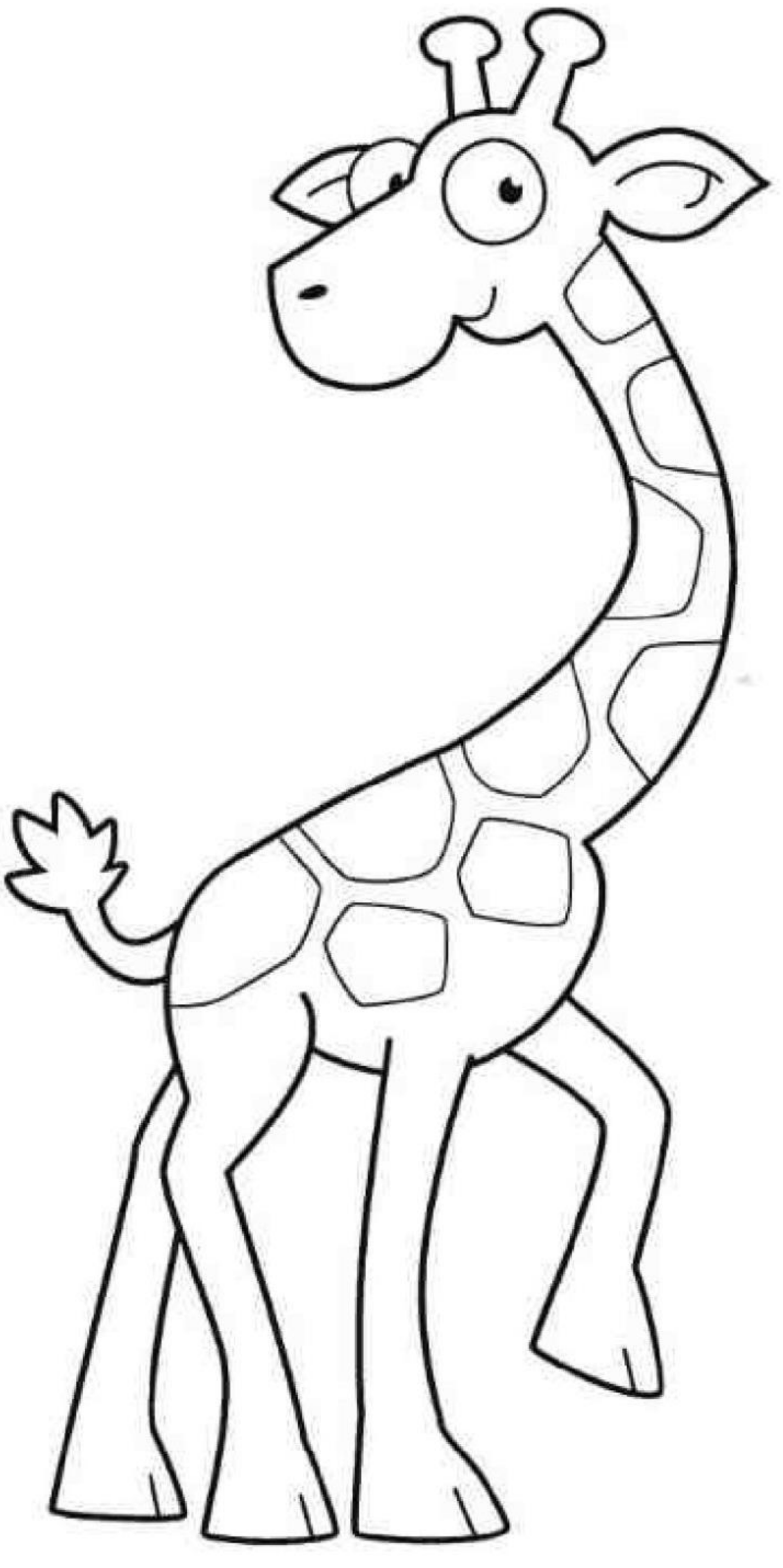

1 Think! Look and colour.

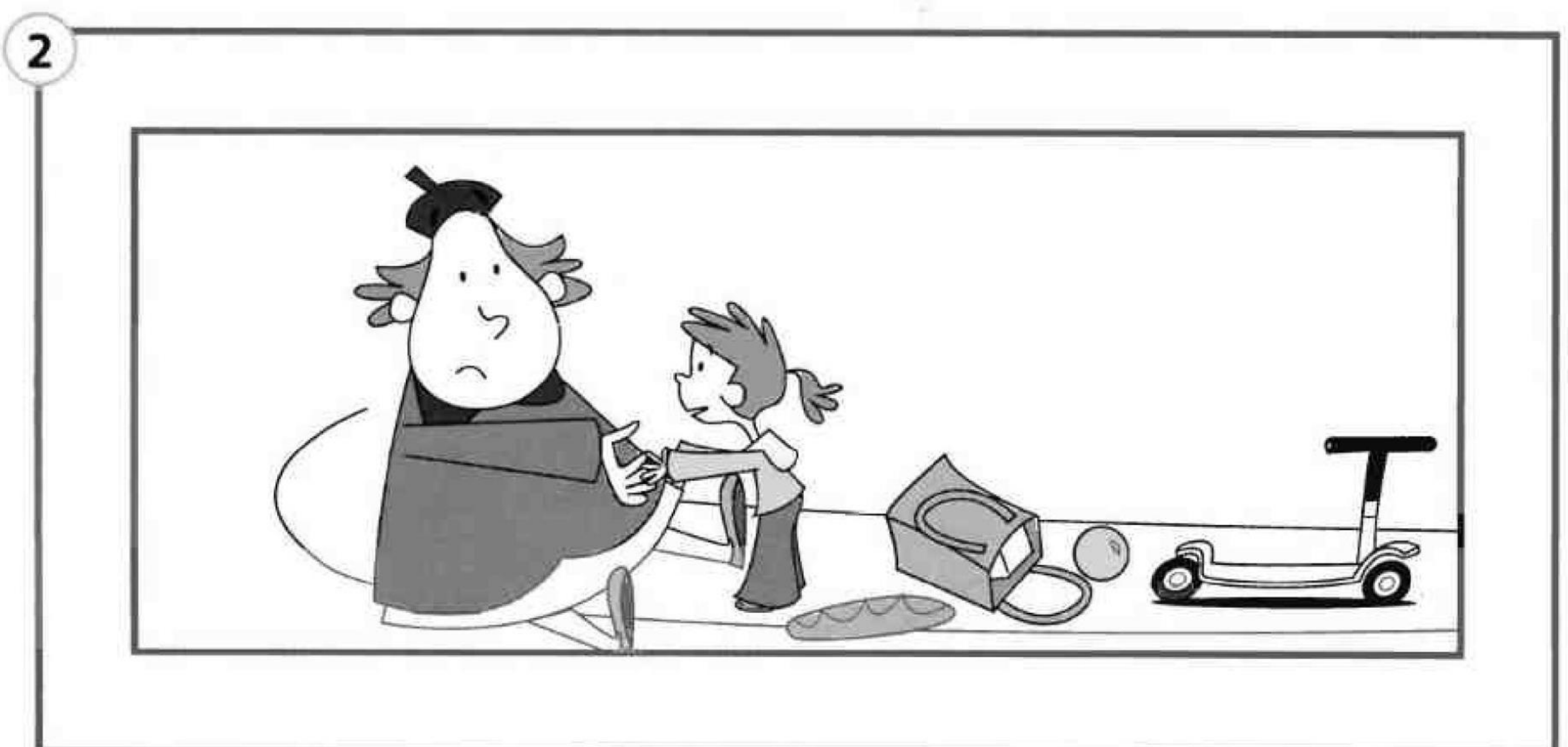
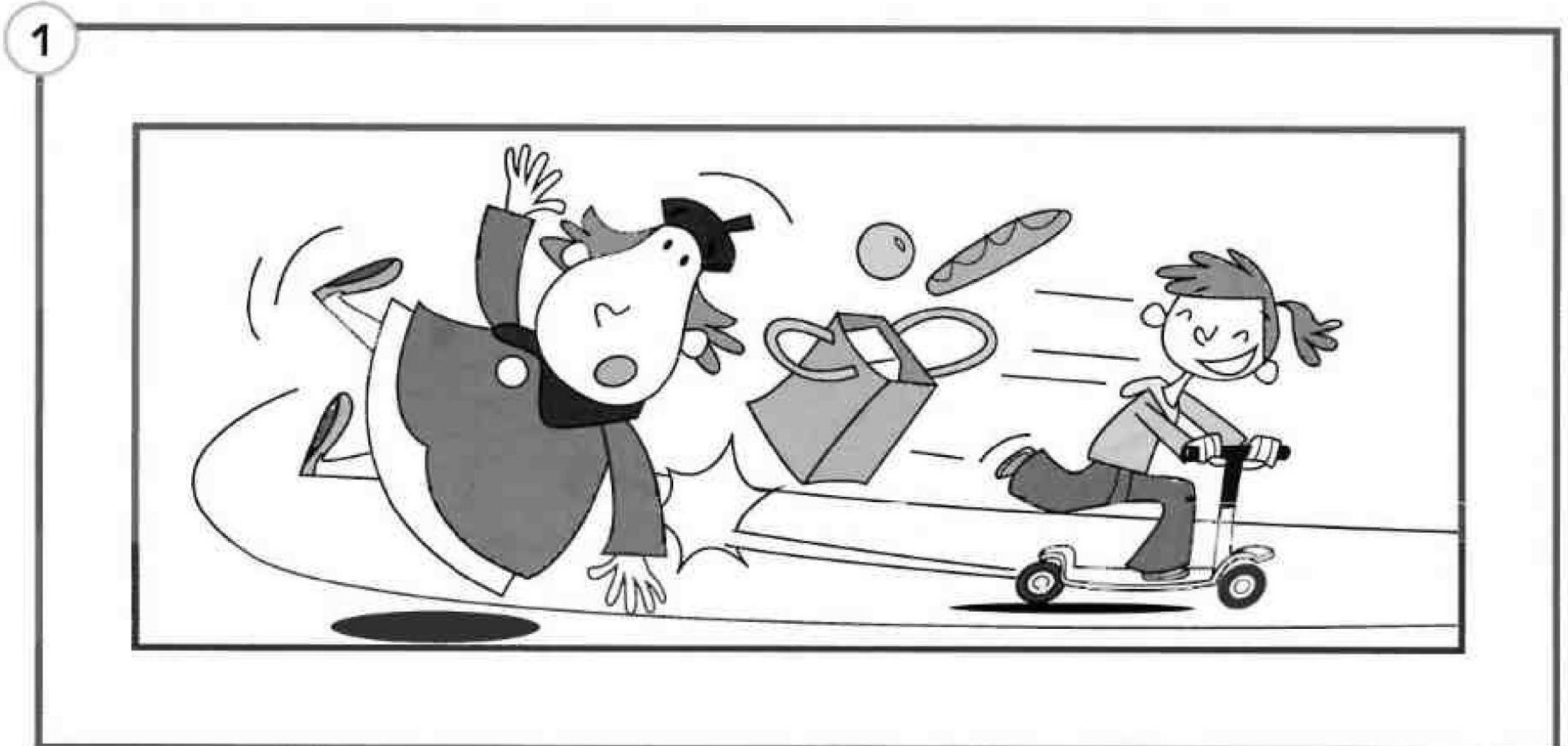
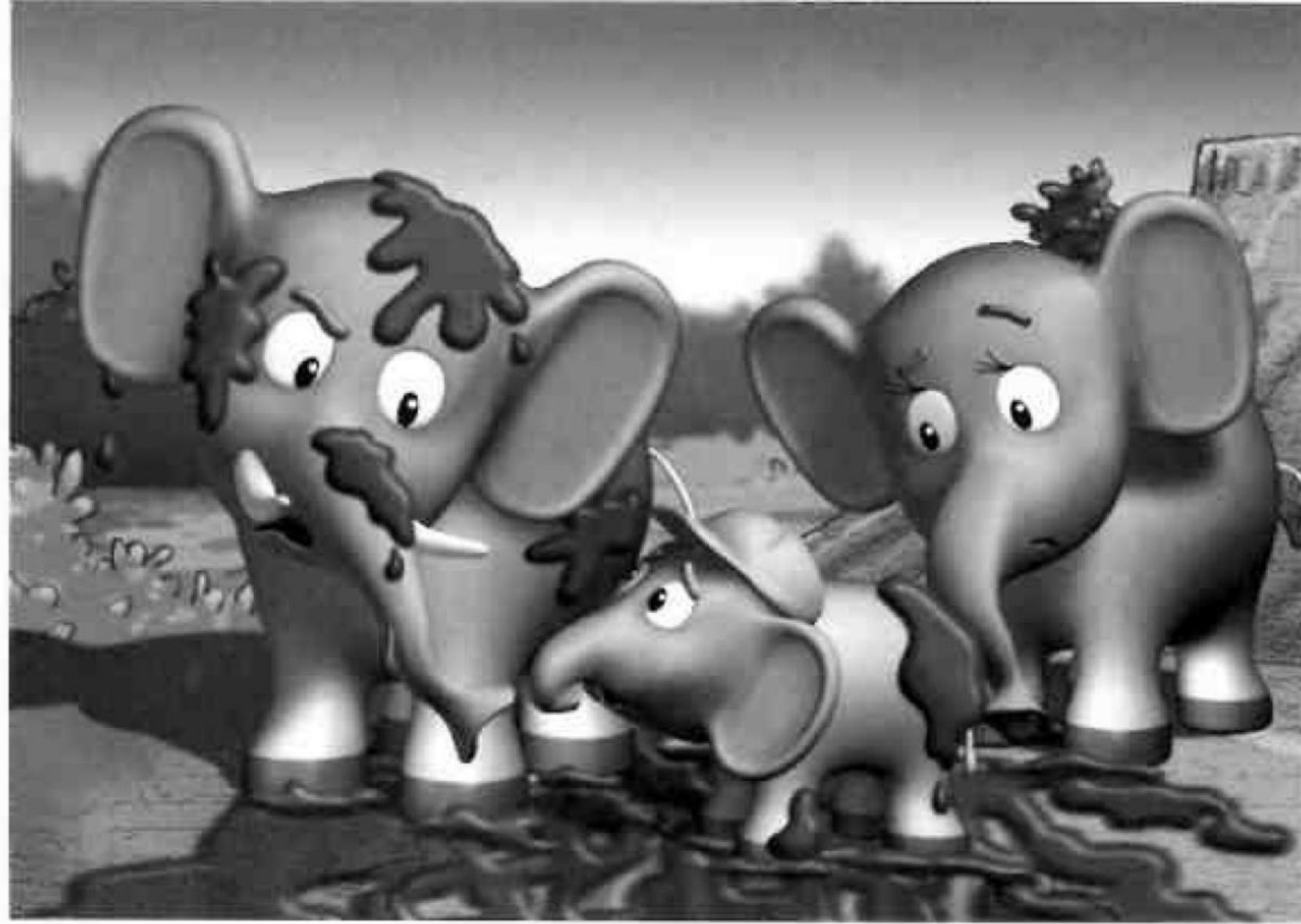

1 Colour. Say the words.

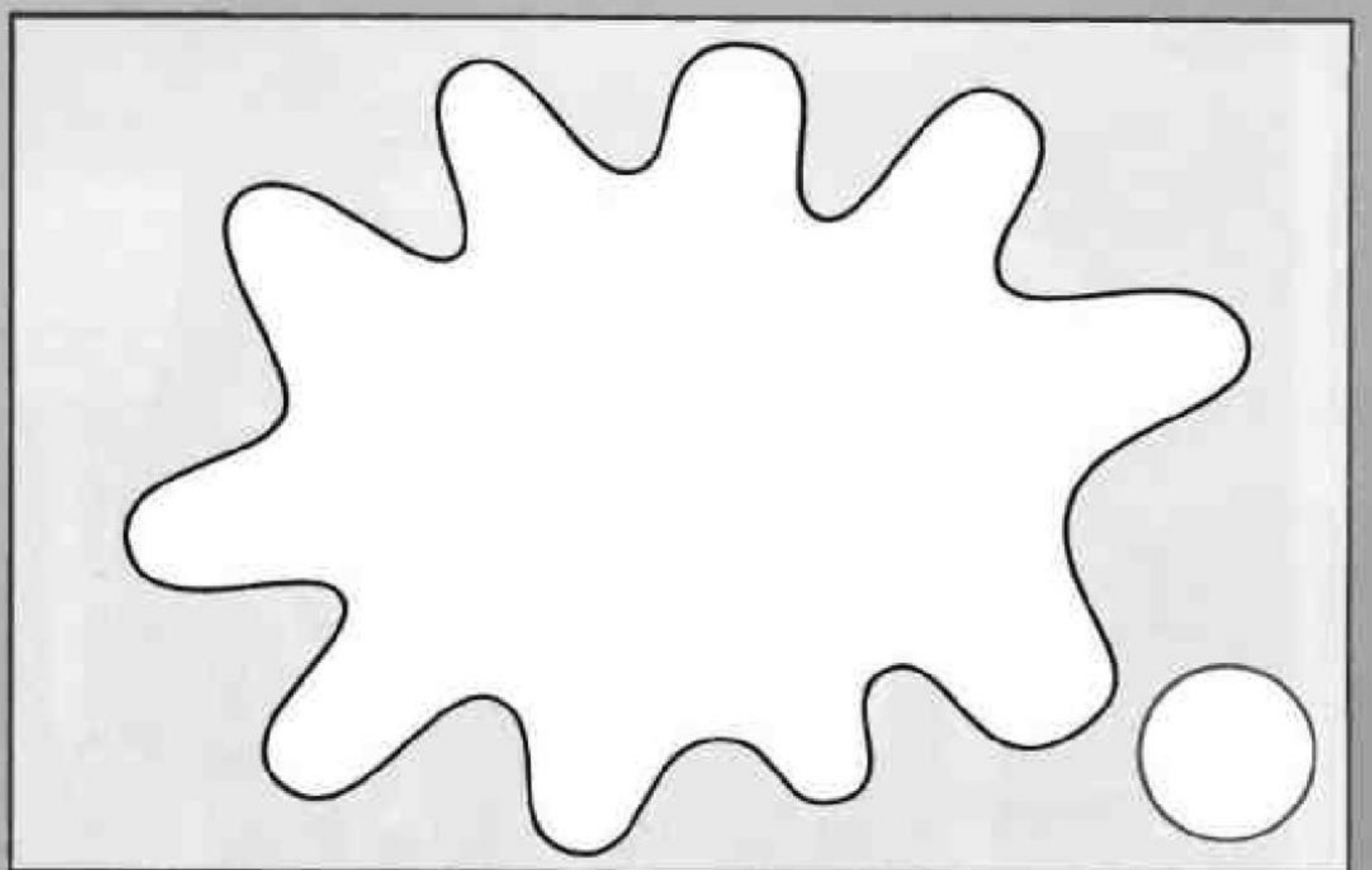
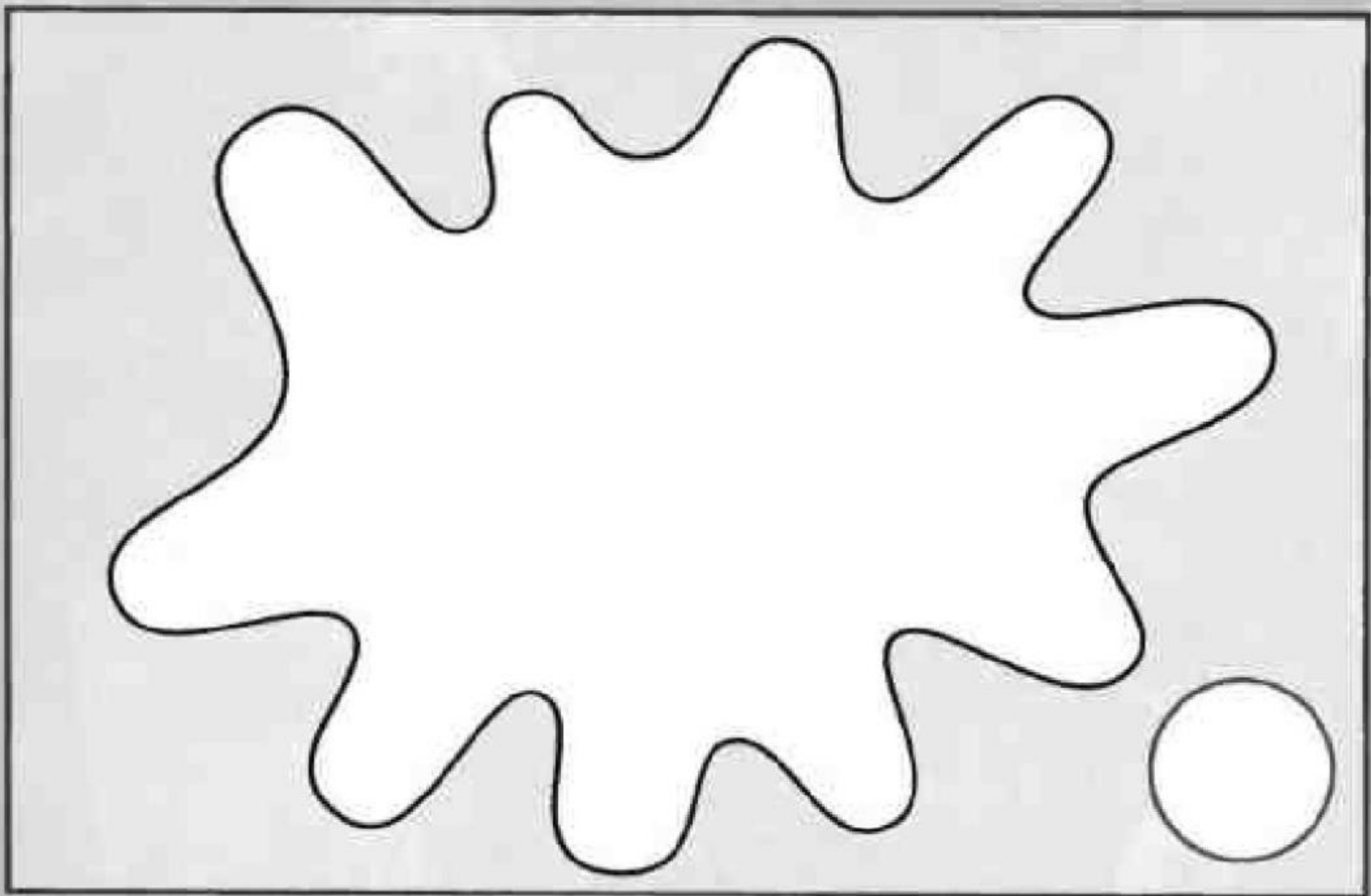
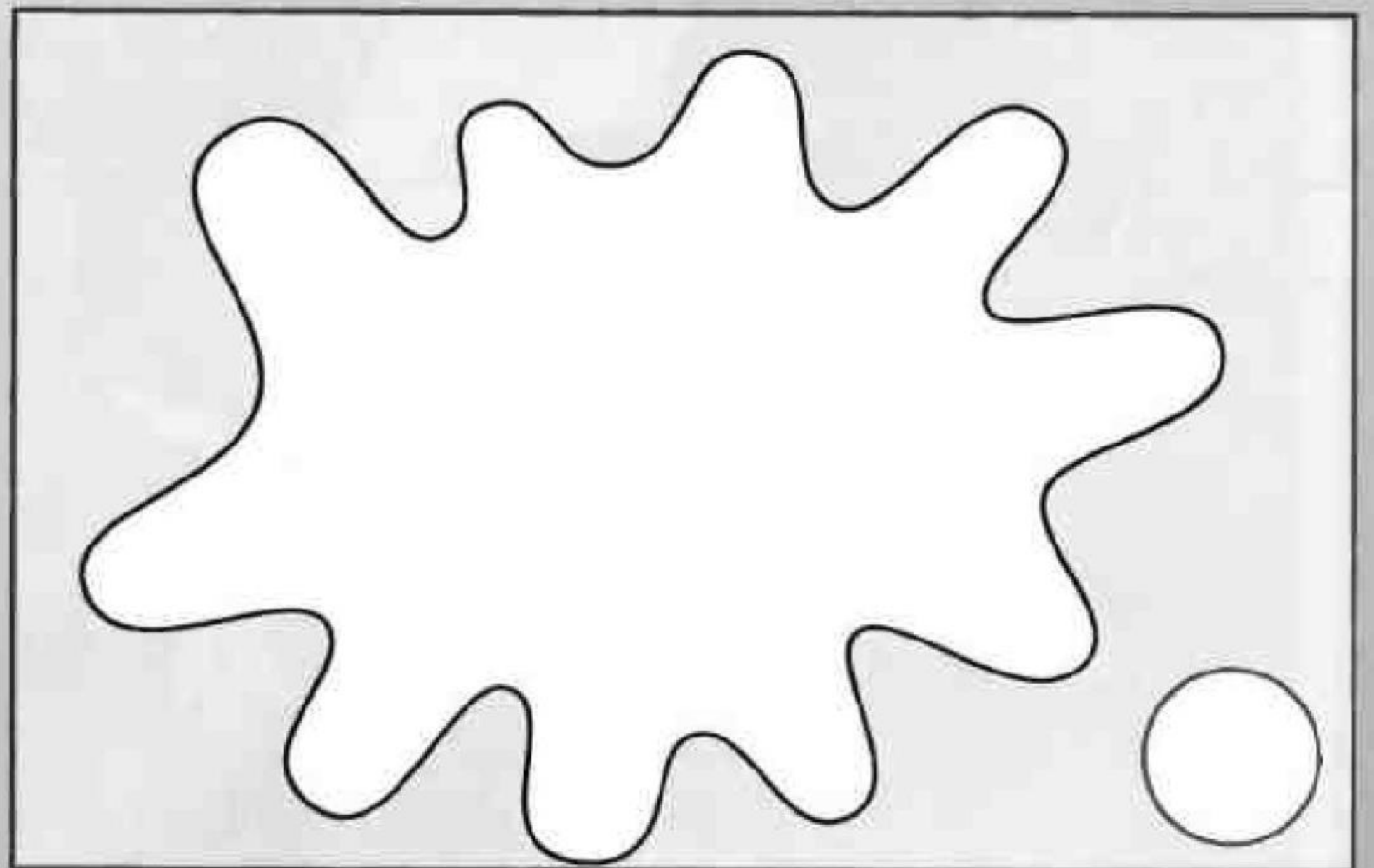
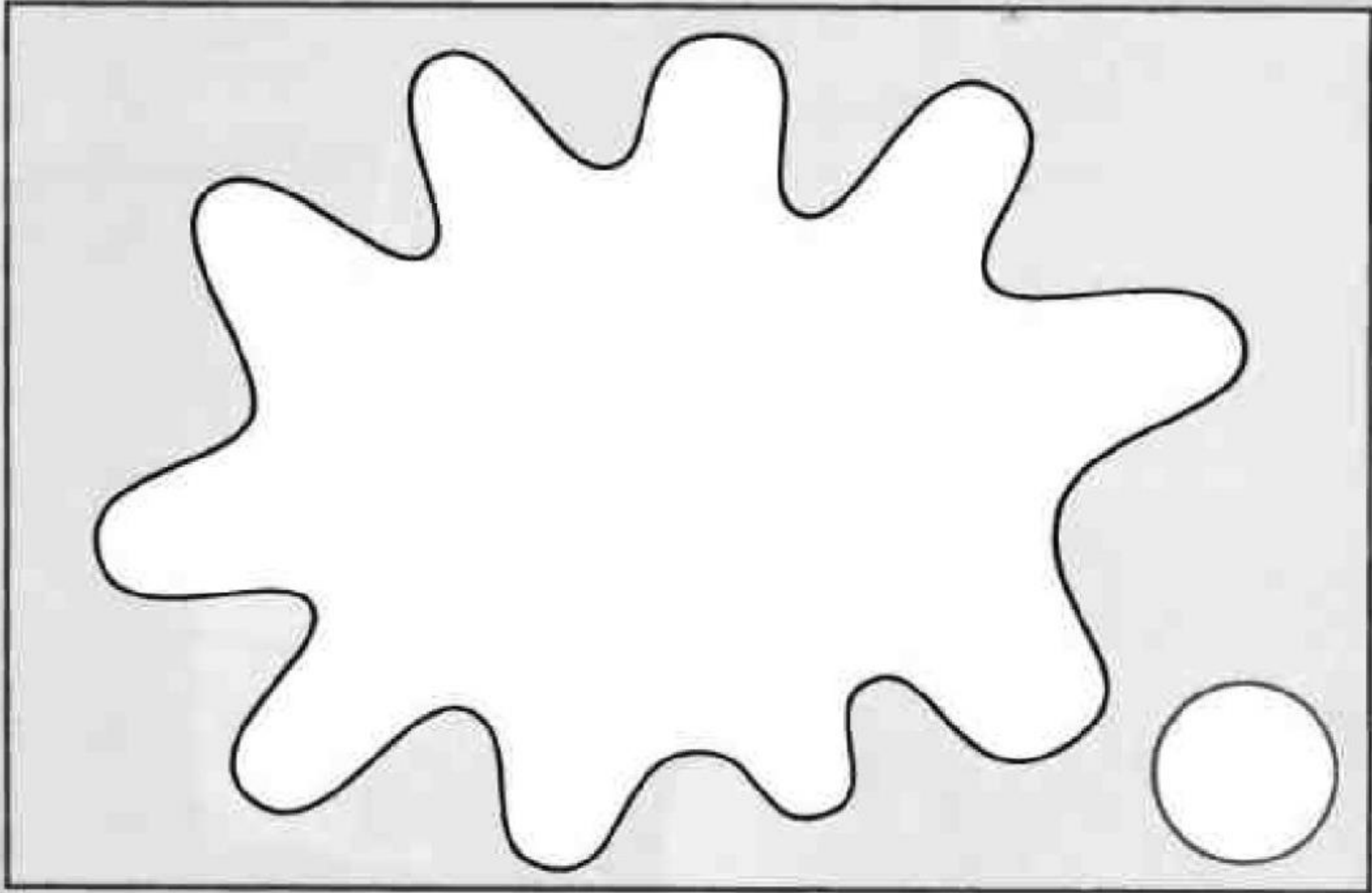
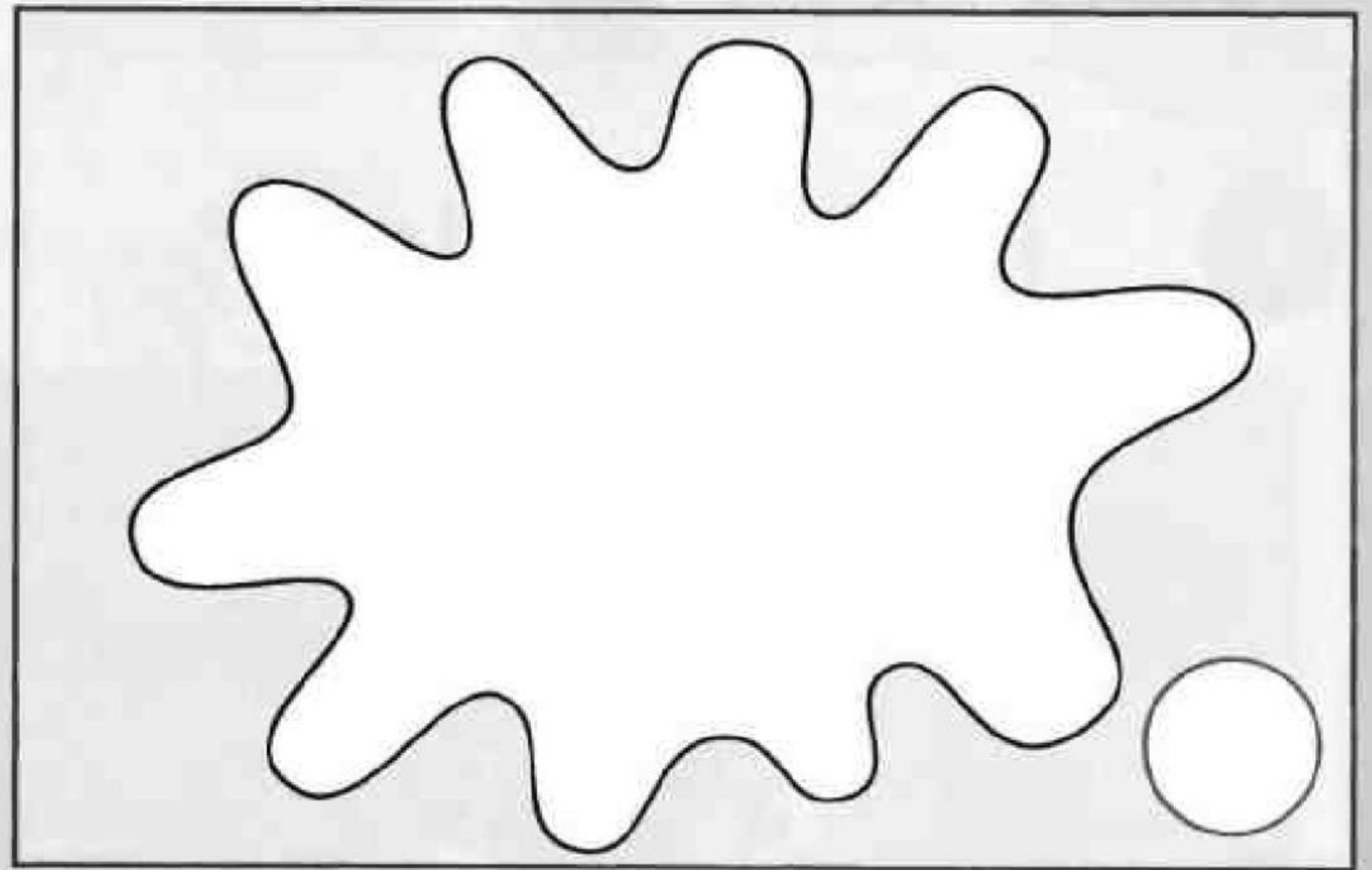
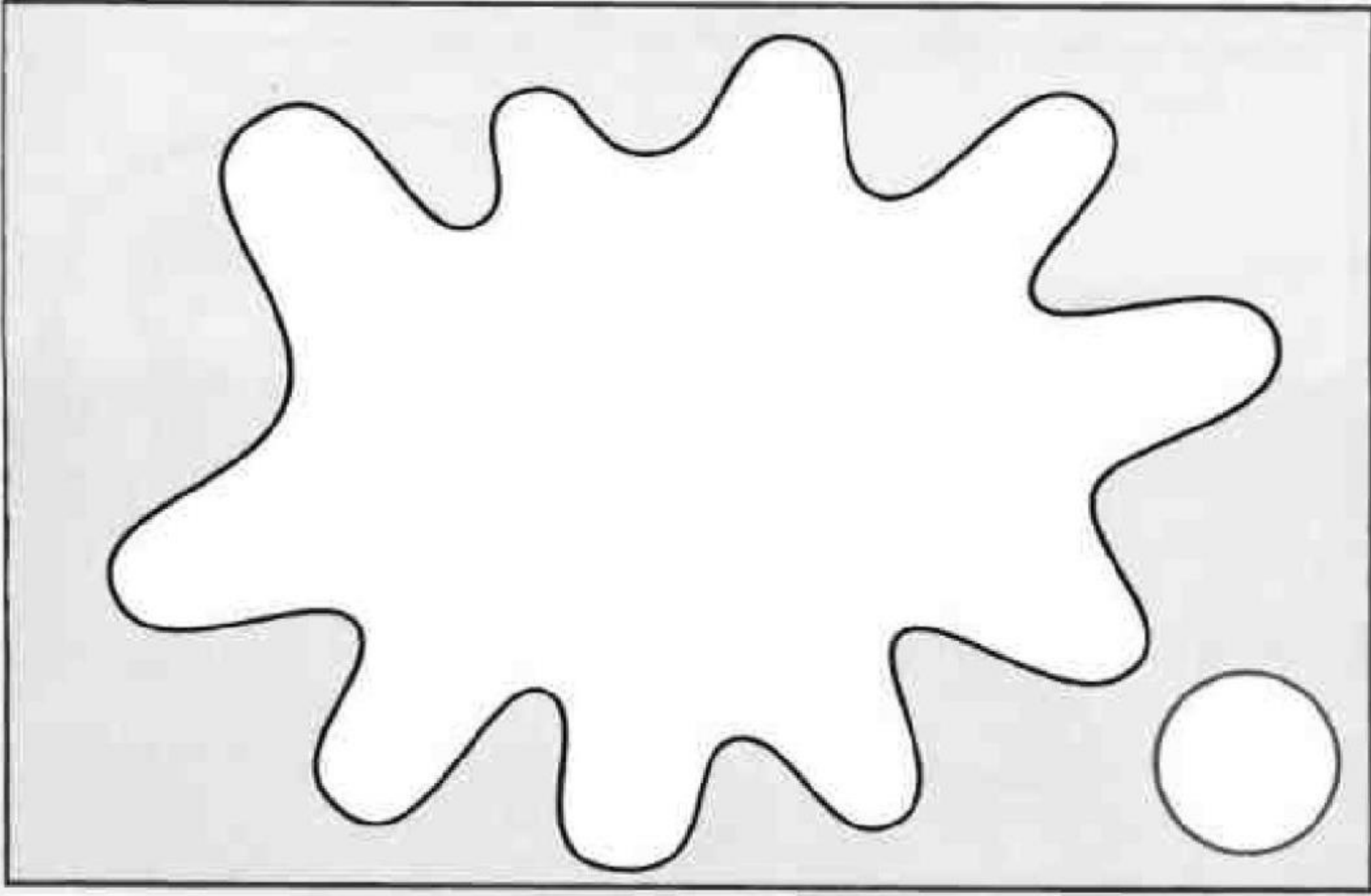

2 Draw faces. 😊 😐 😞

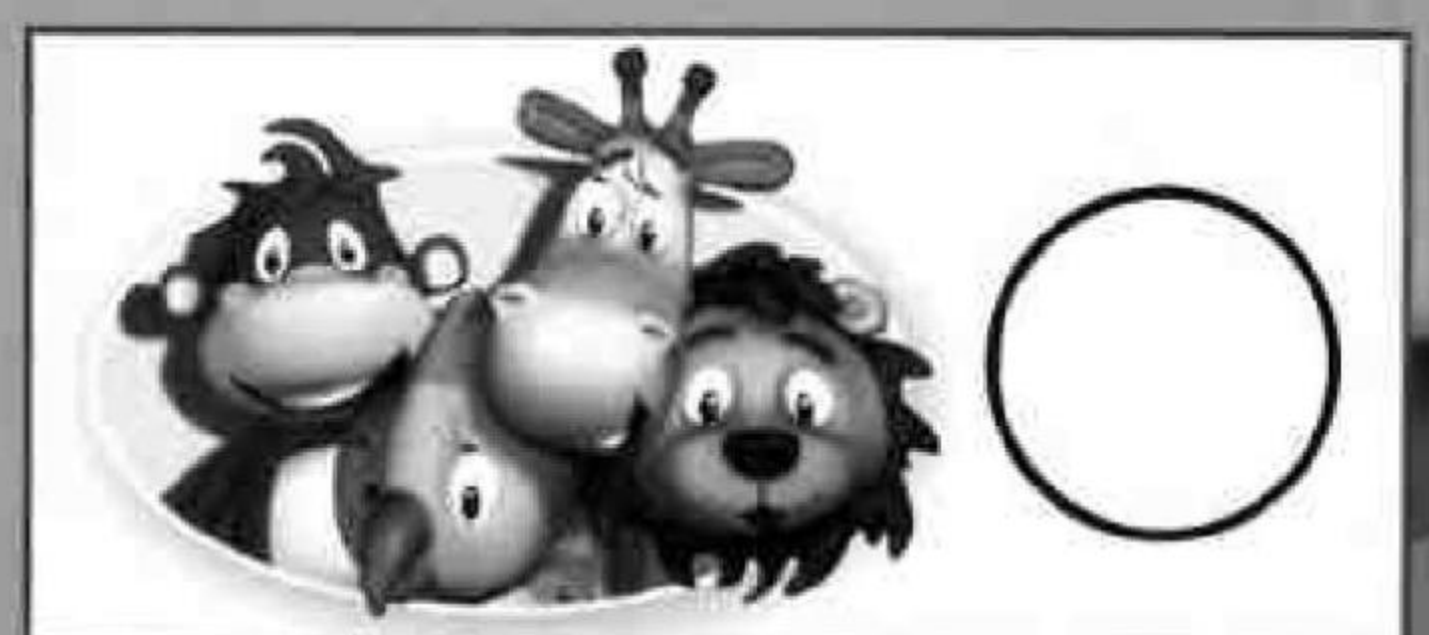
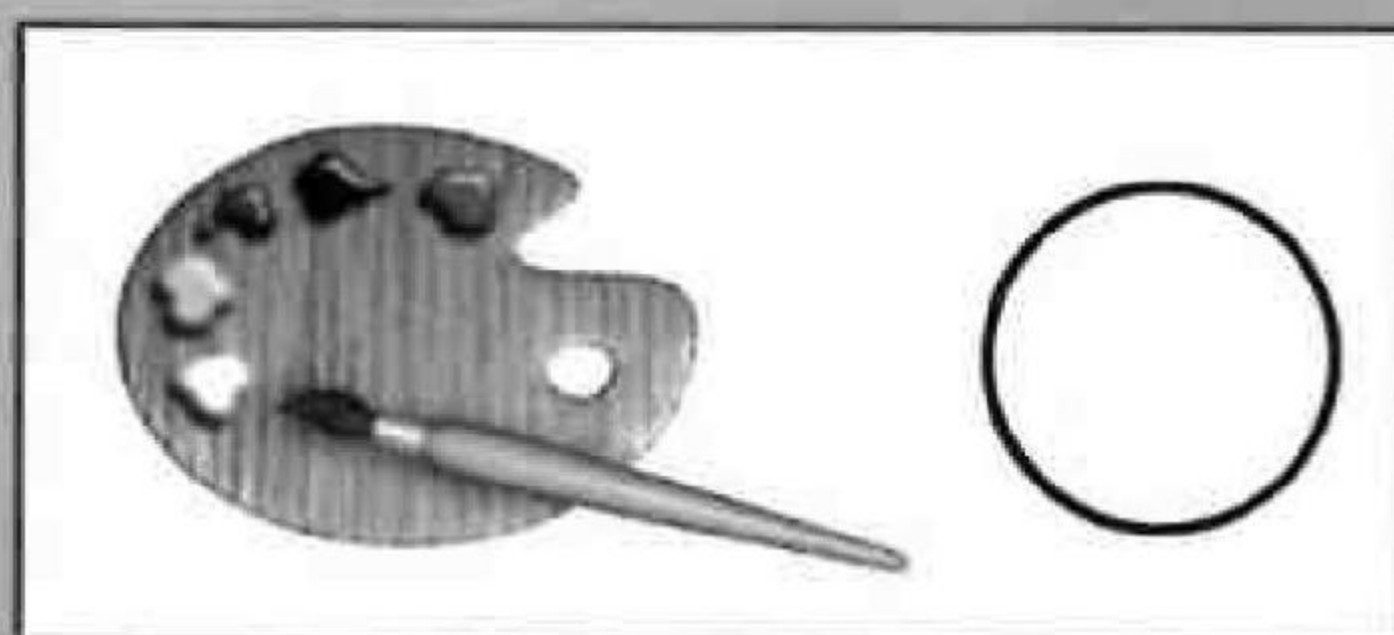
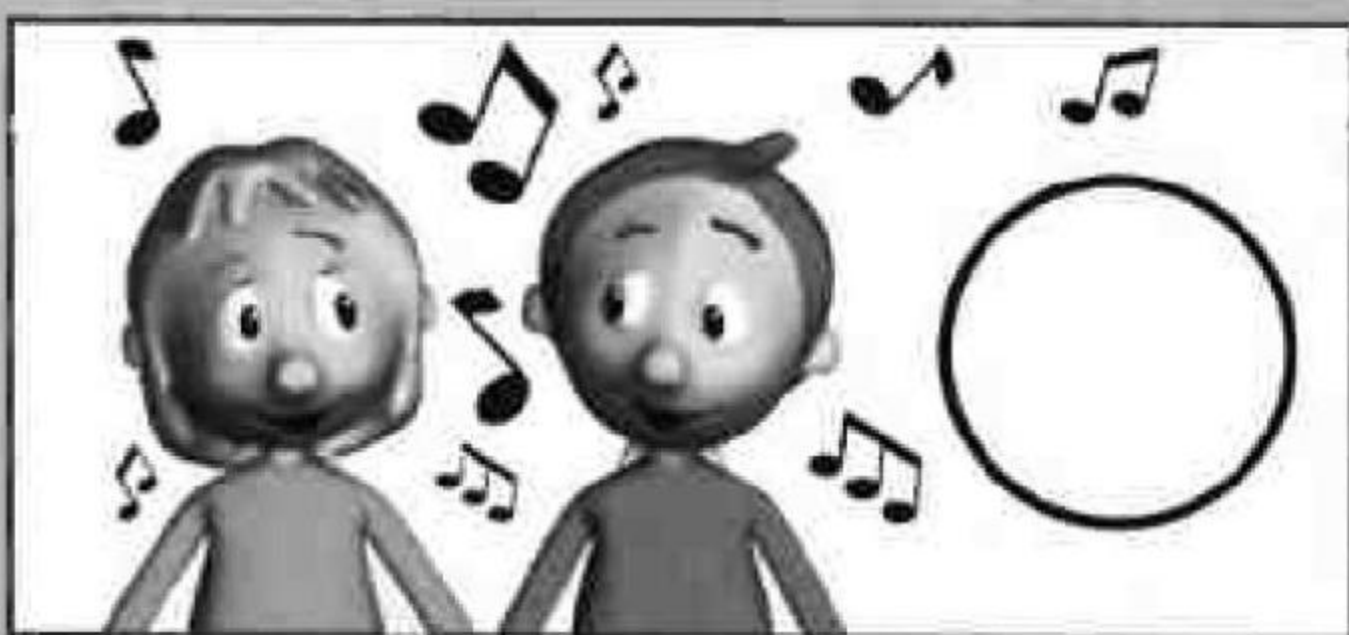

1

My classroom

1

Find and colour.

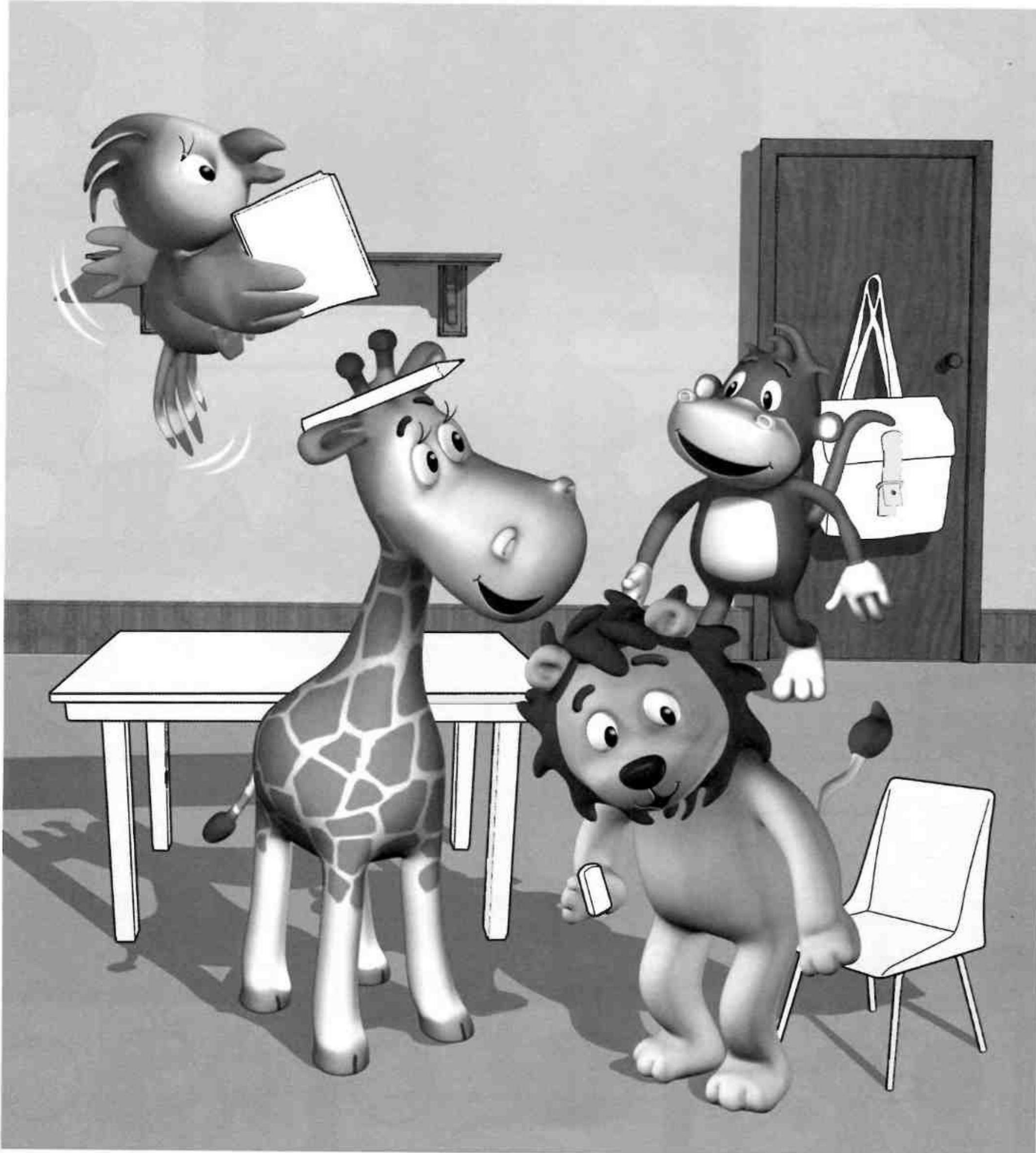

8

pencil, chair, bag, rubber, book, desk

Listen and circle.

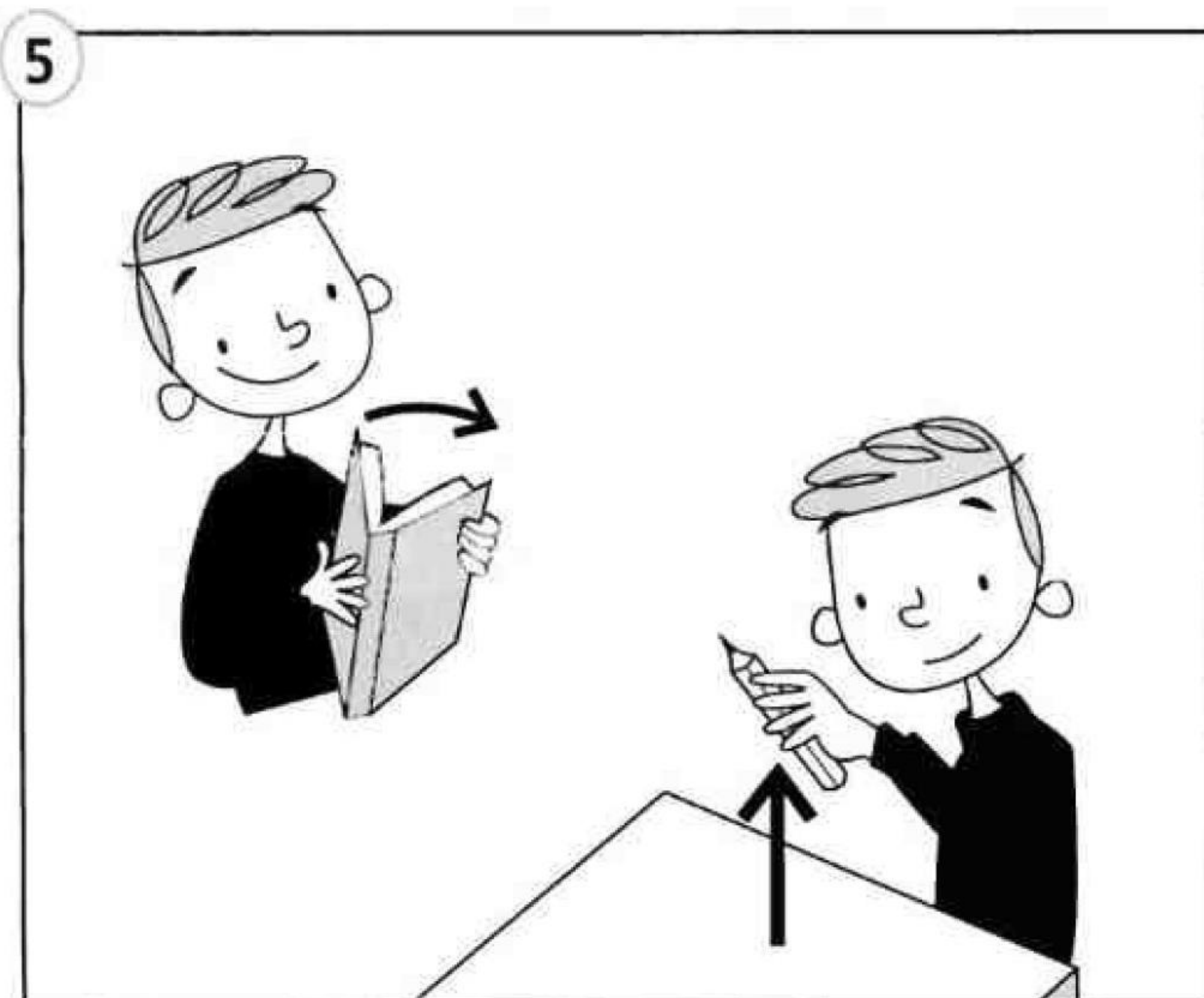
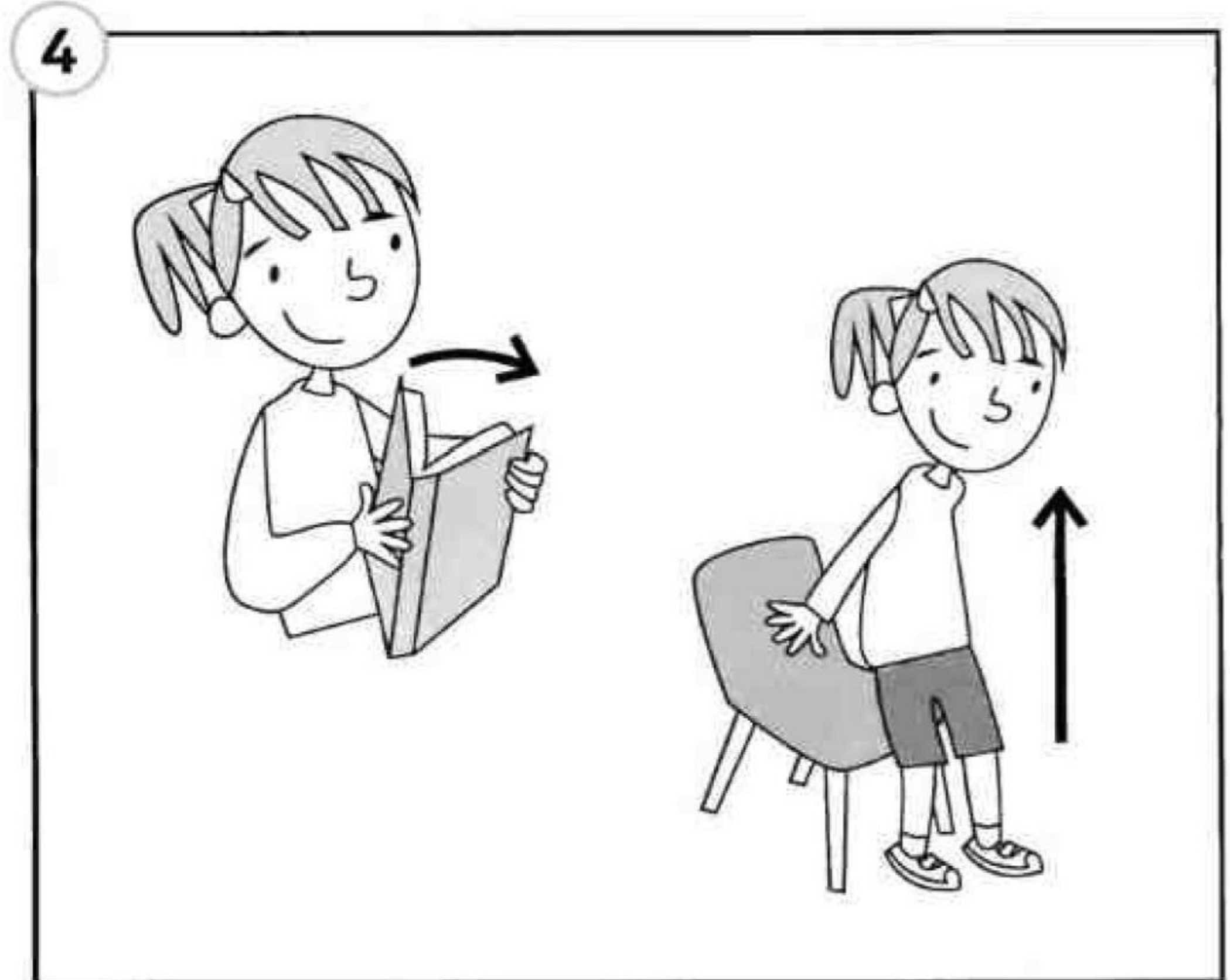
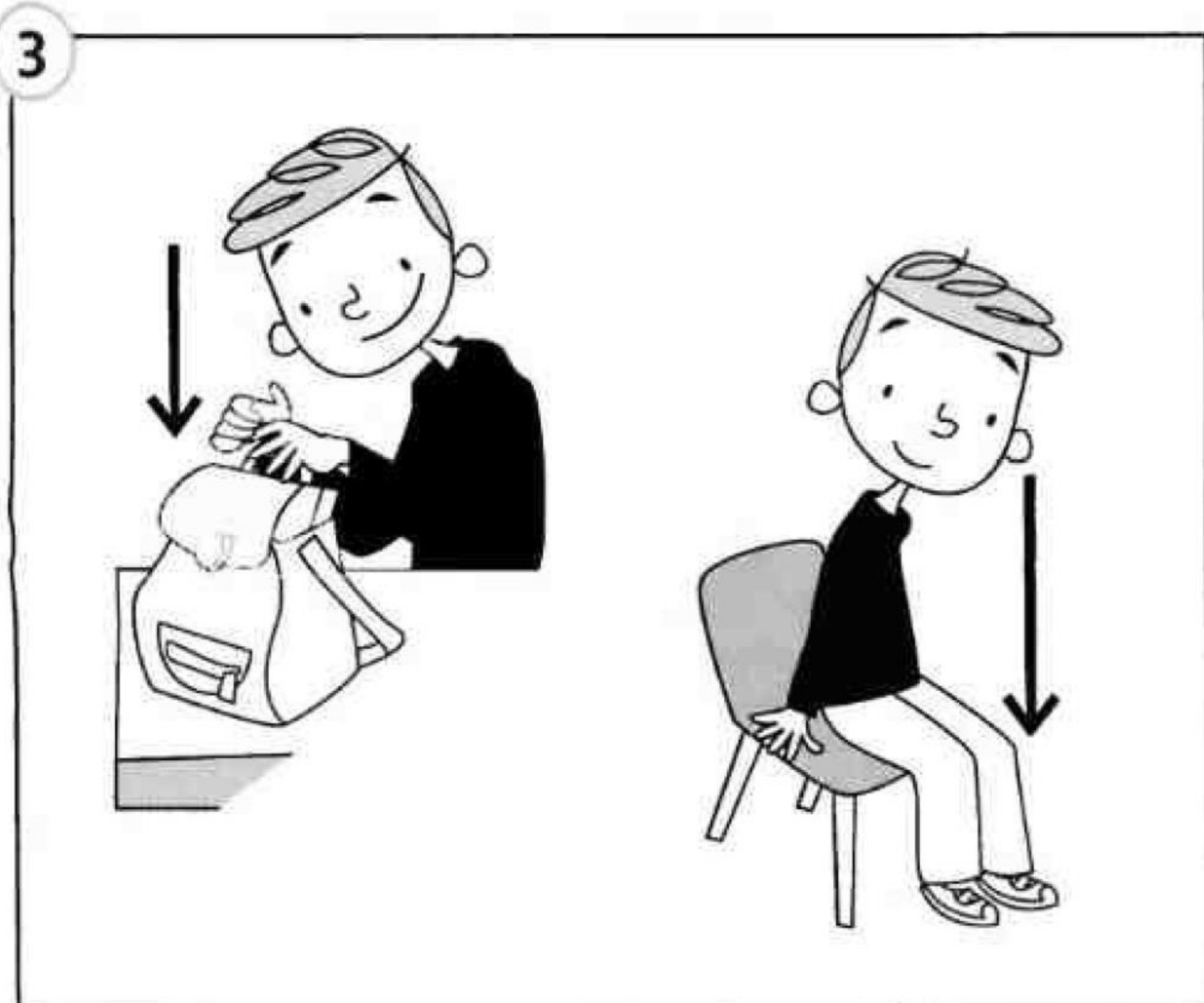
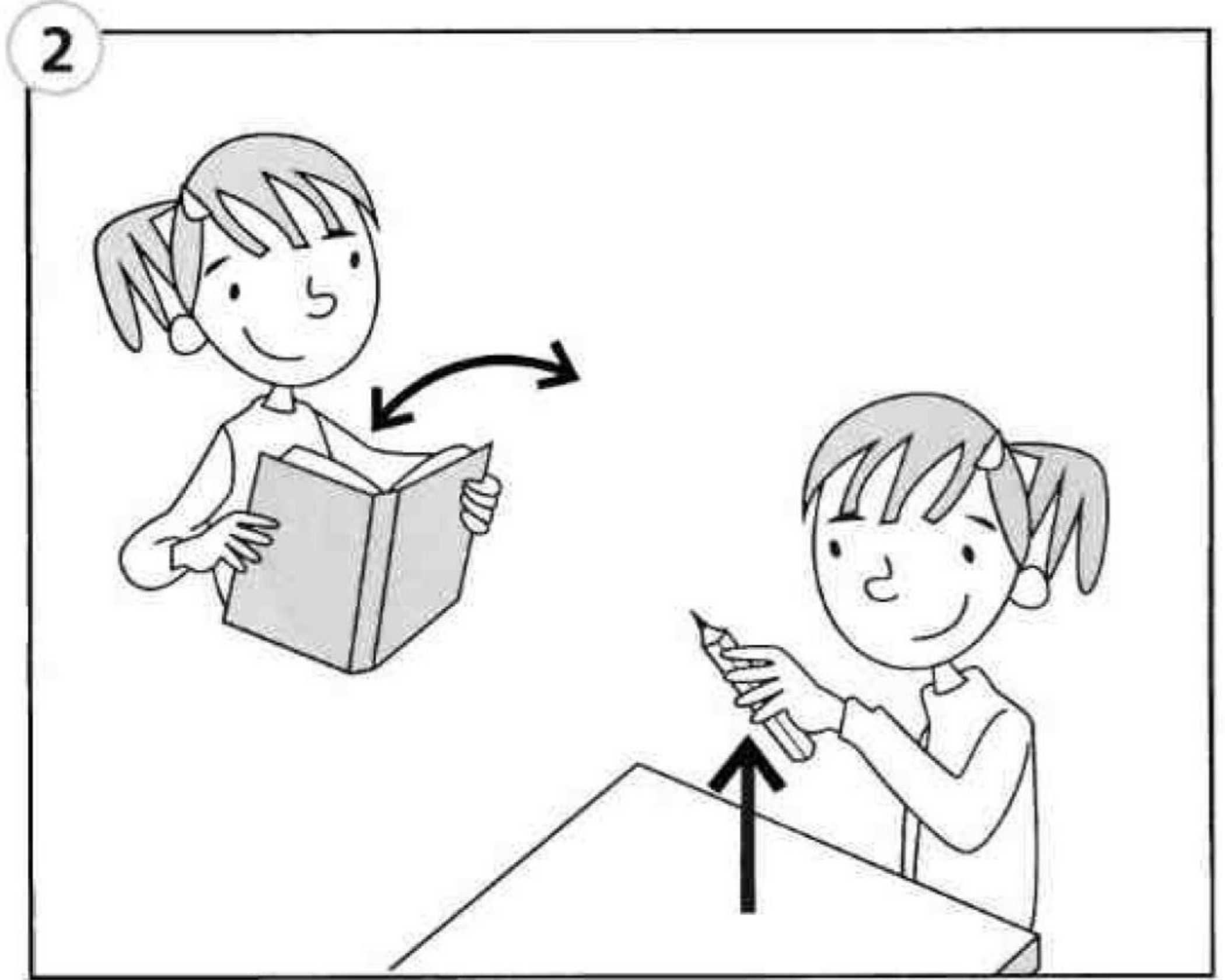
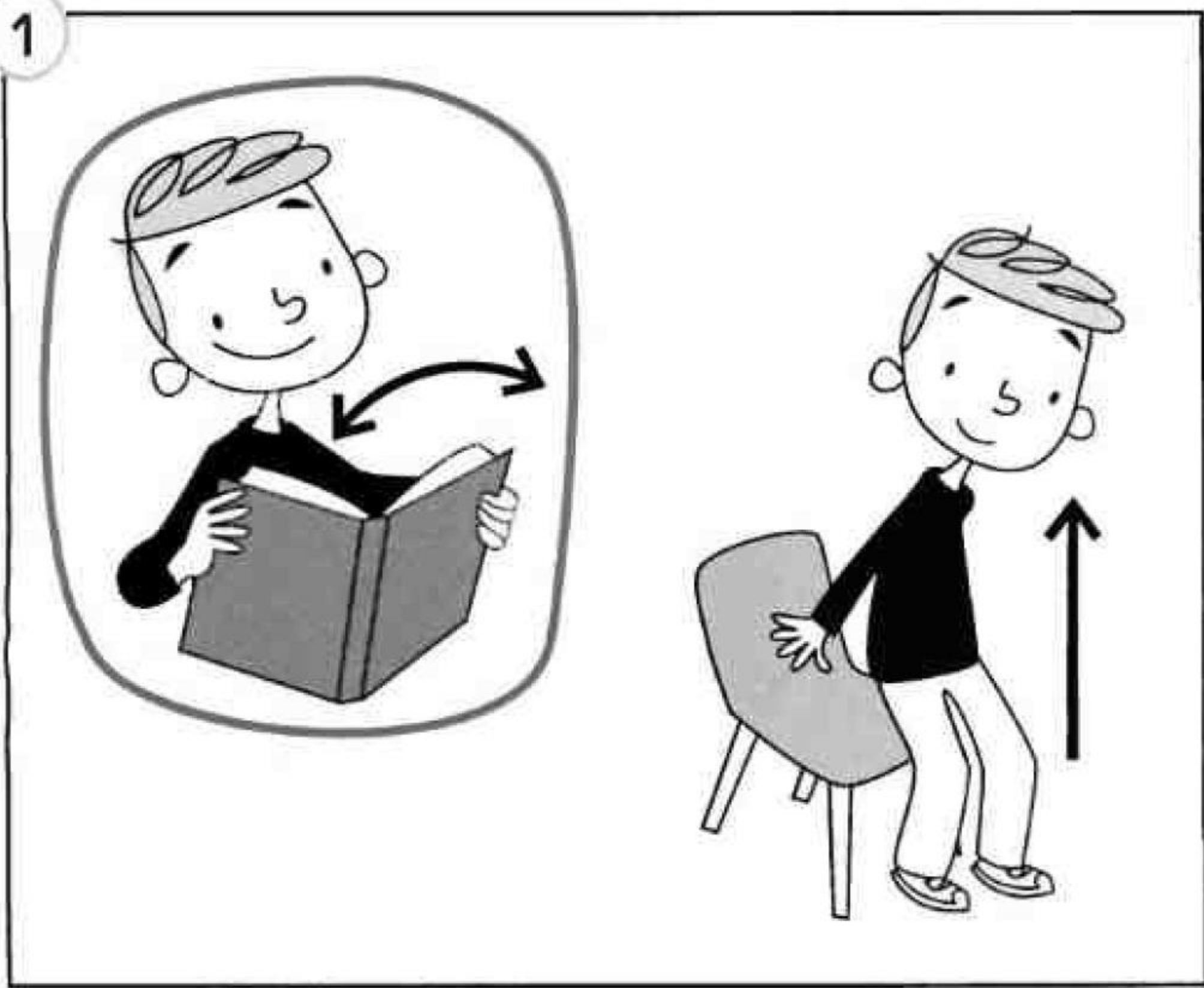

1

Draw and colour.

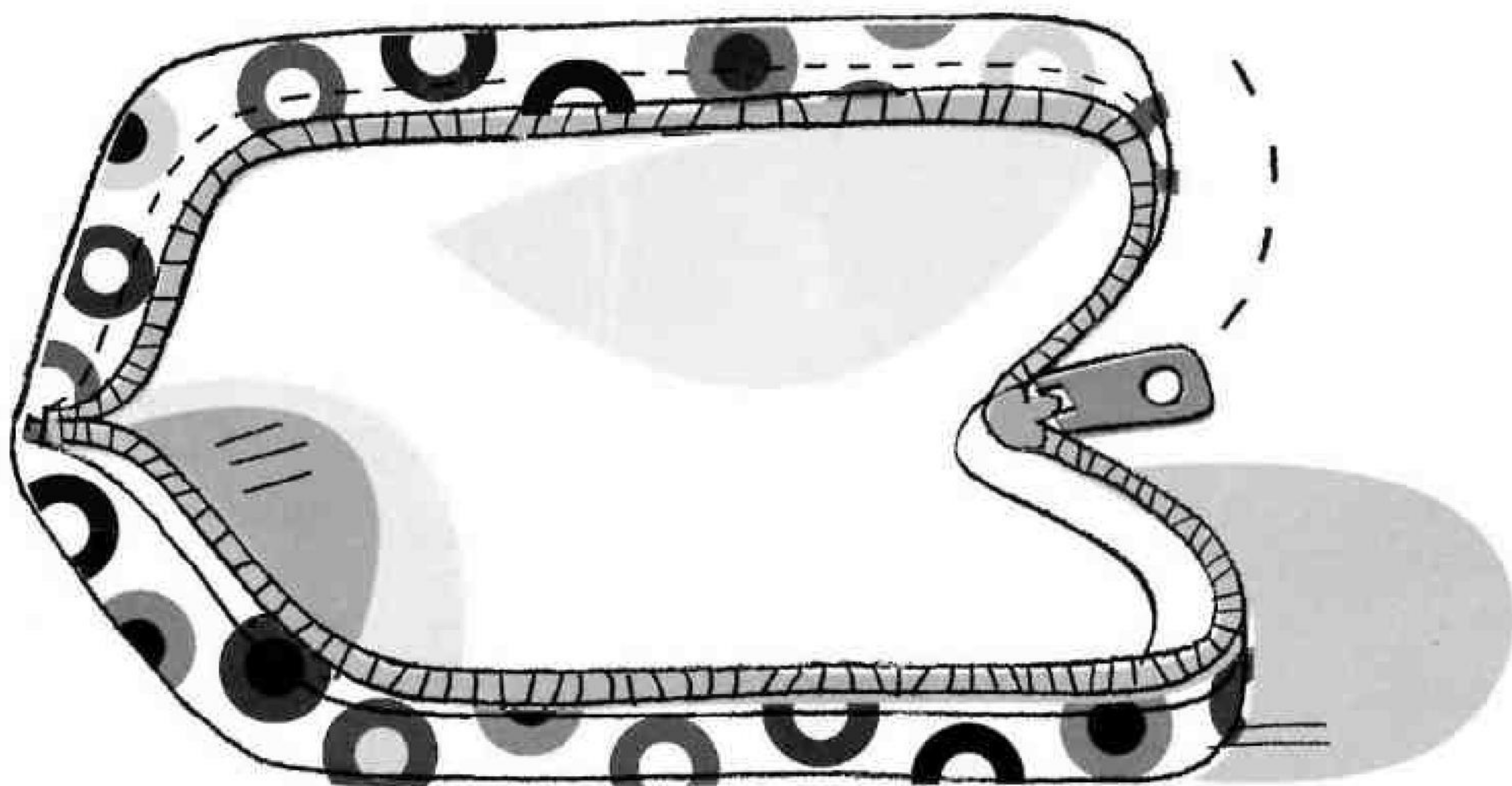
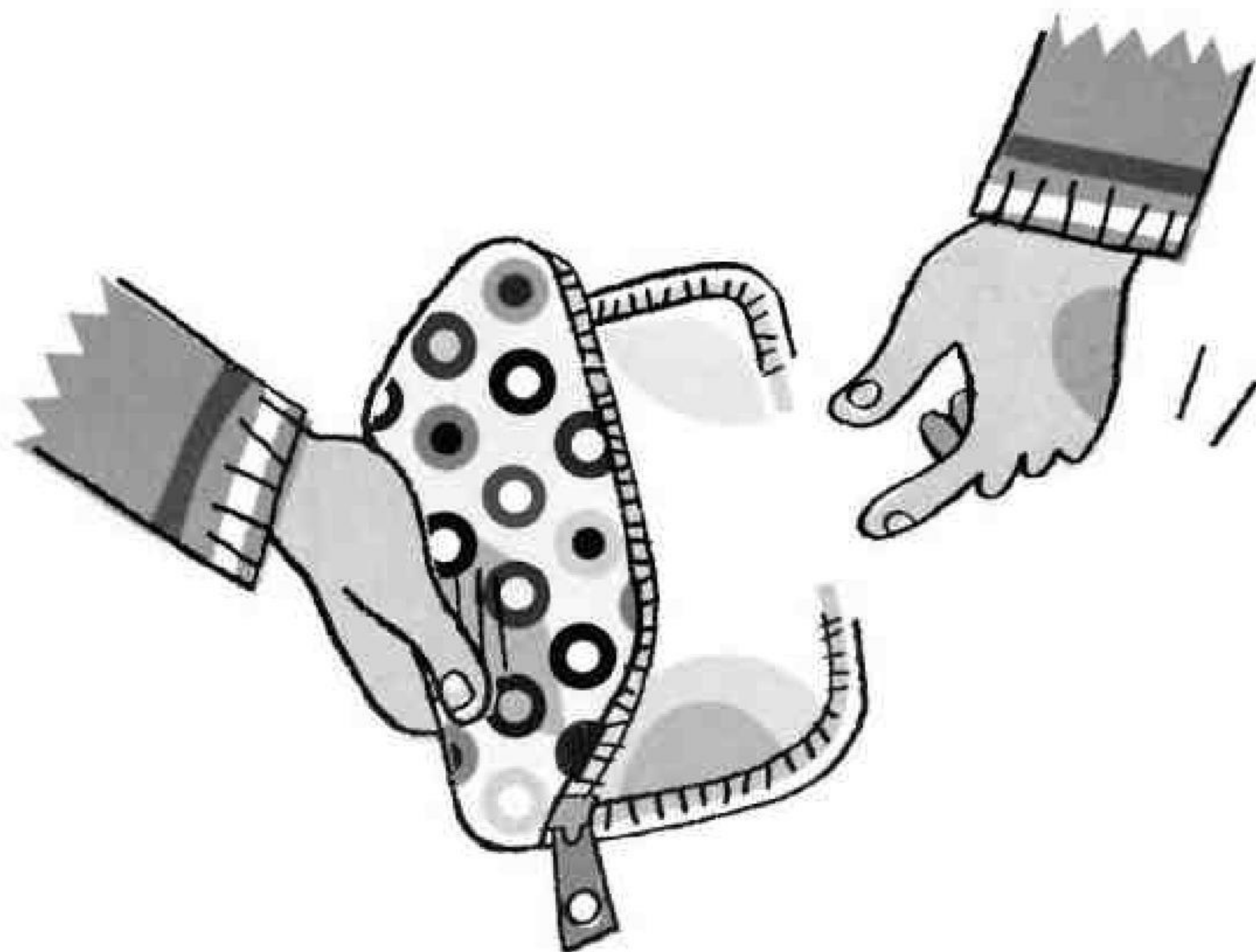
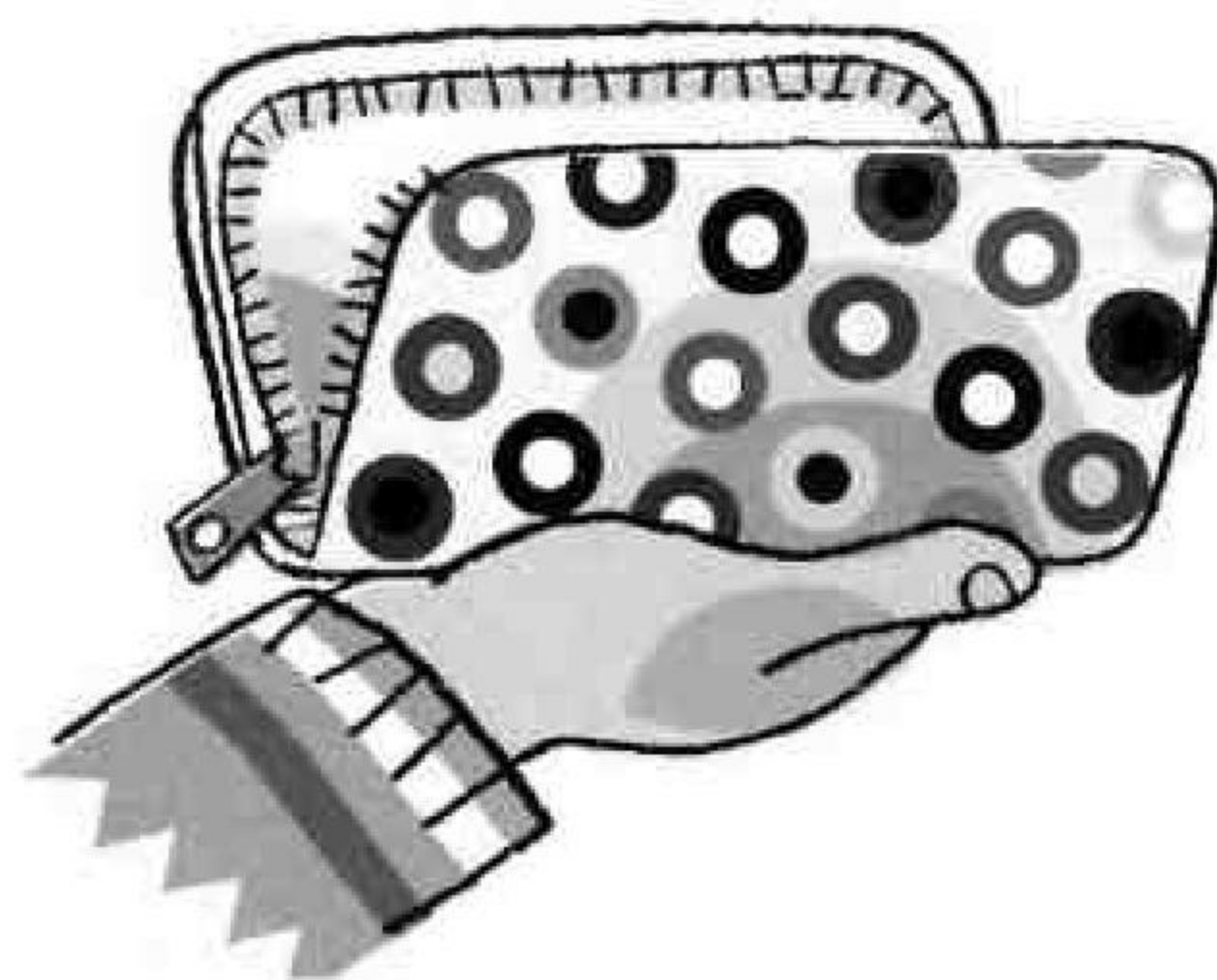
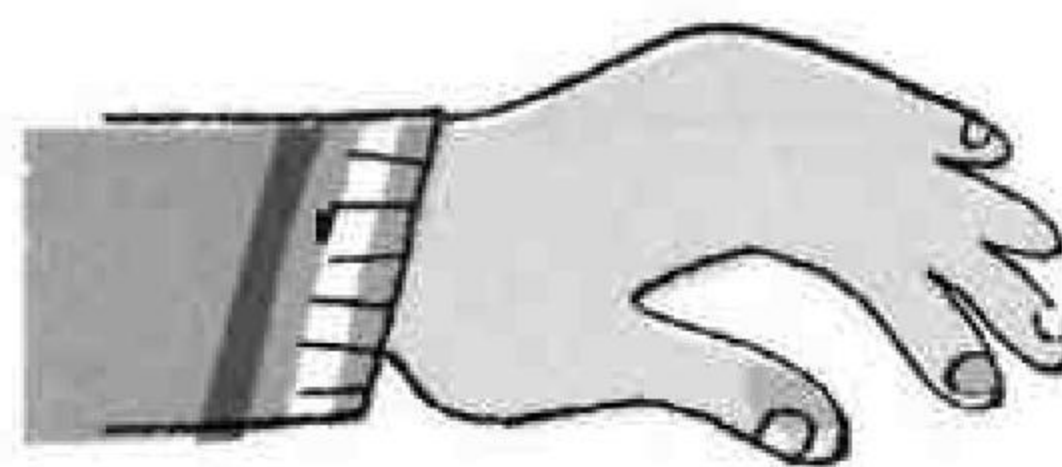

1 Think! Count and match.

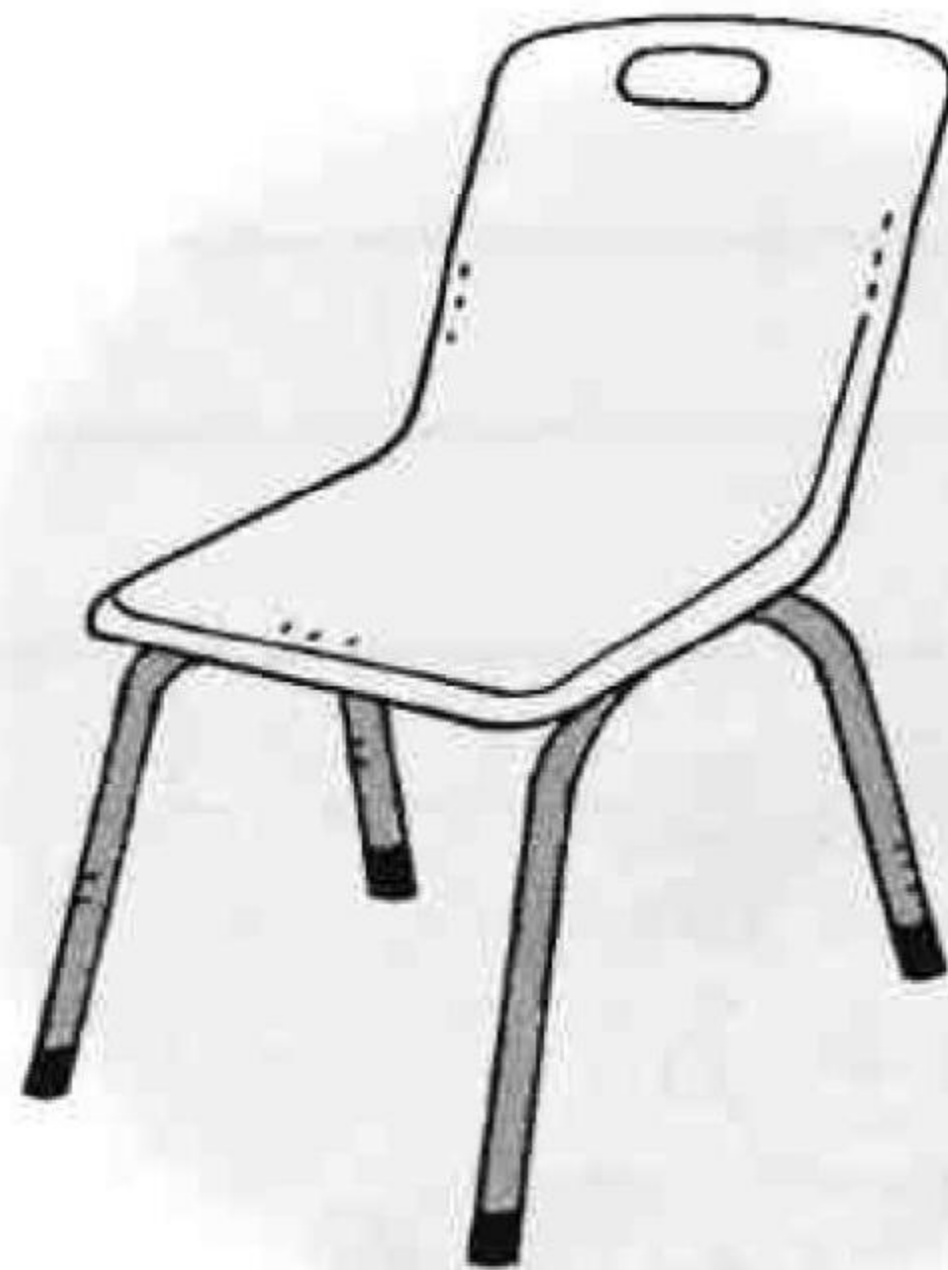
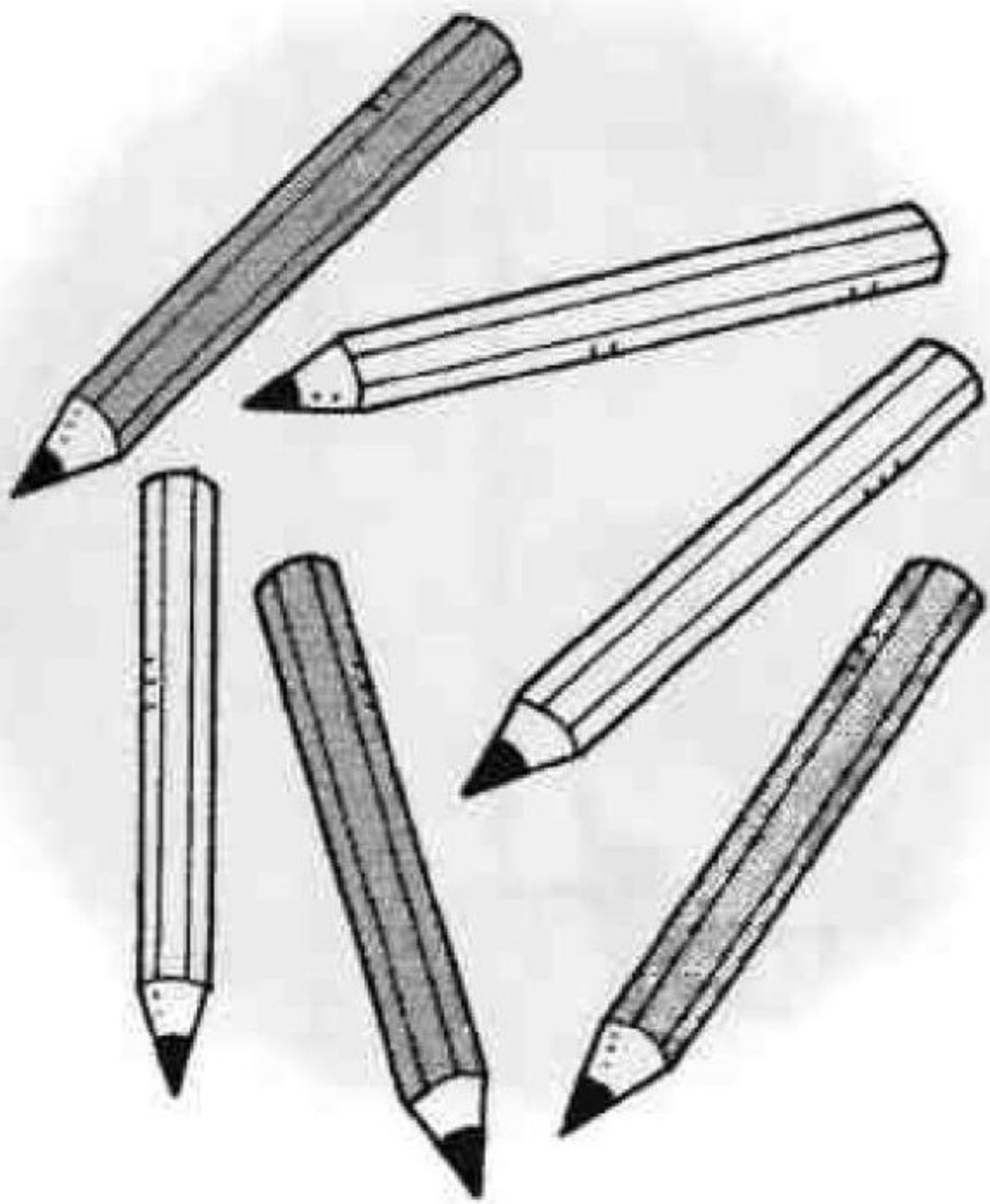
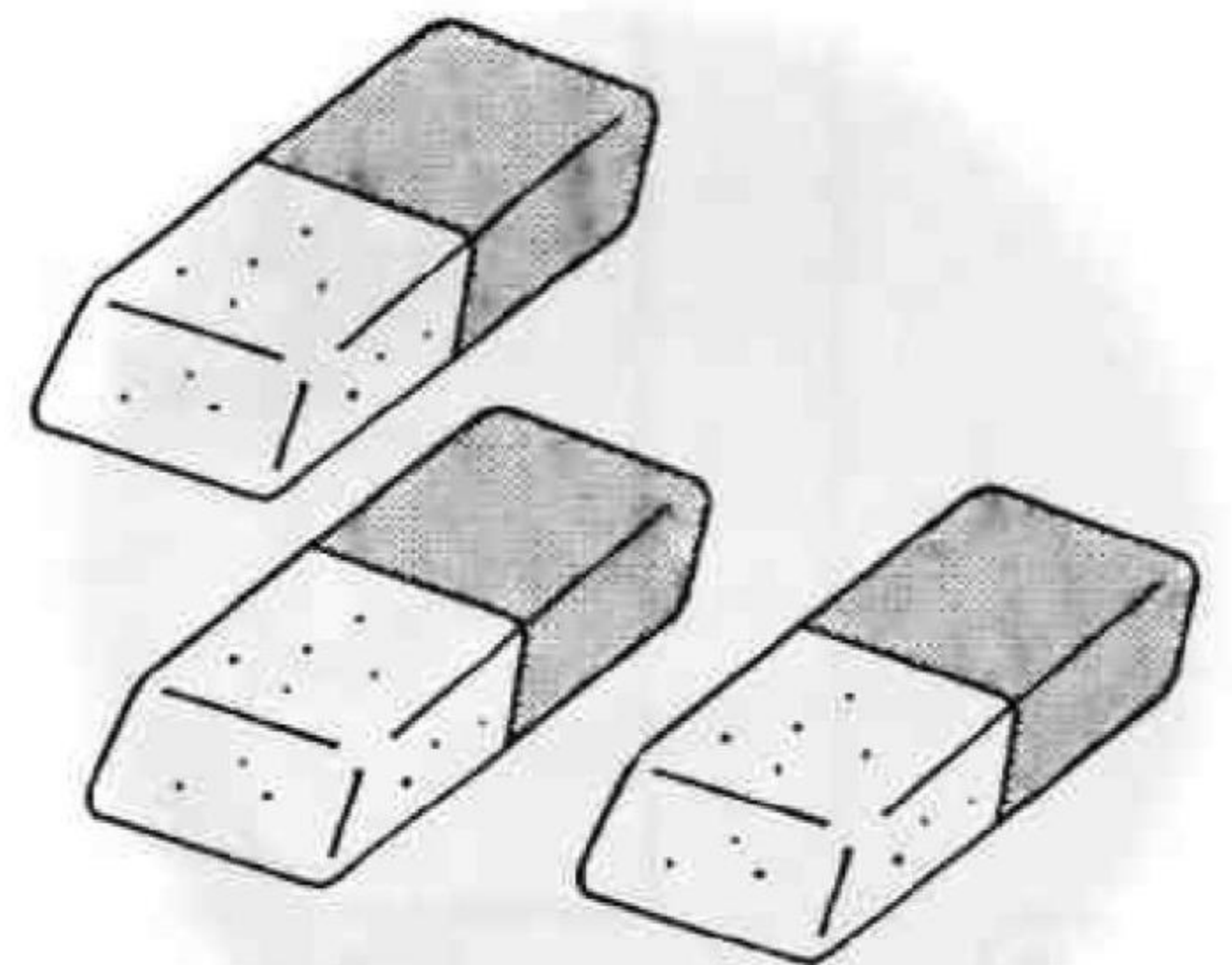
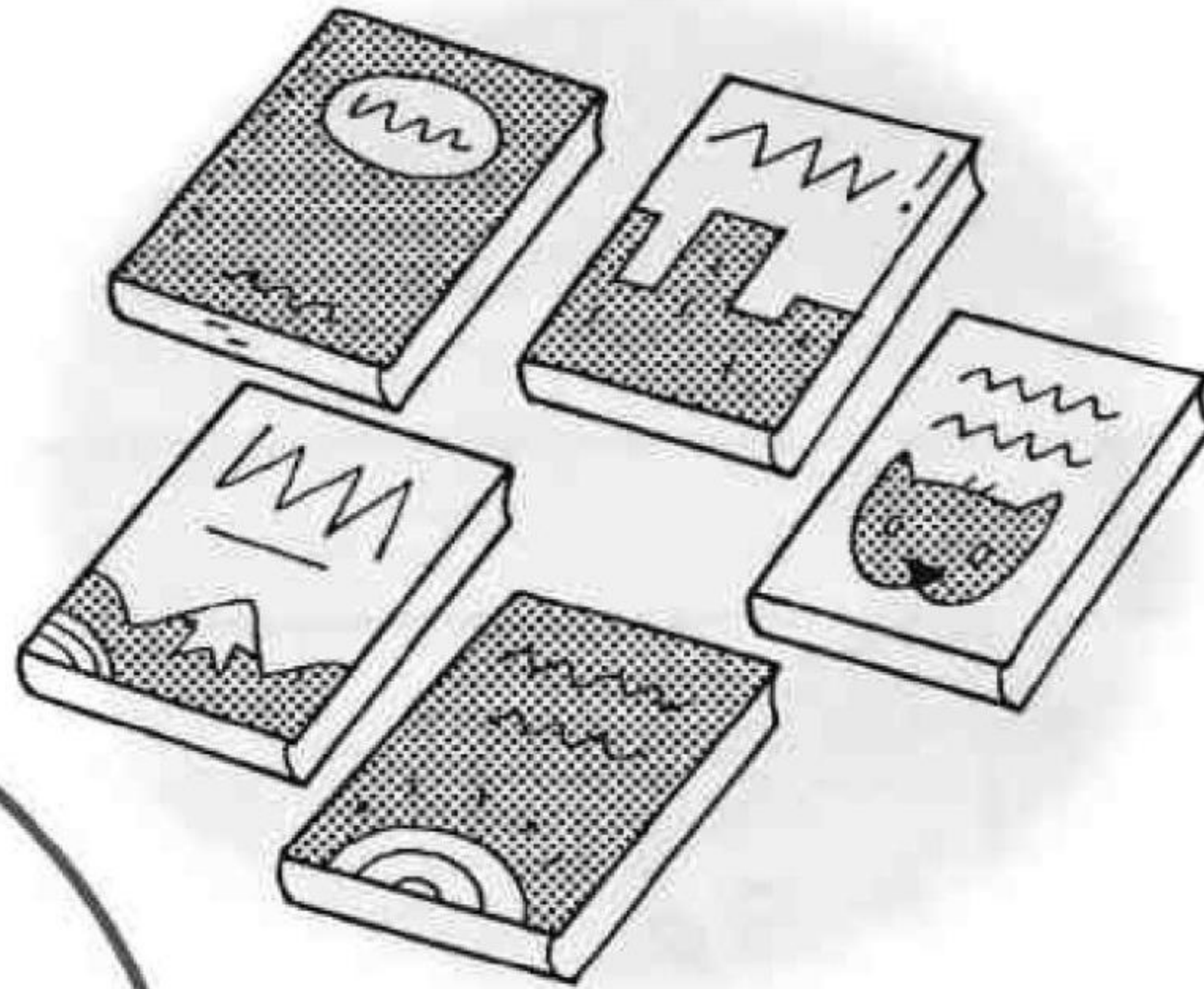
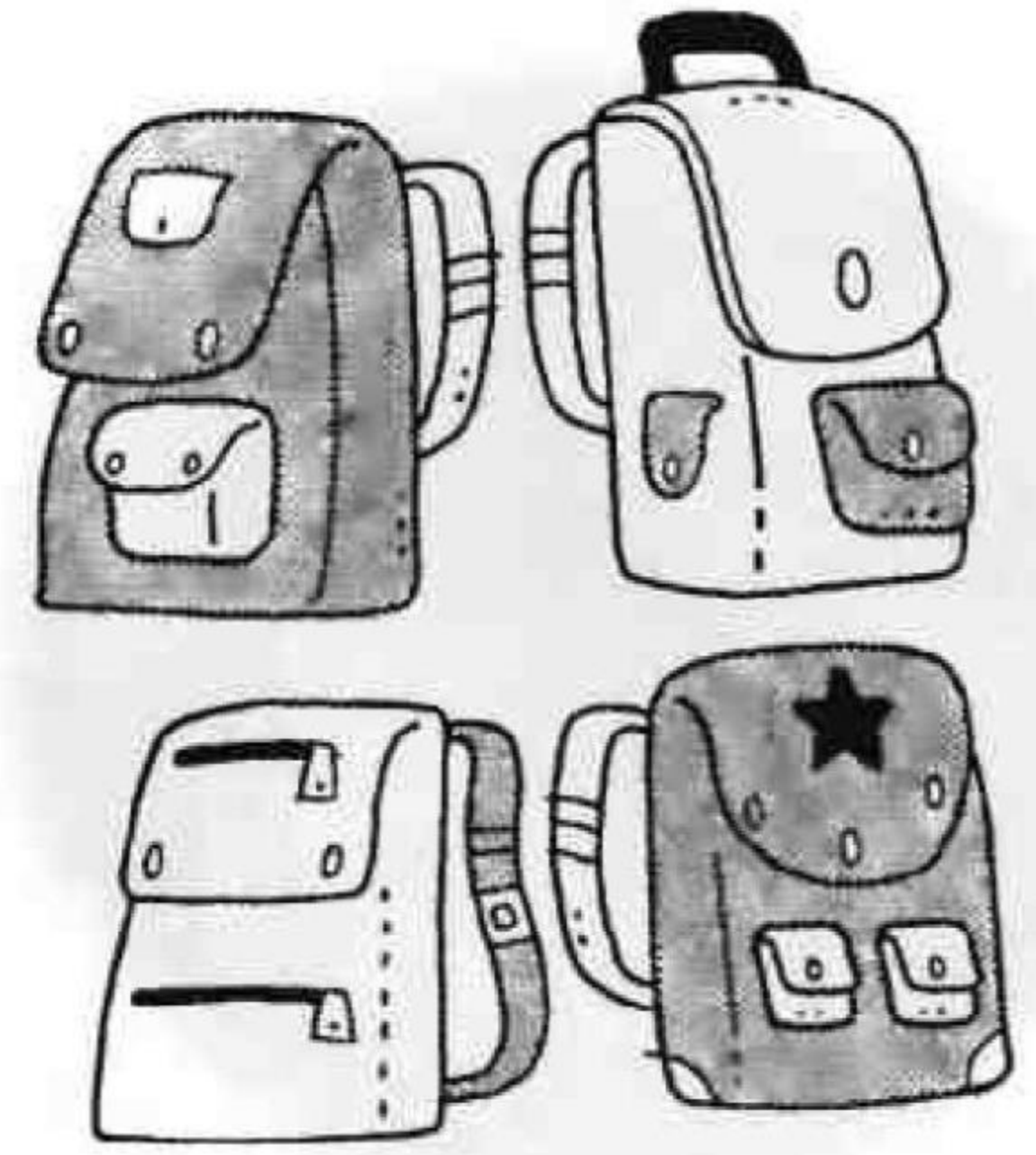
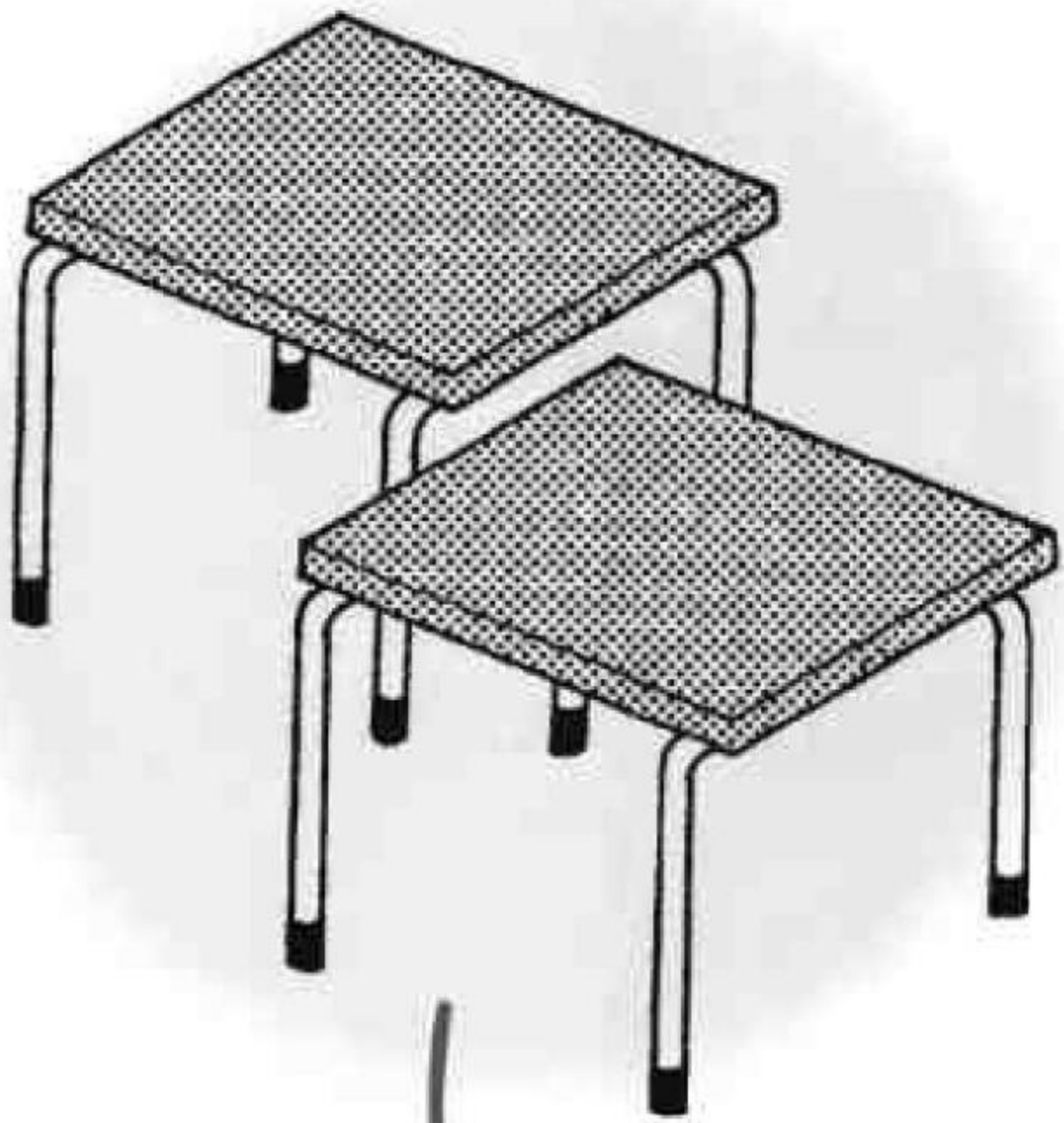

1 2 3 4 5 6

Listen and trace.

1



2

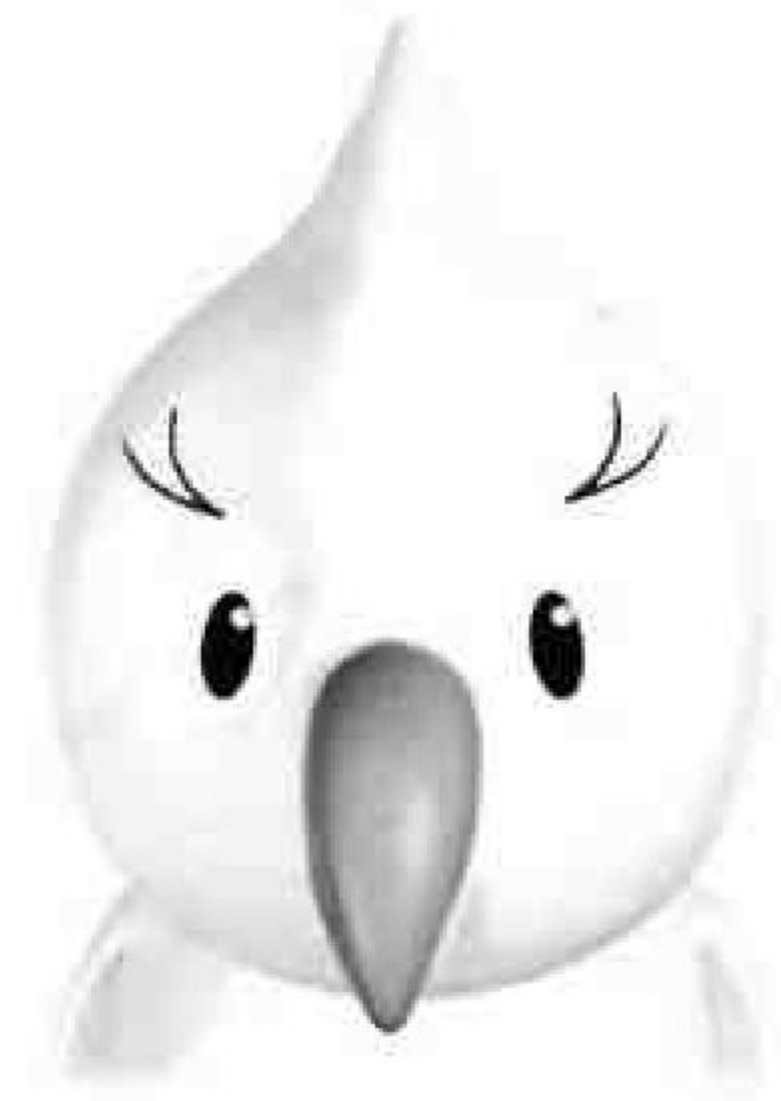

3

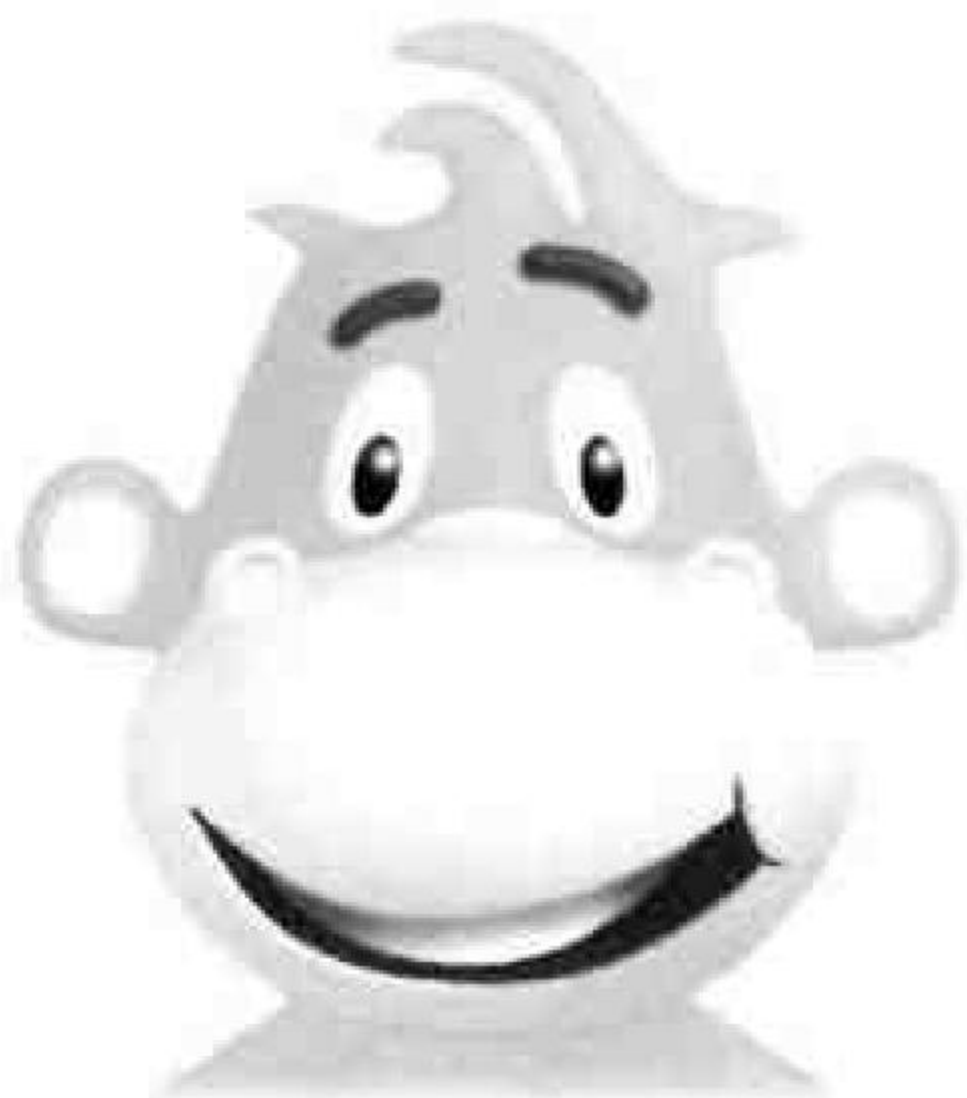

4



1 Think! Look and colour.



1

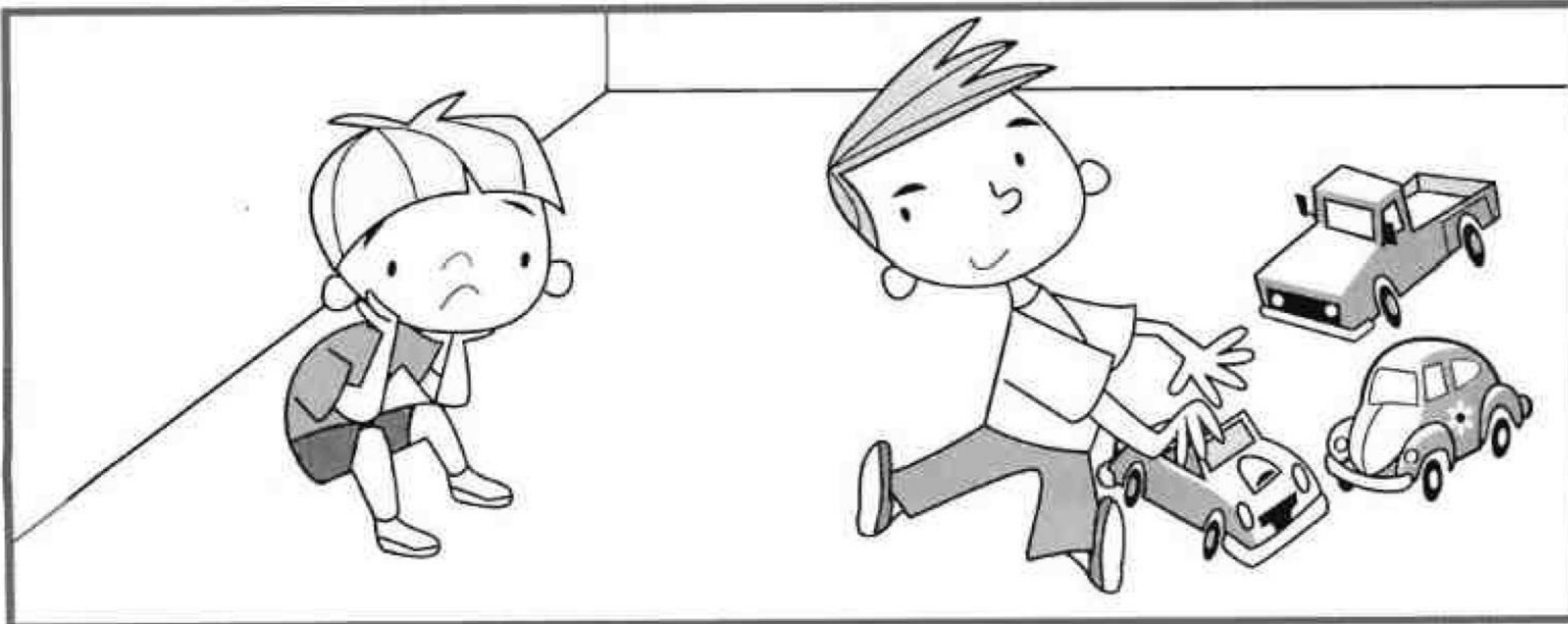

2

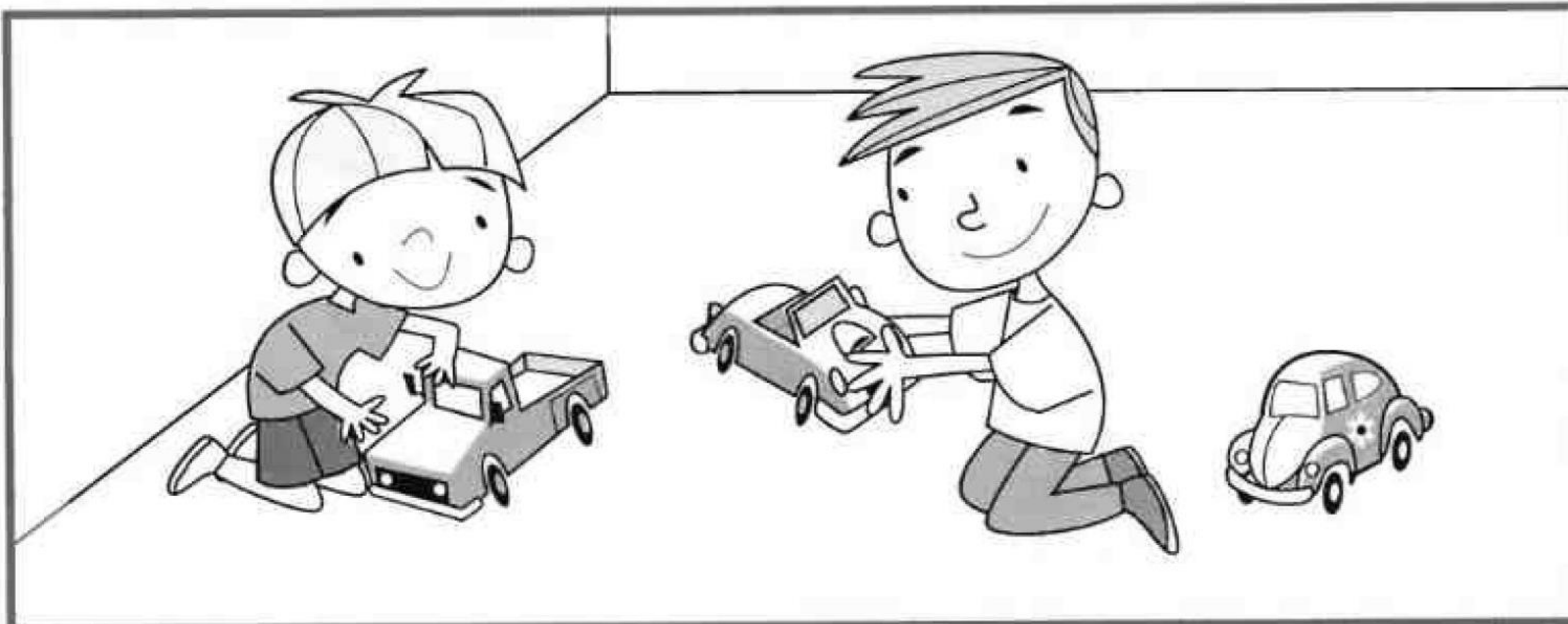

Listen and colour. Colour to match.

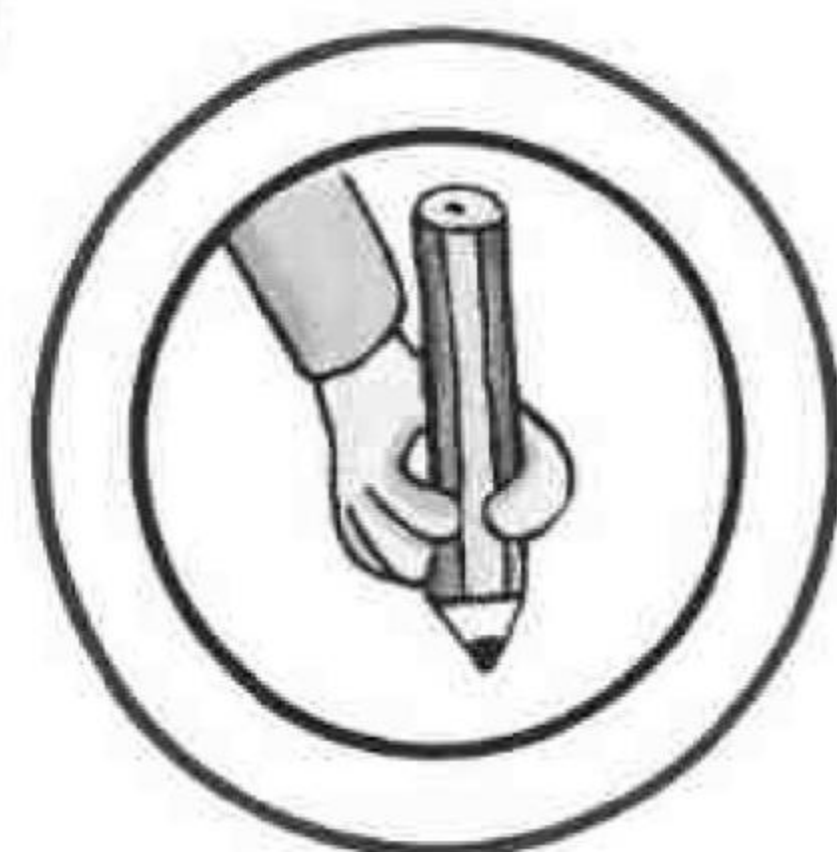
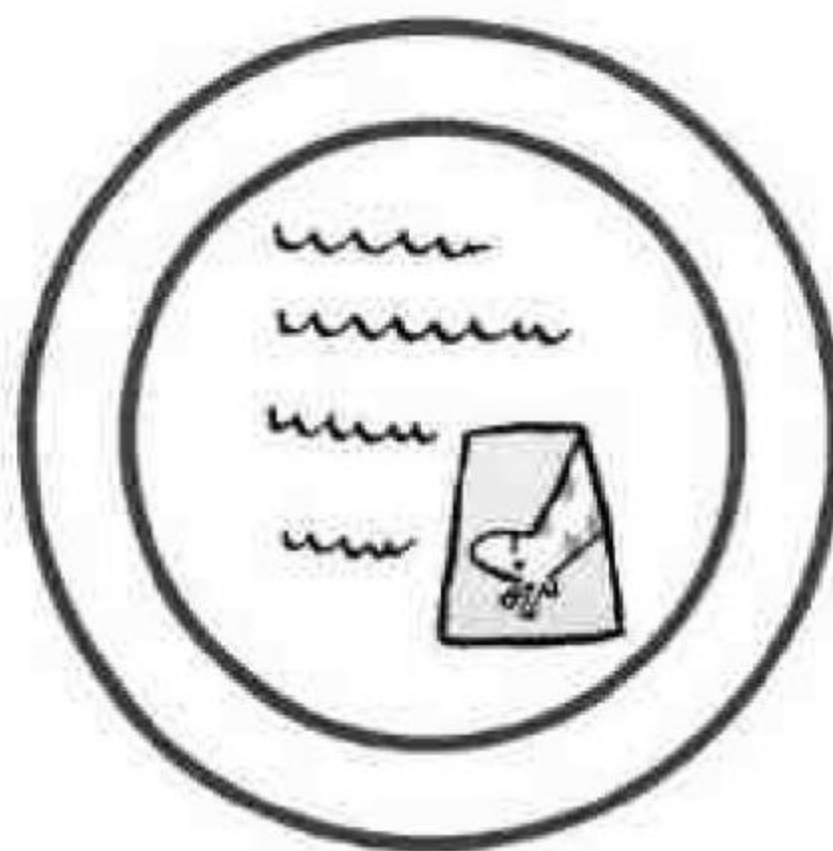
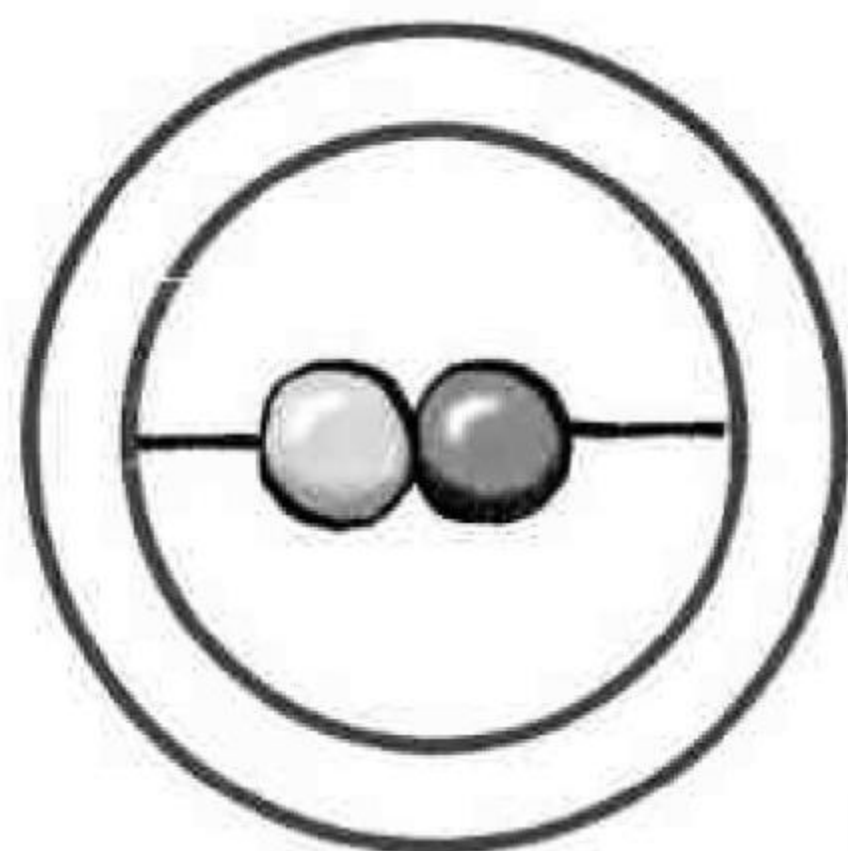
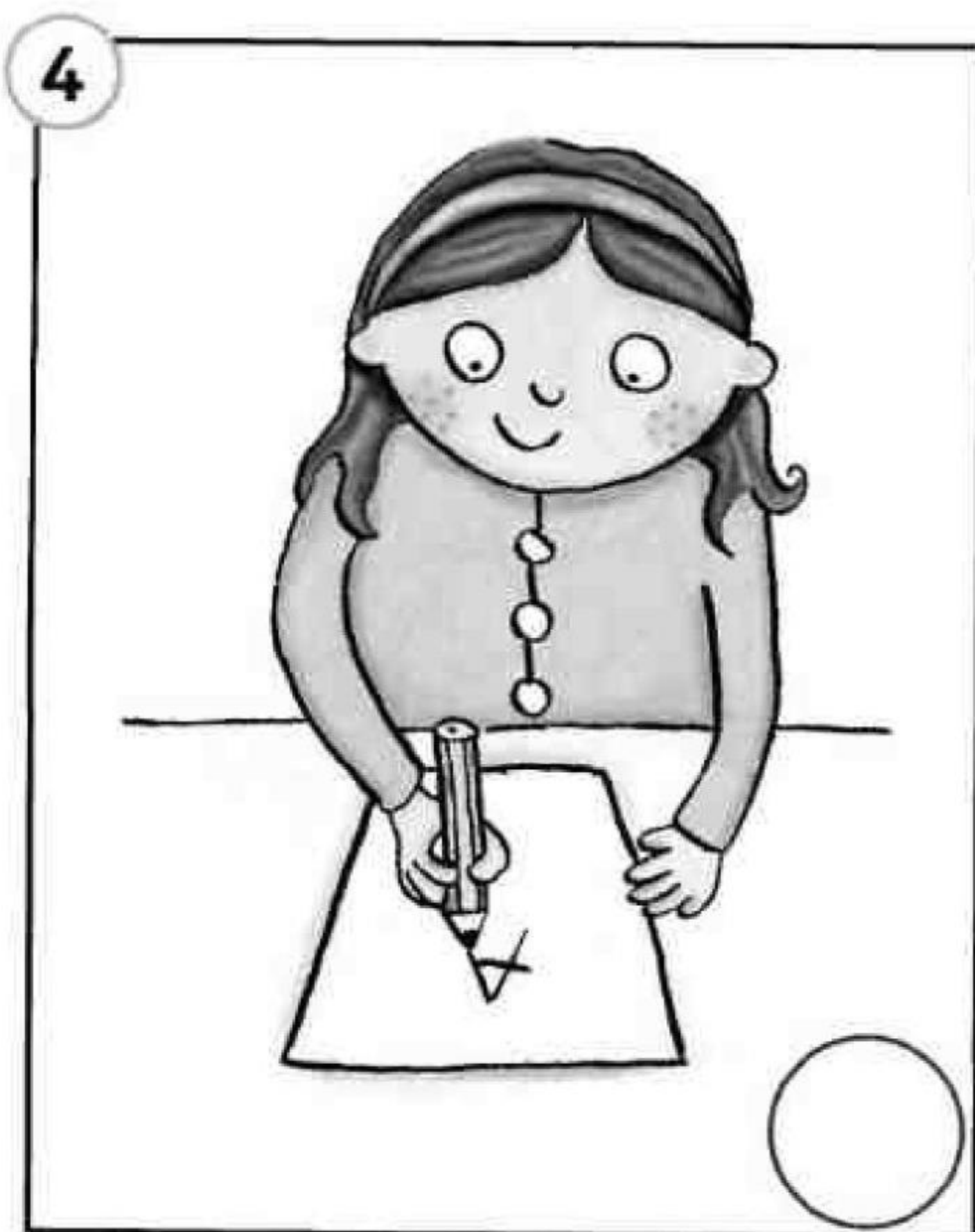
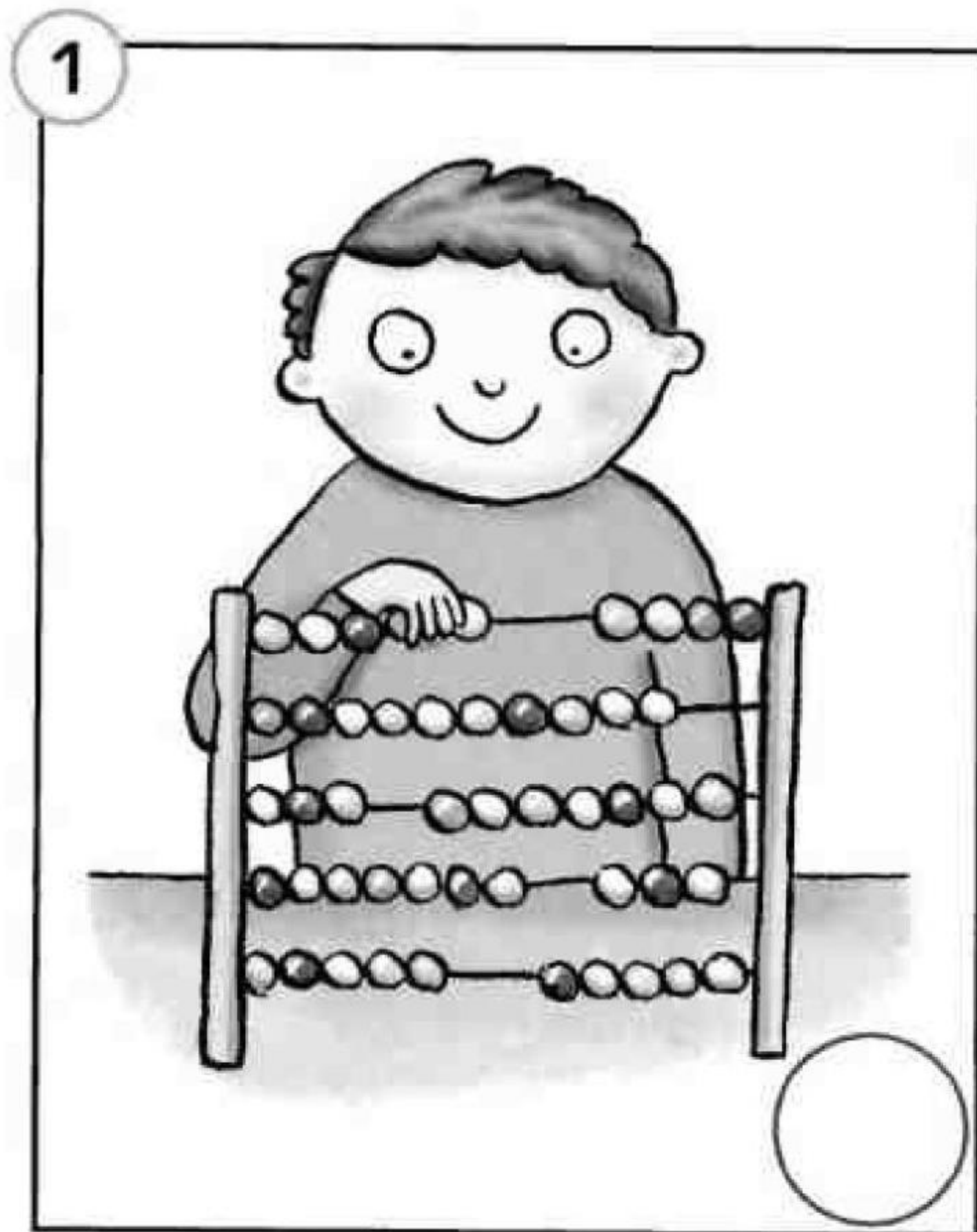

1 Look and circle.

1



2

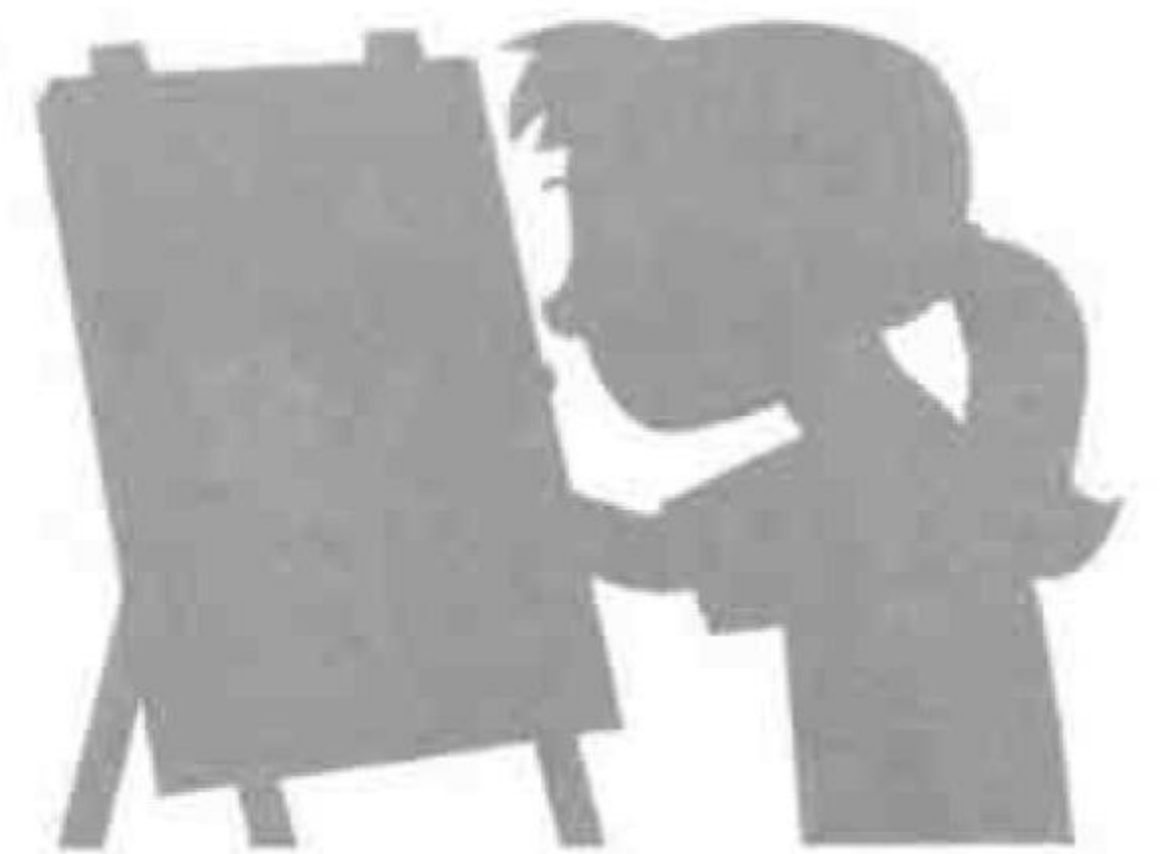
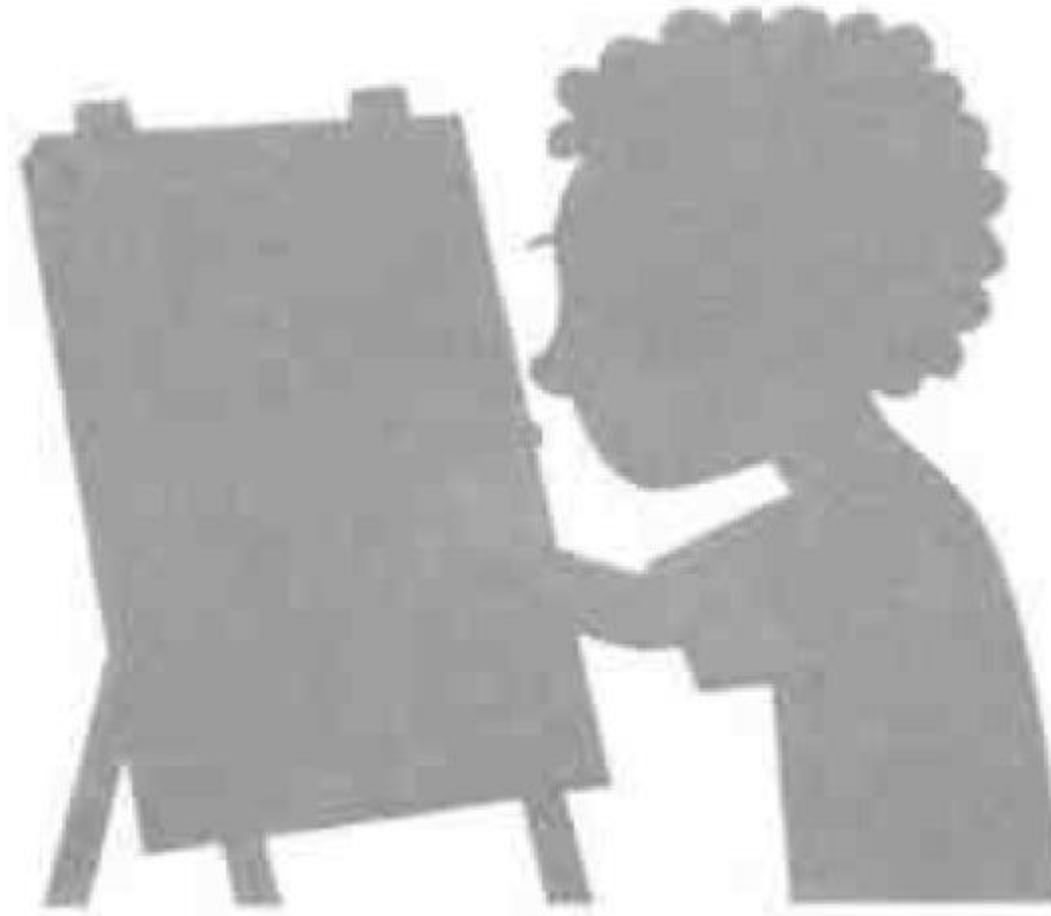
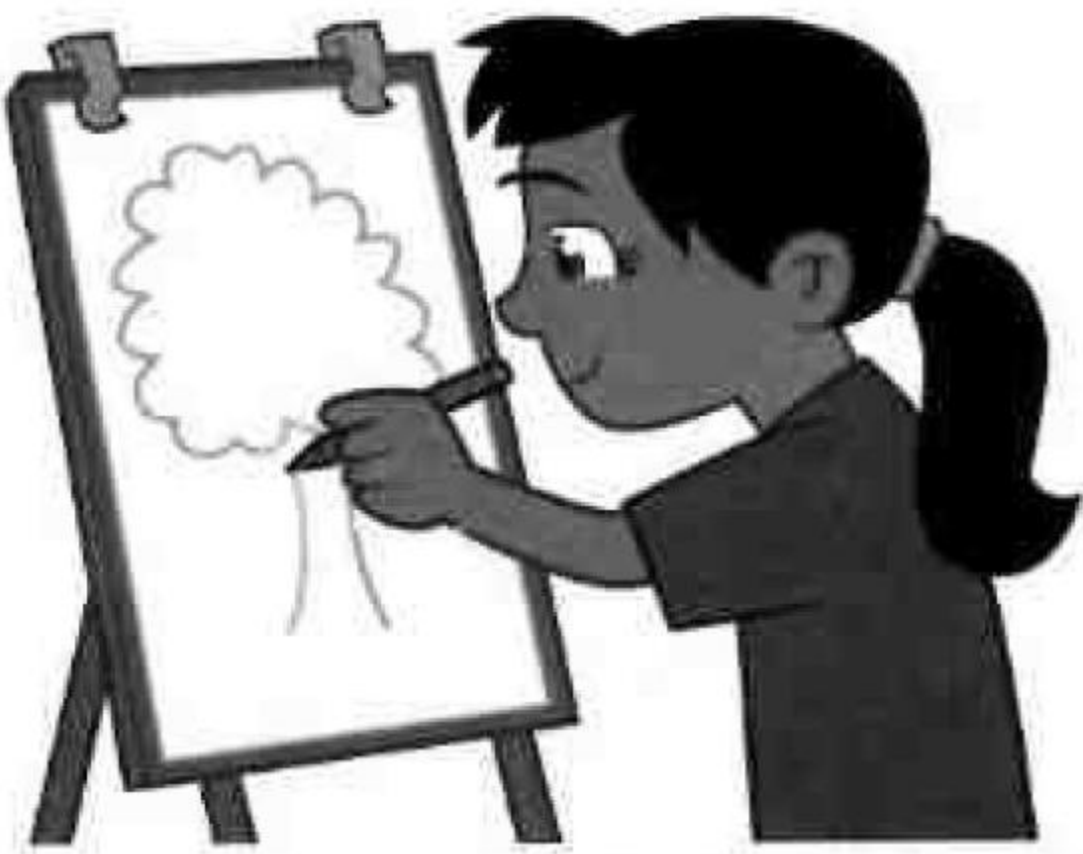

3



4



5

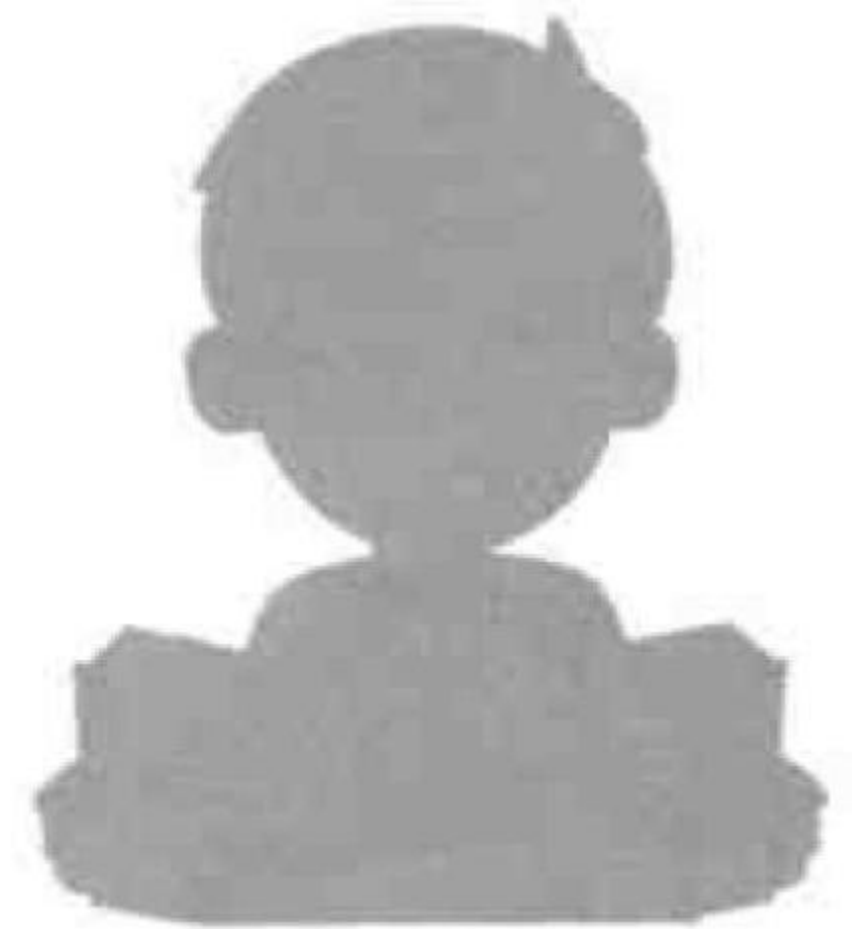

1 Say the words. Colour the circles.

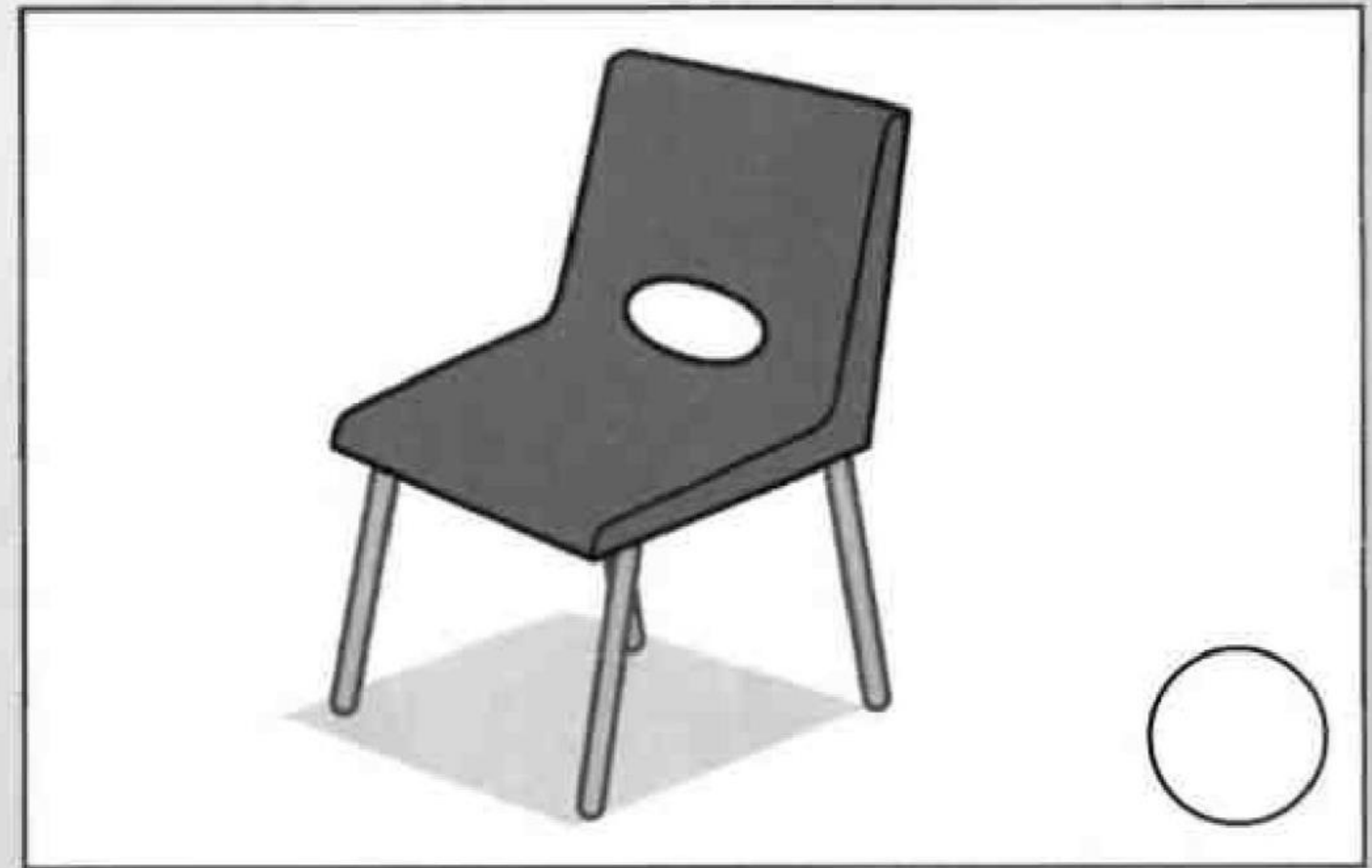
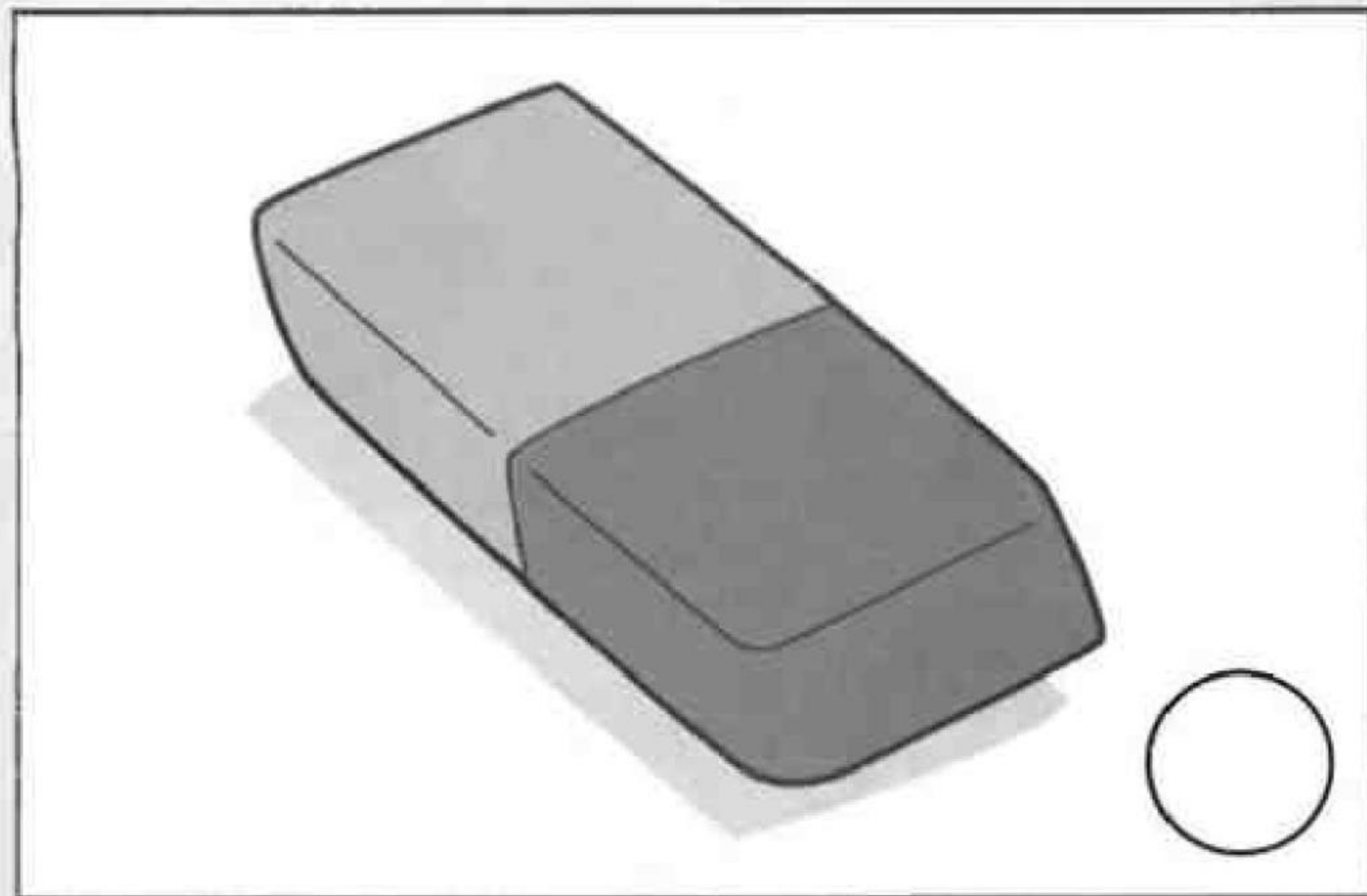
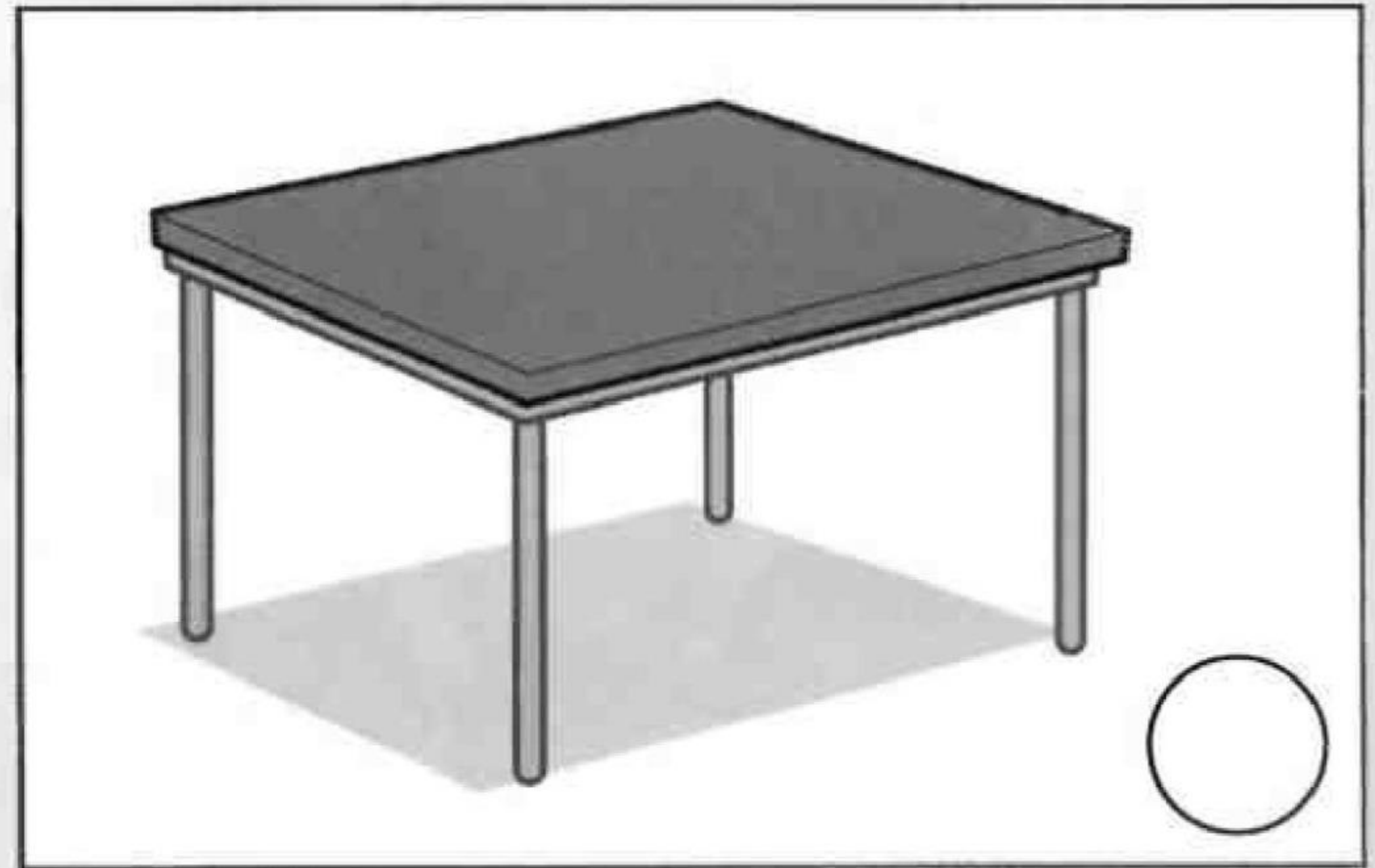
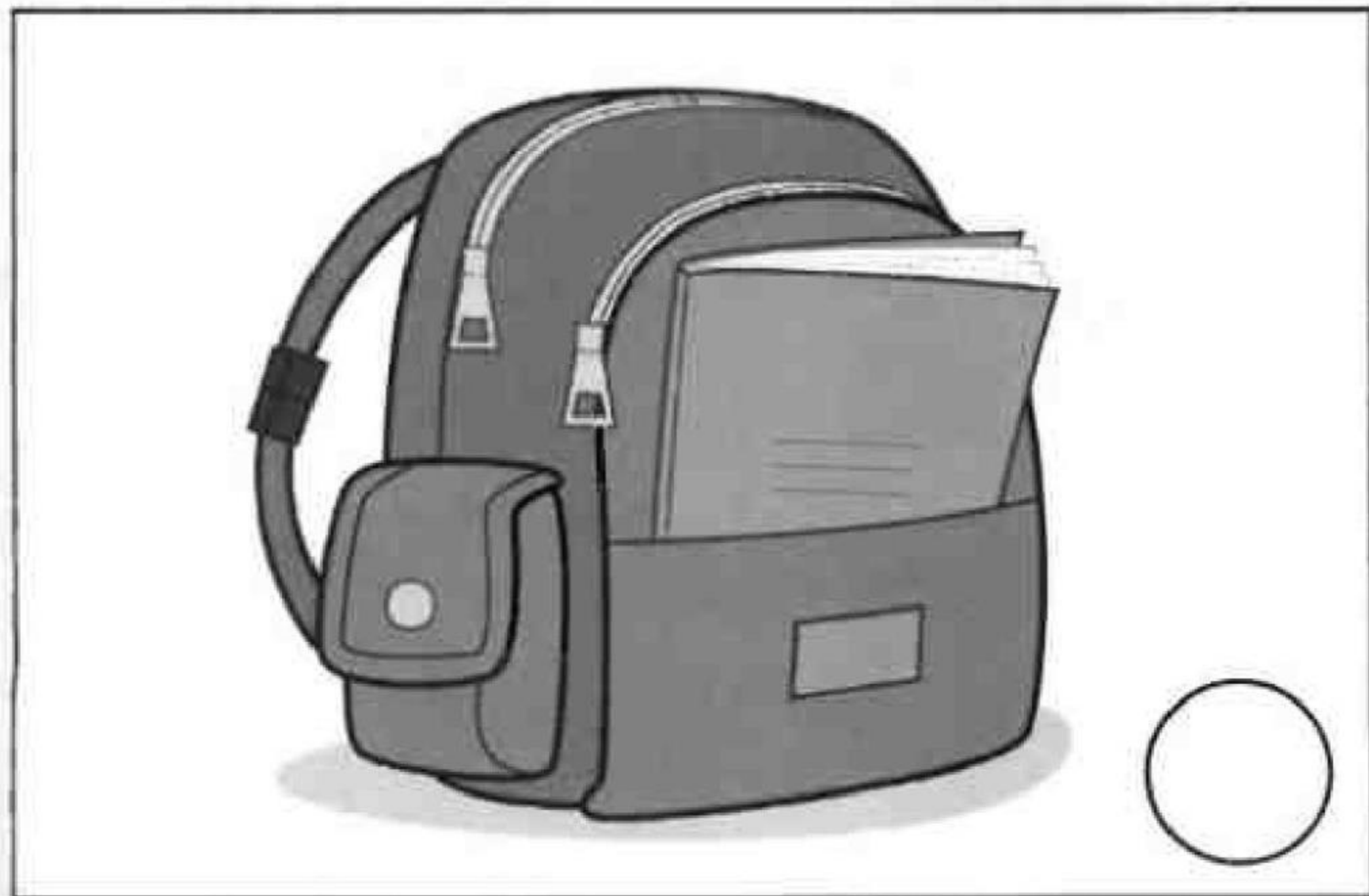
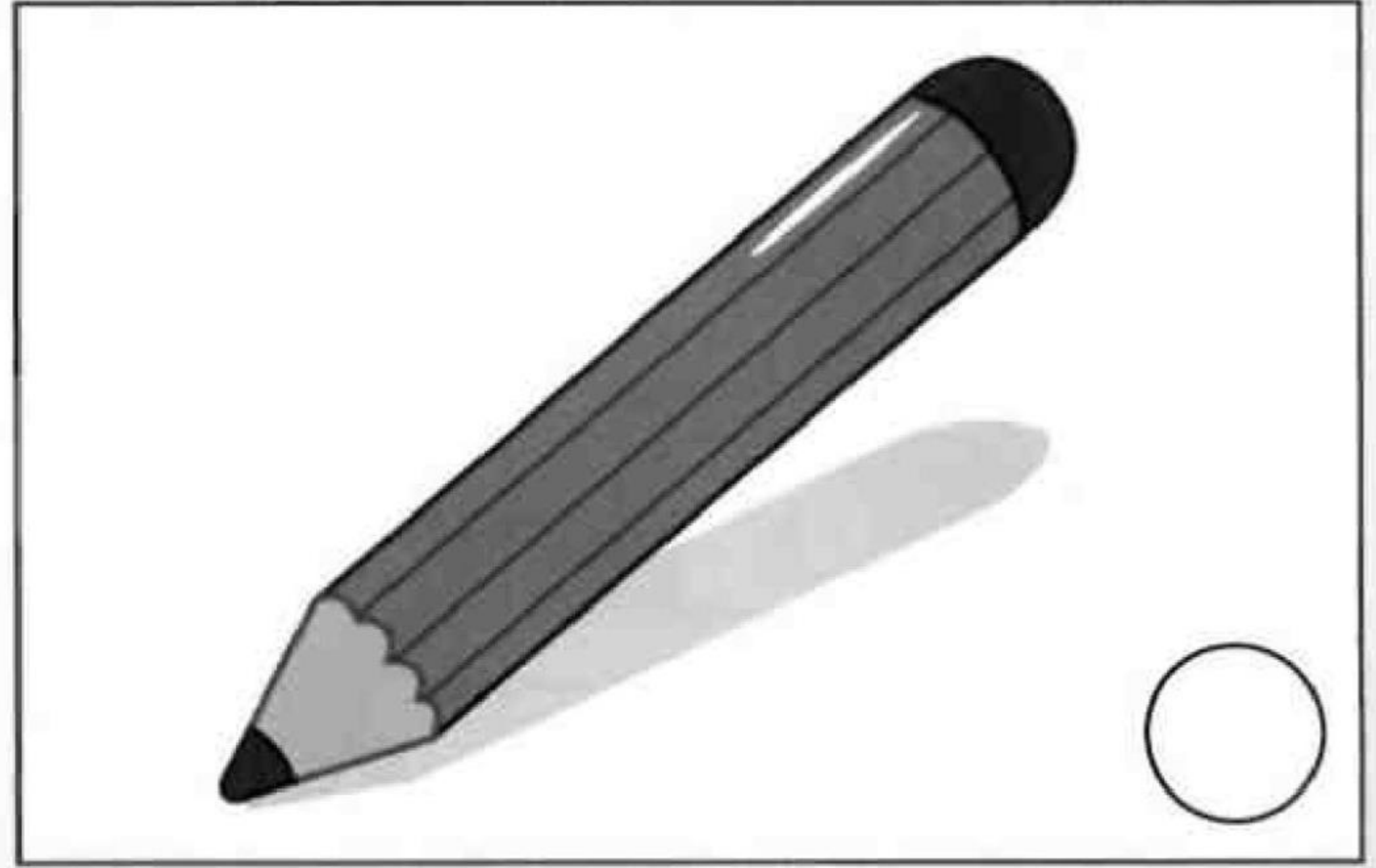

2 Draw faces. 😊 😐 😞

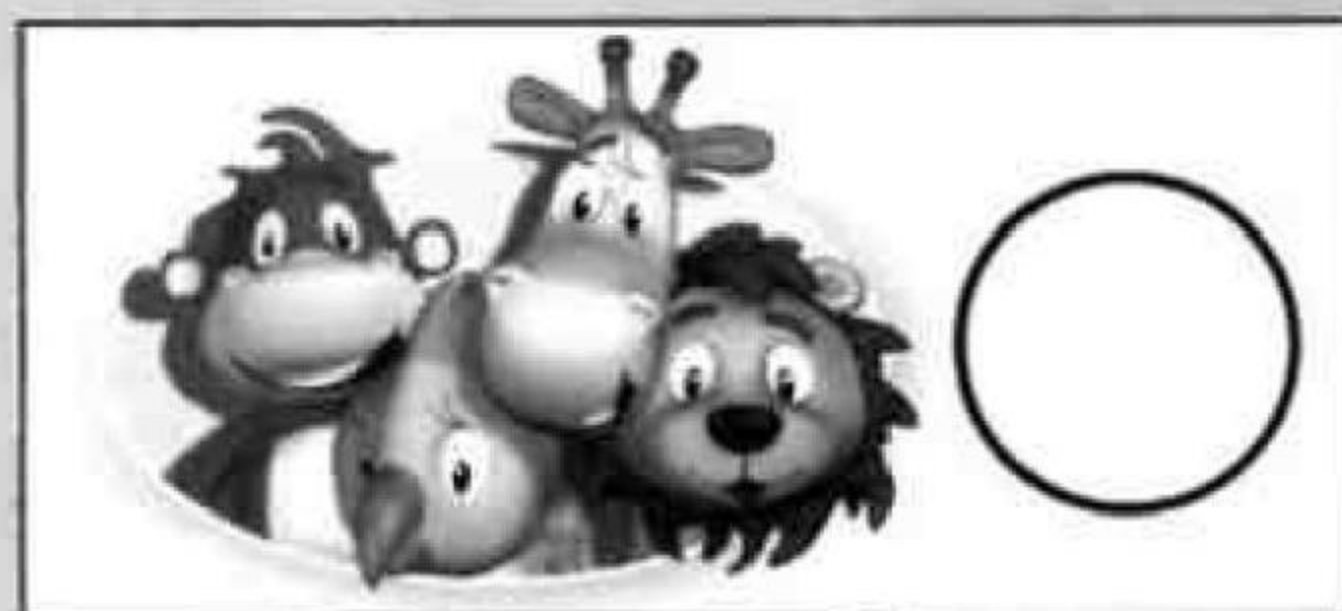

2

My family

1

Circle and say the words.

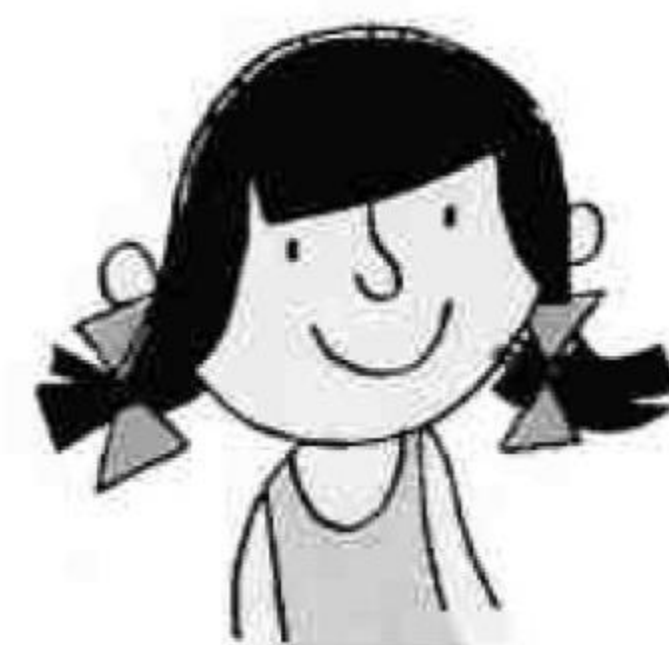
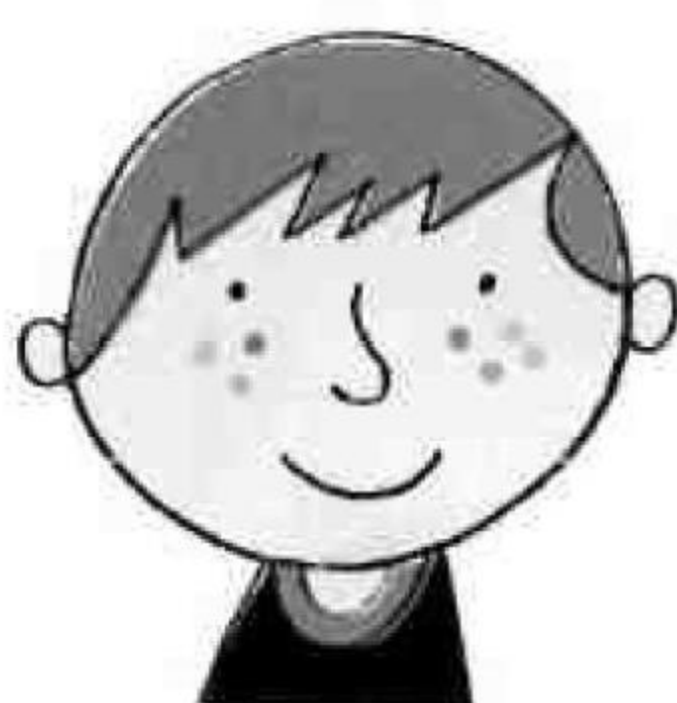

1 CD1 26 Listen and circle.

1

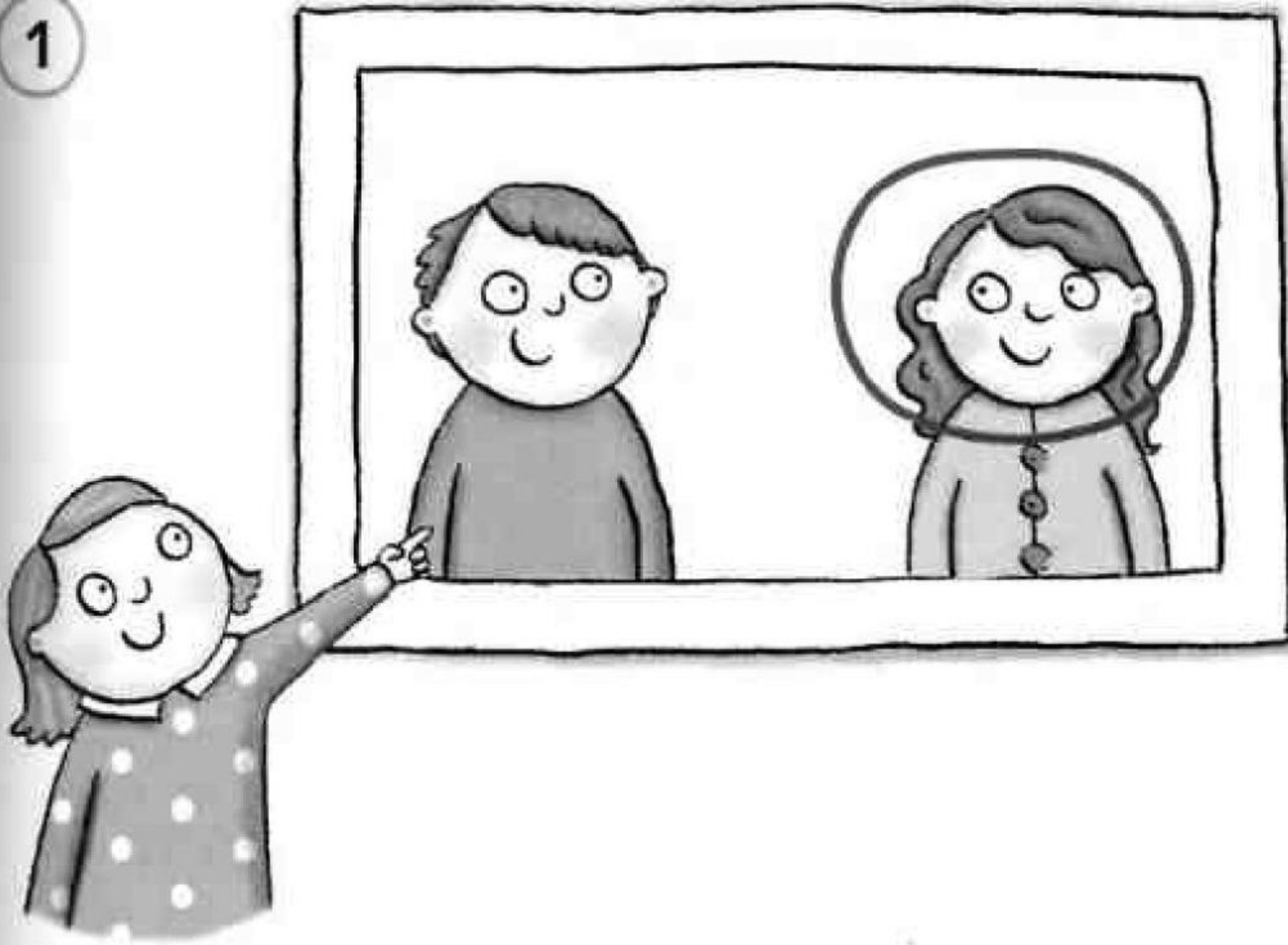

2

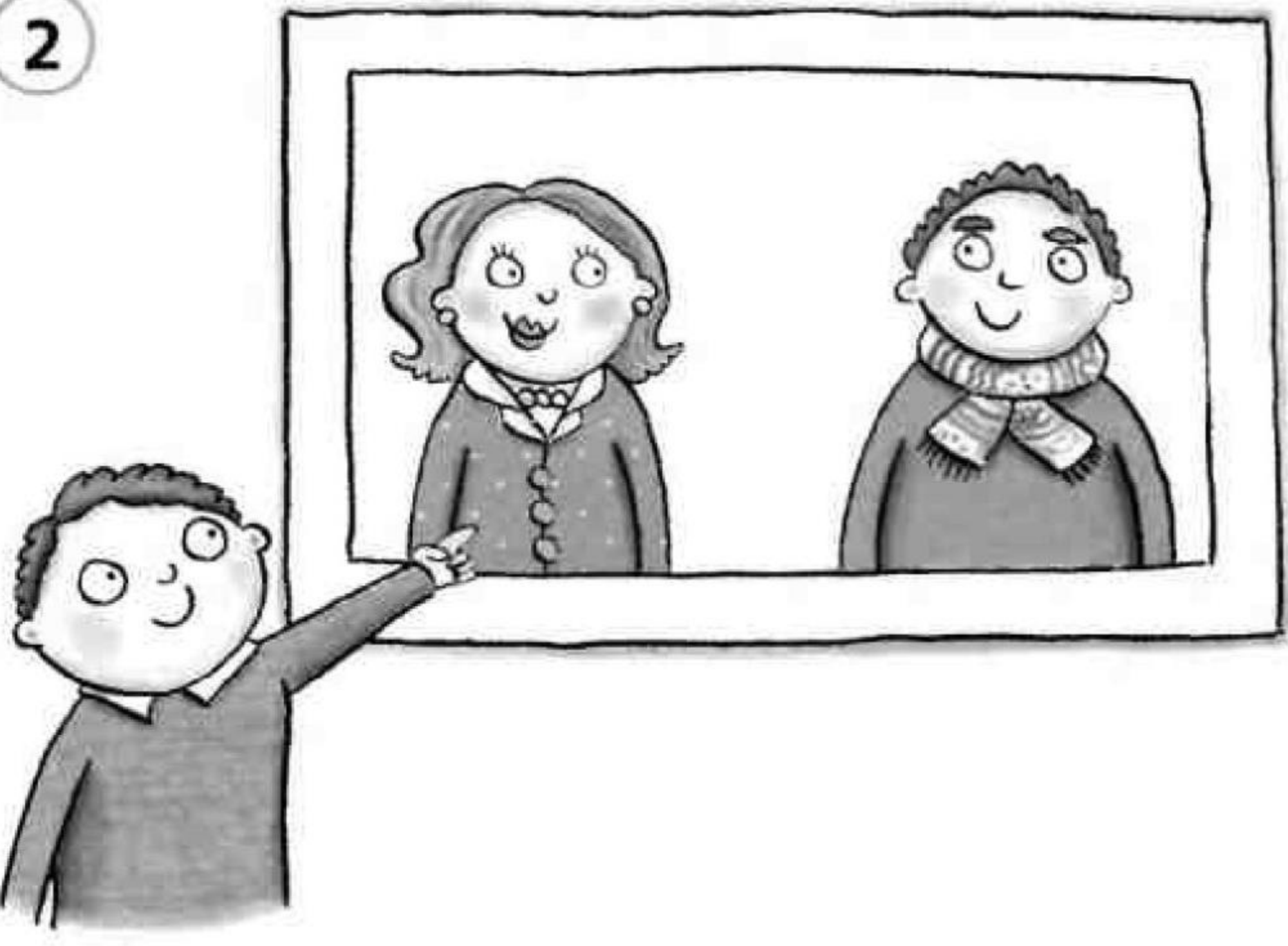

3

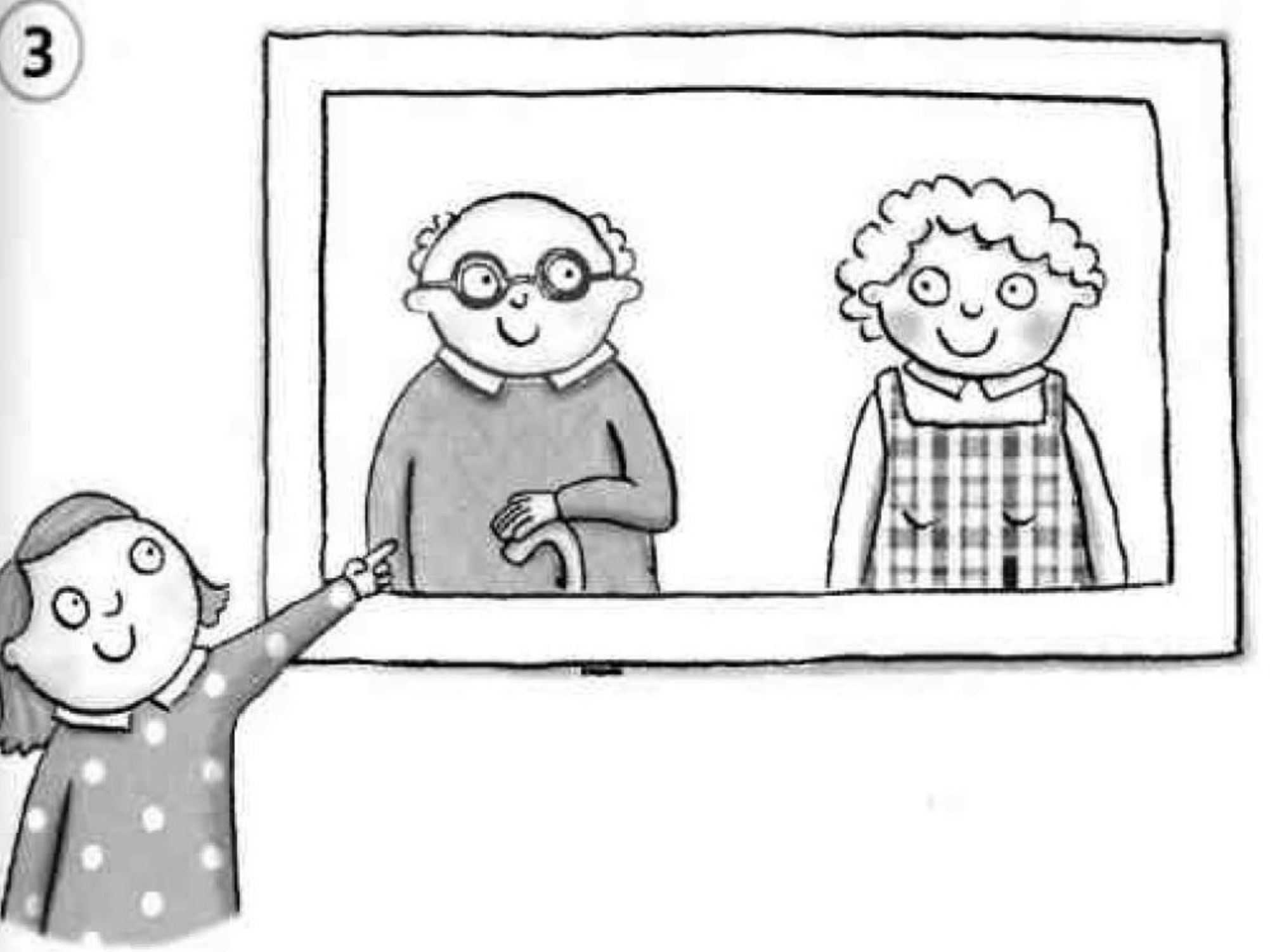

4

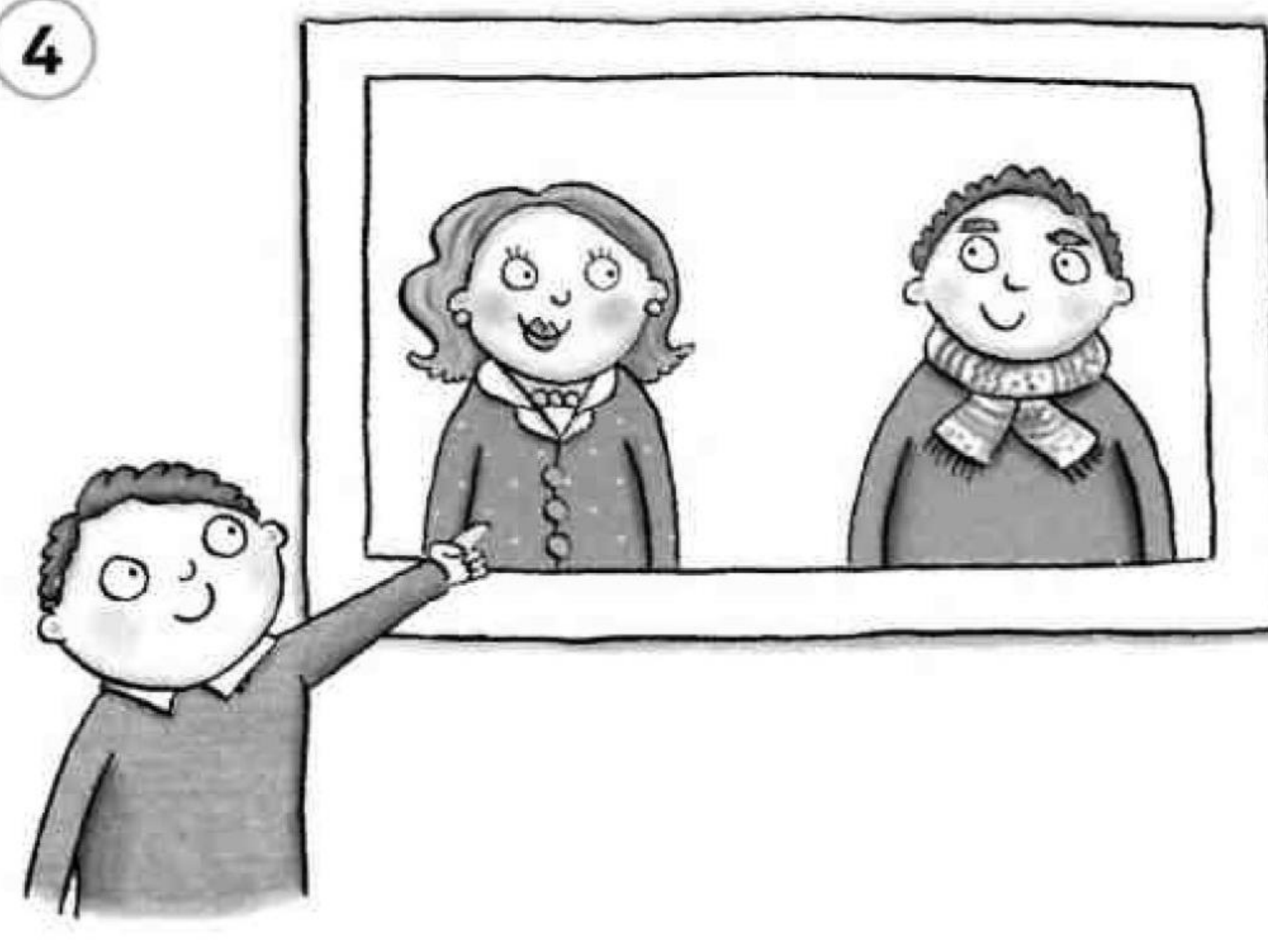

5

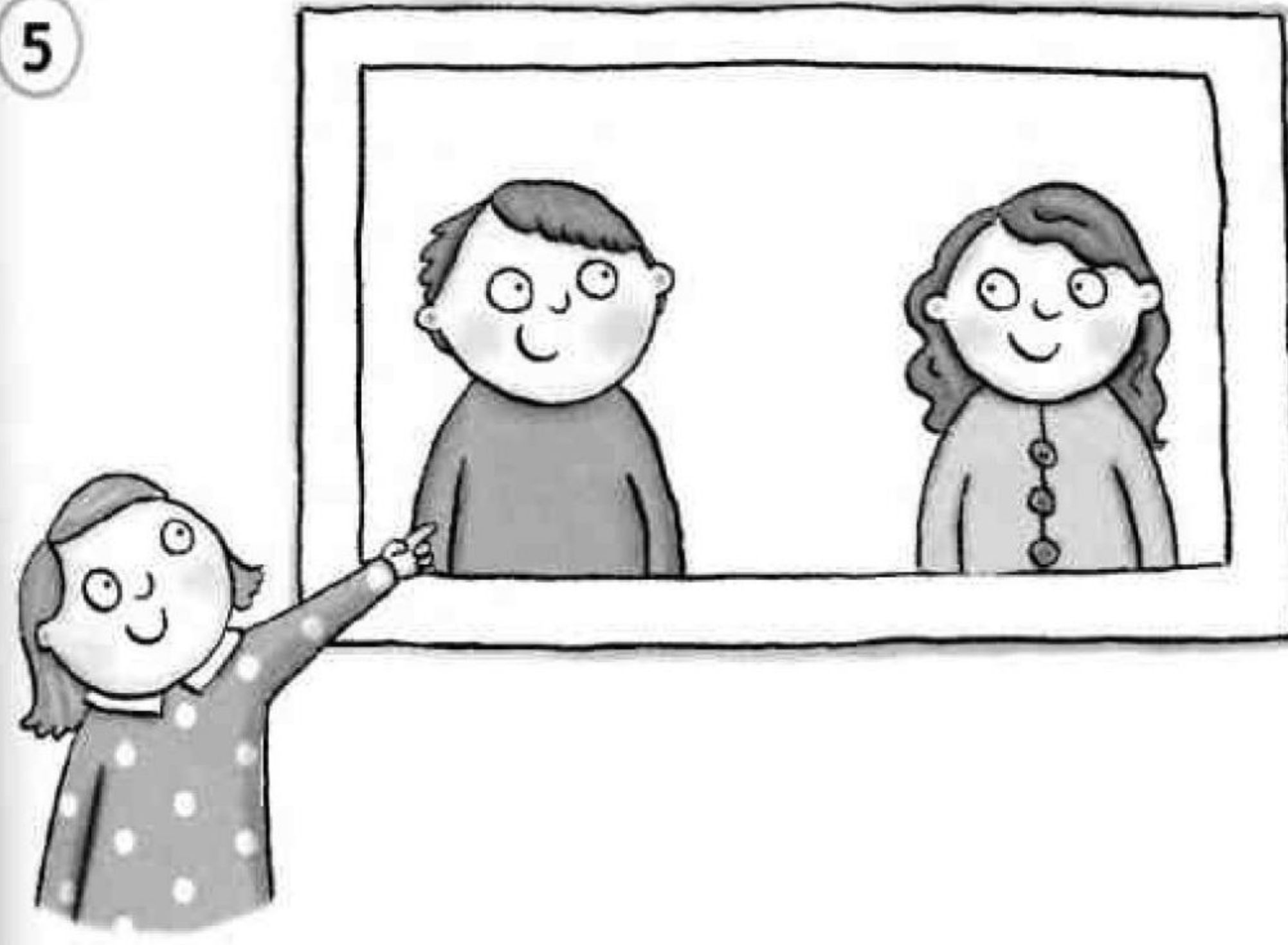

6

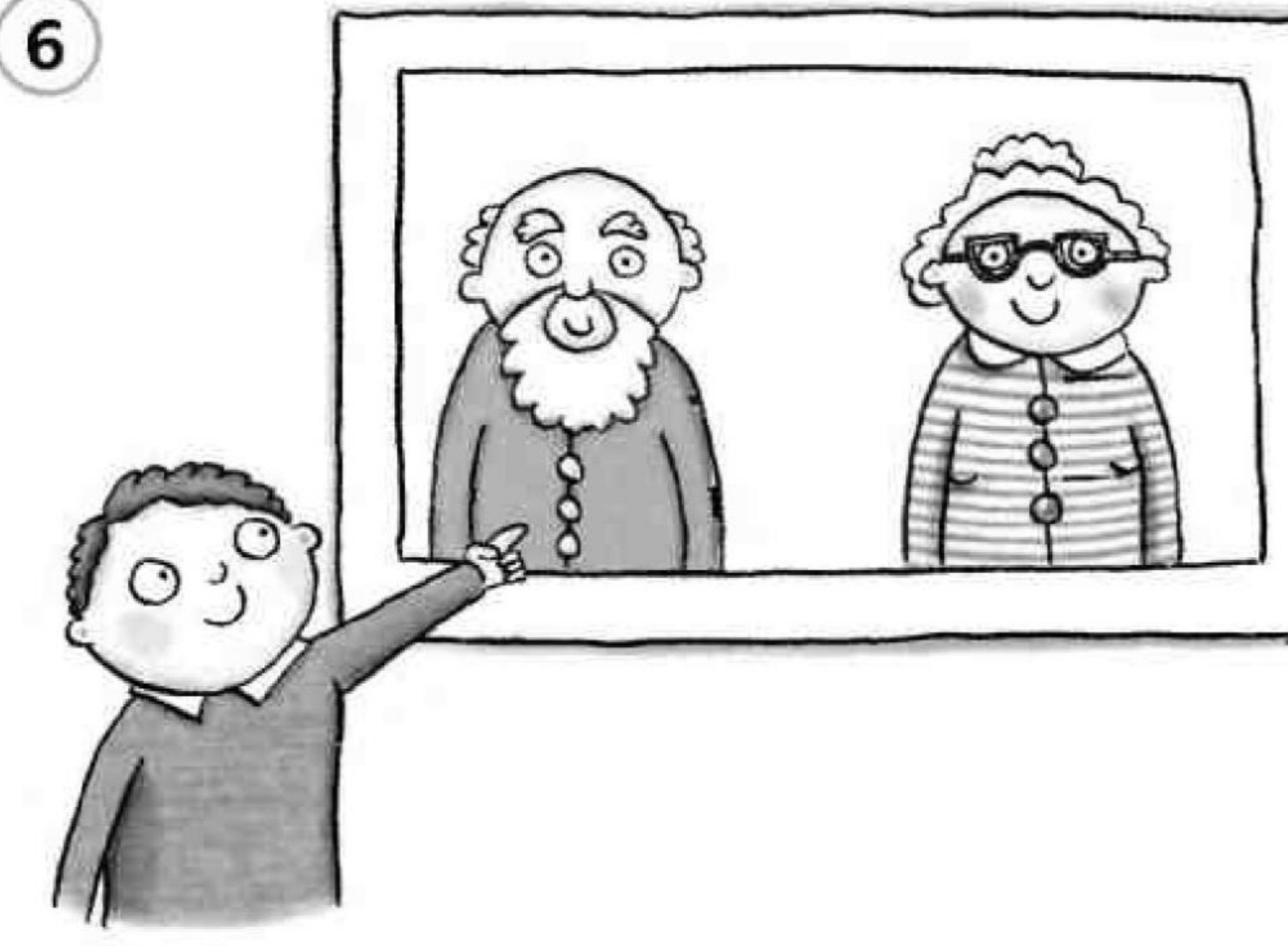

1

Point and say the names and the words.

1



2



3



4



5



6



1 Draw lines. Colour and make sentences.

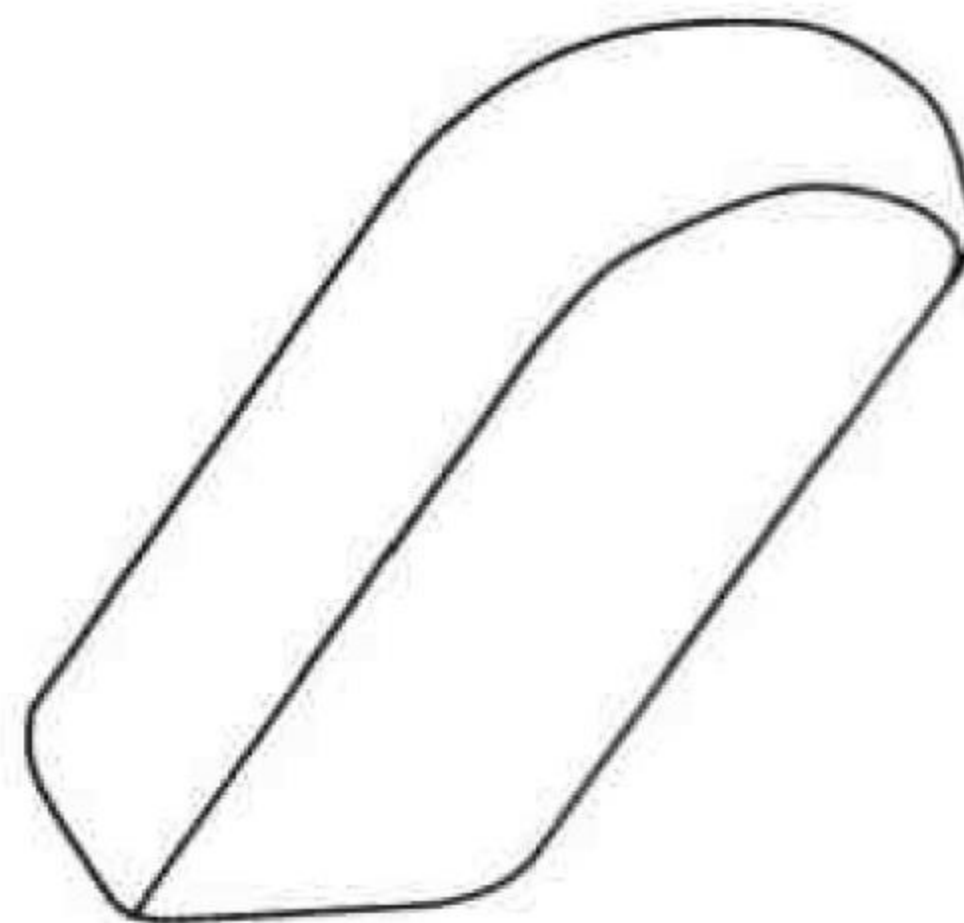
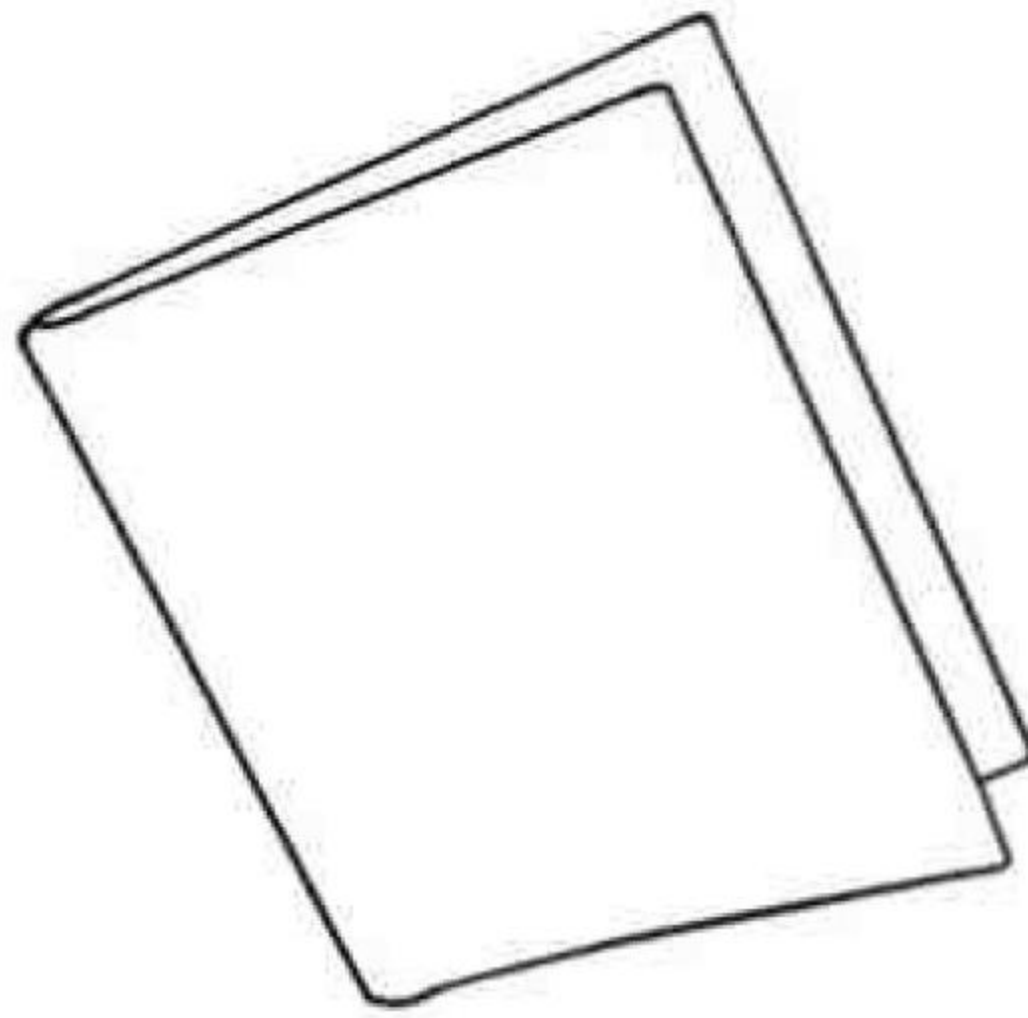

Listen and trace.

1



2

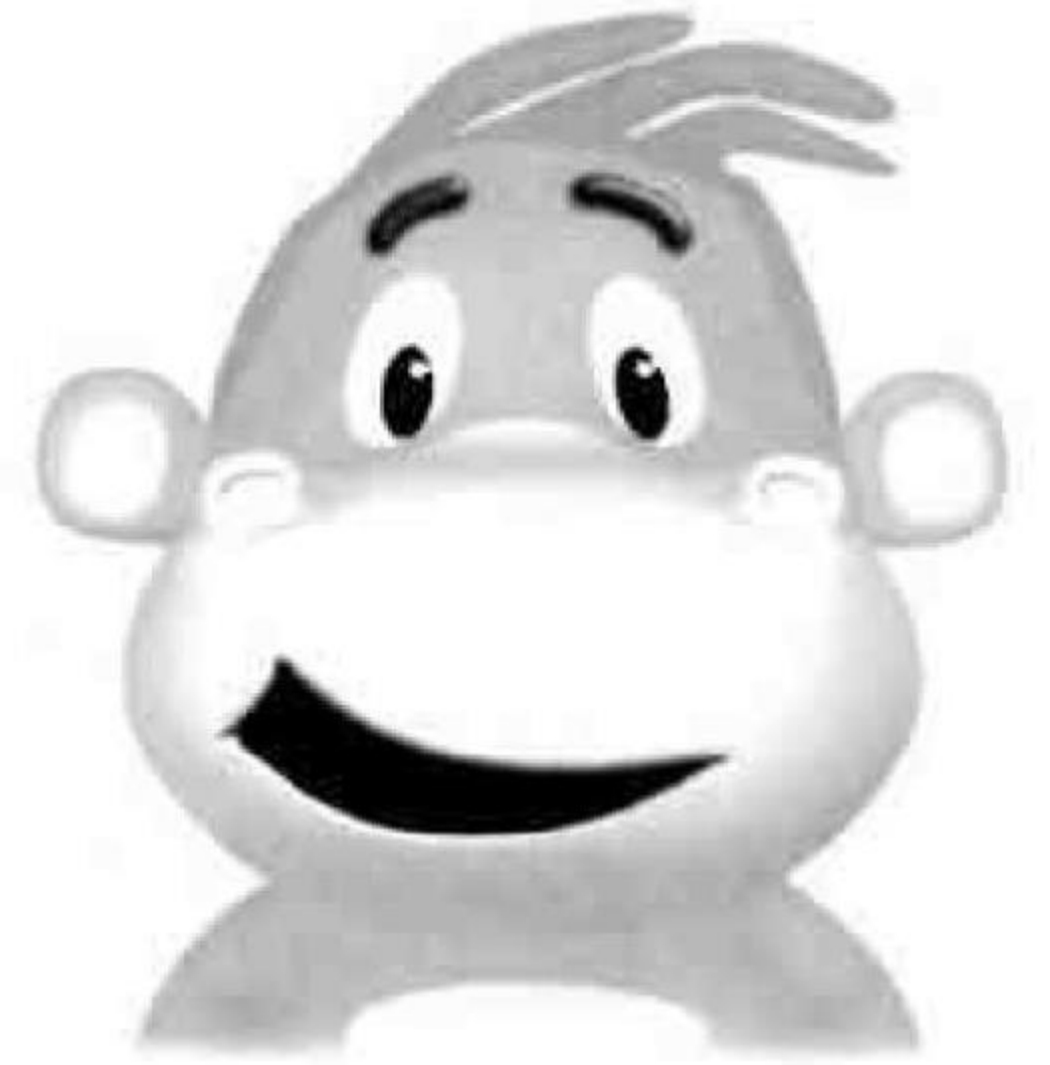
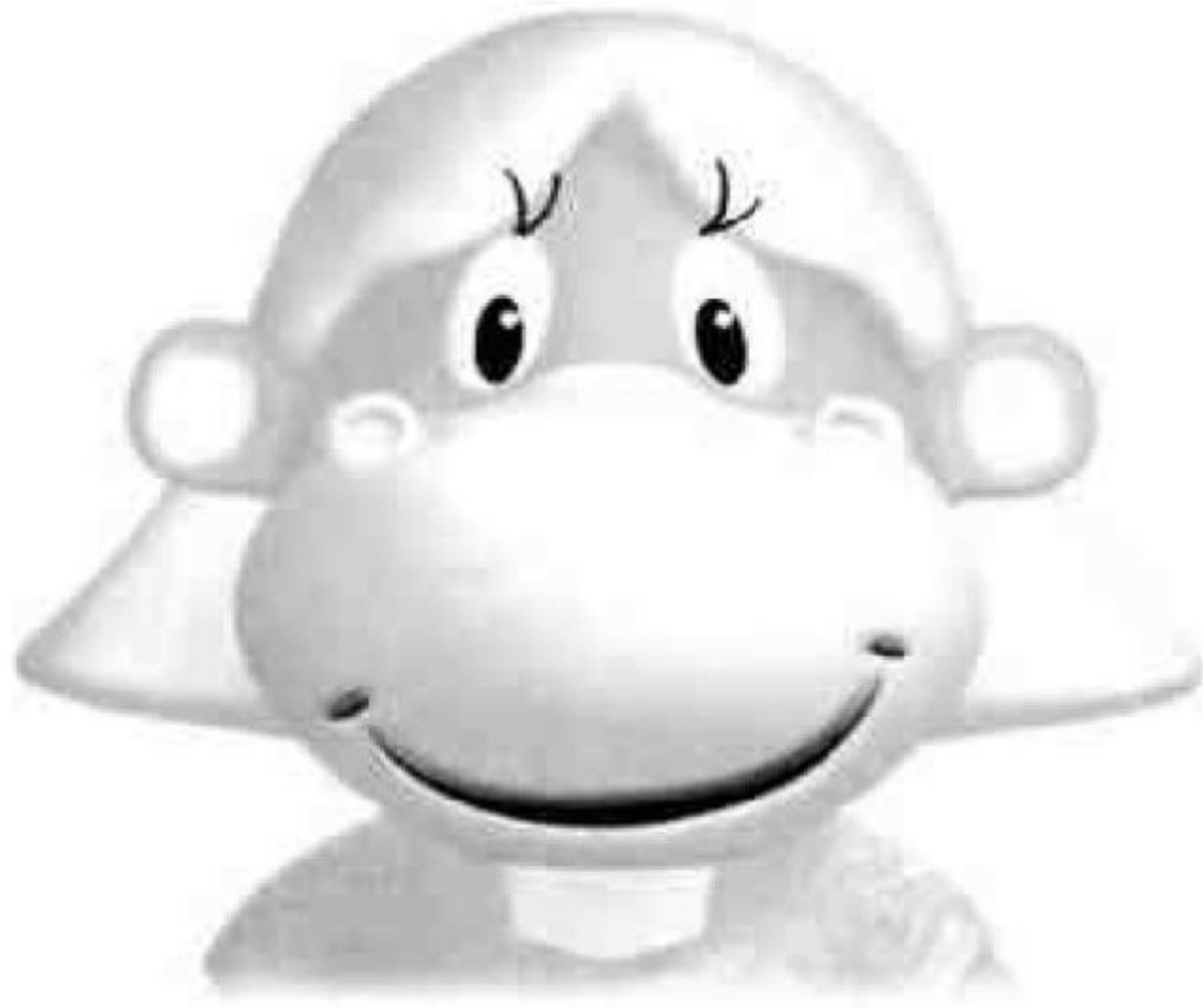

3

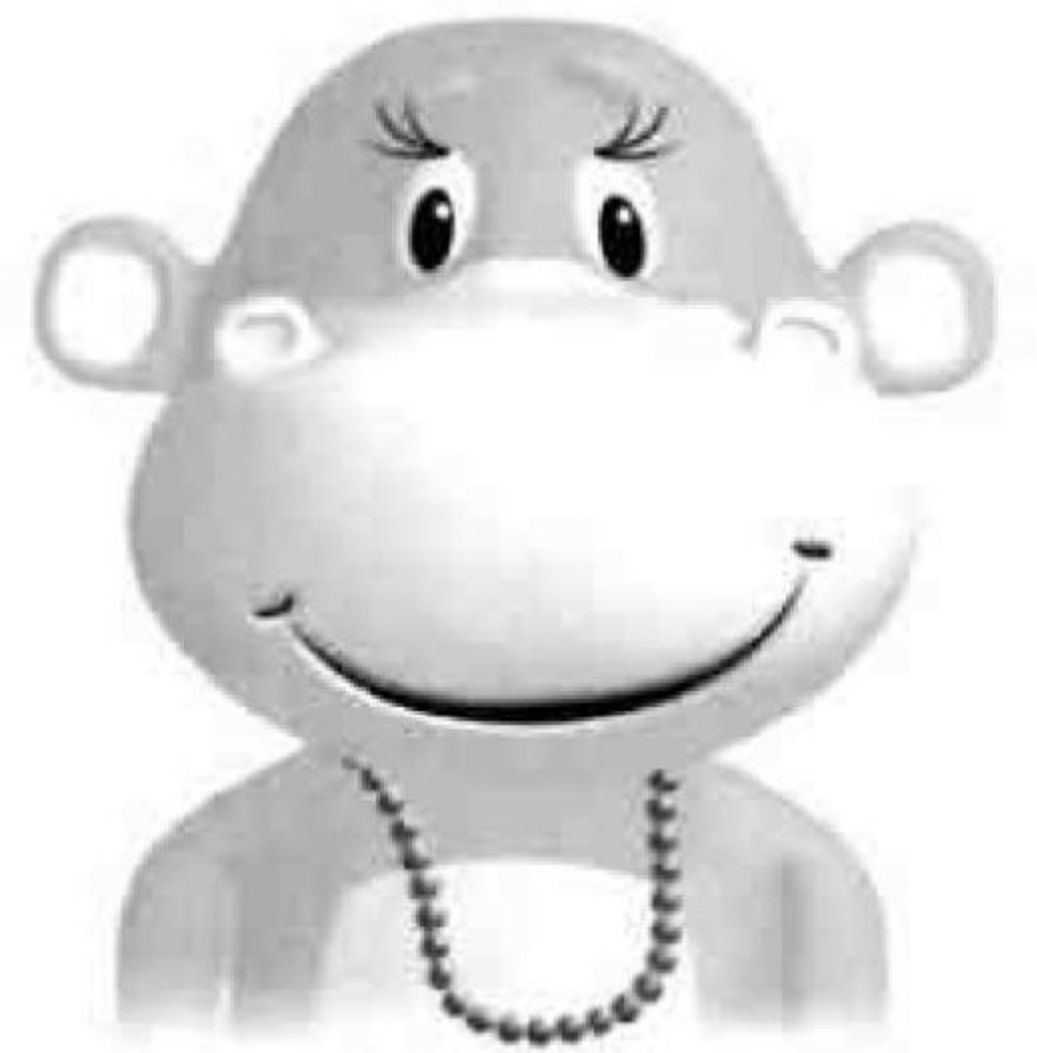

4

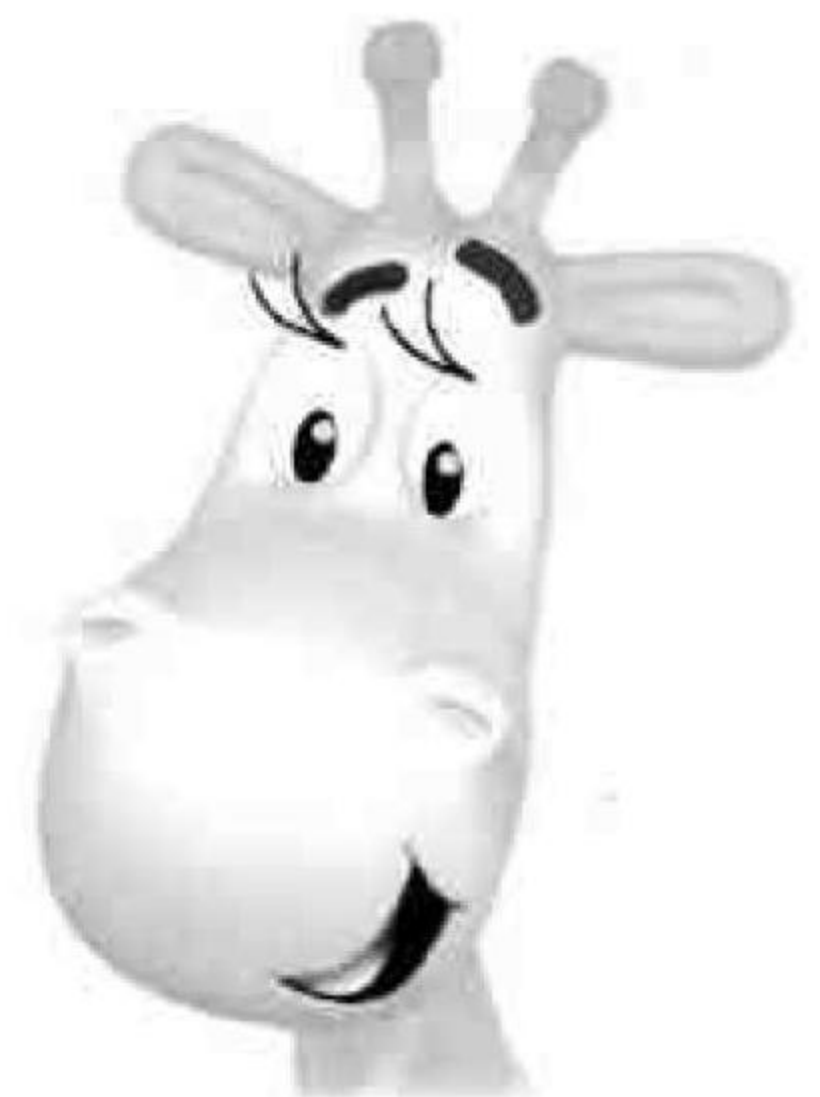

1 Think! Look and colour.

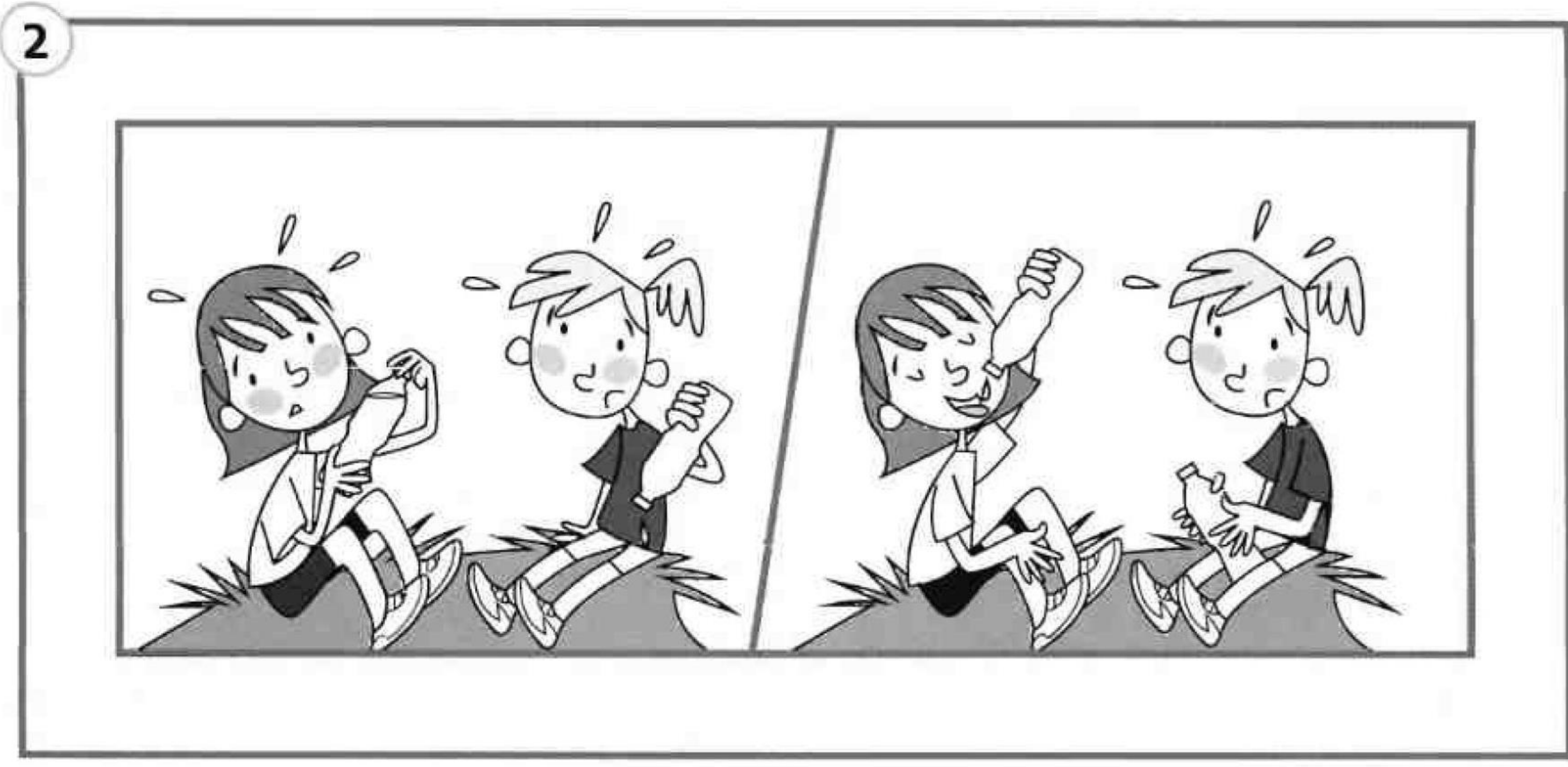
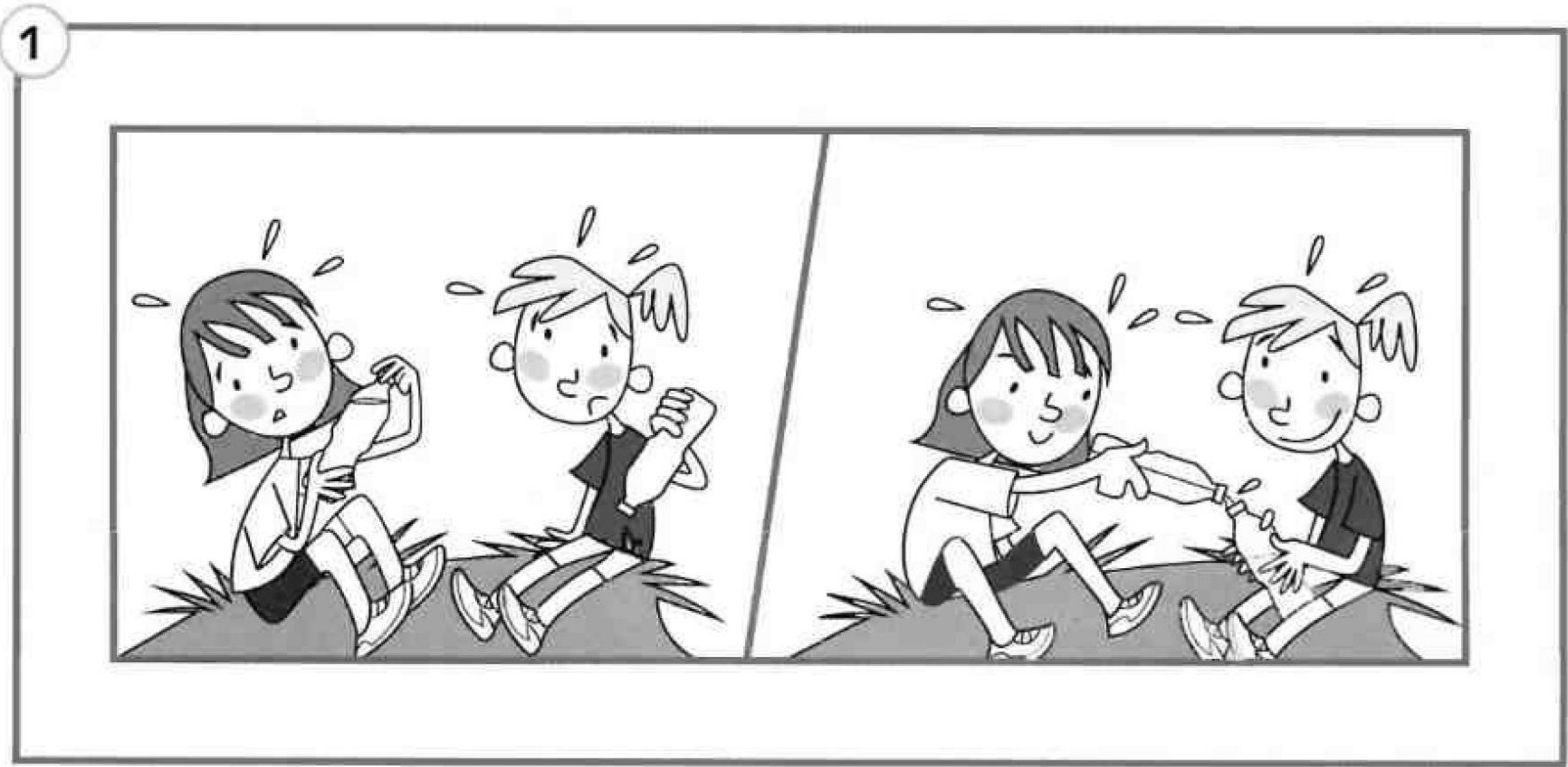

1

Look and draw.

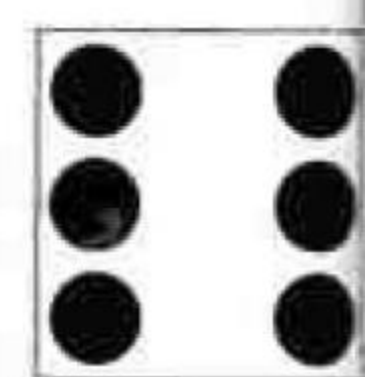
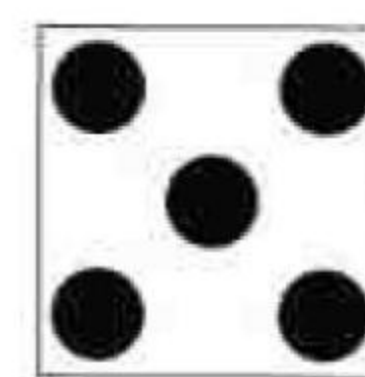
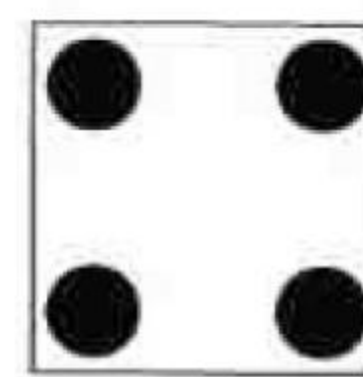
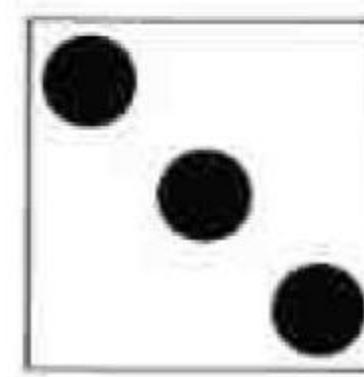
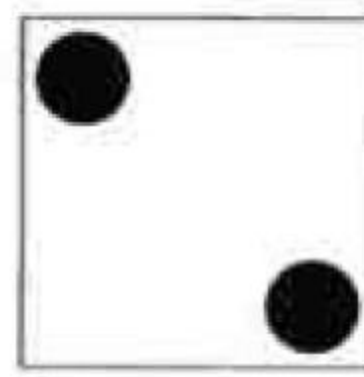
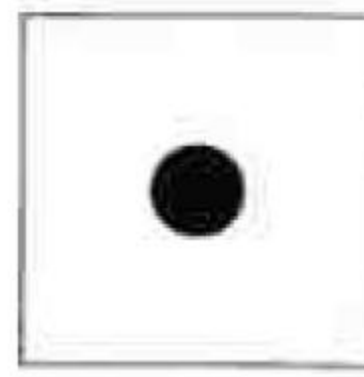

1

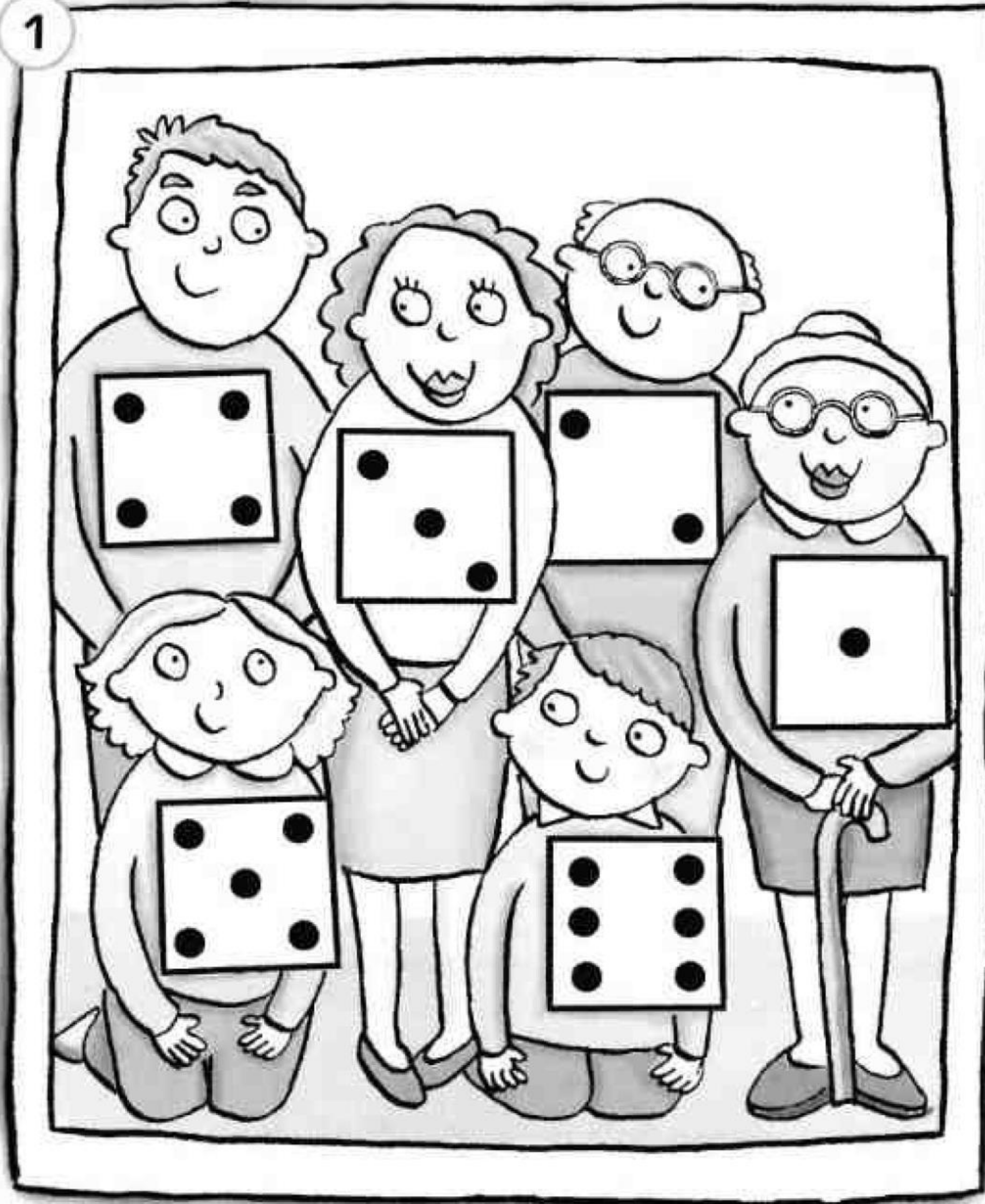

2

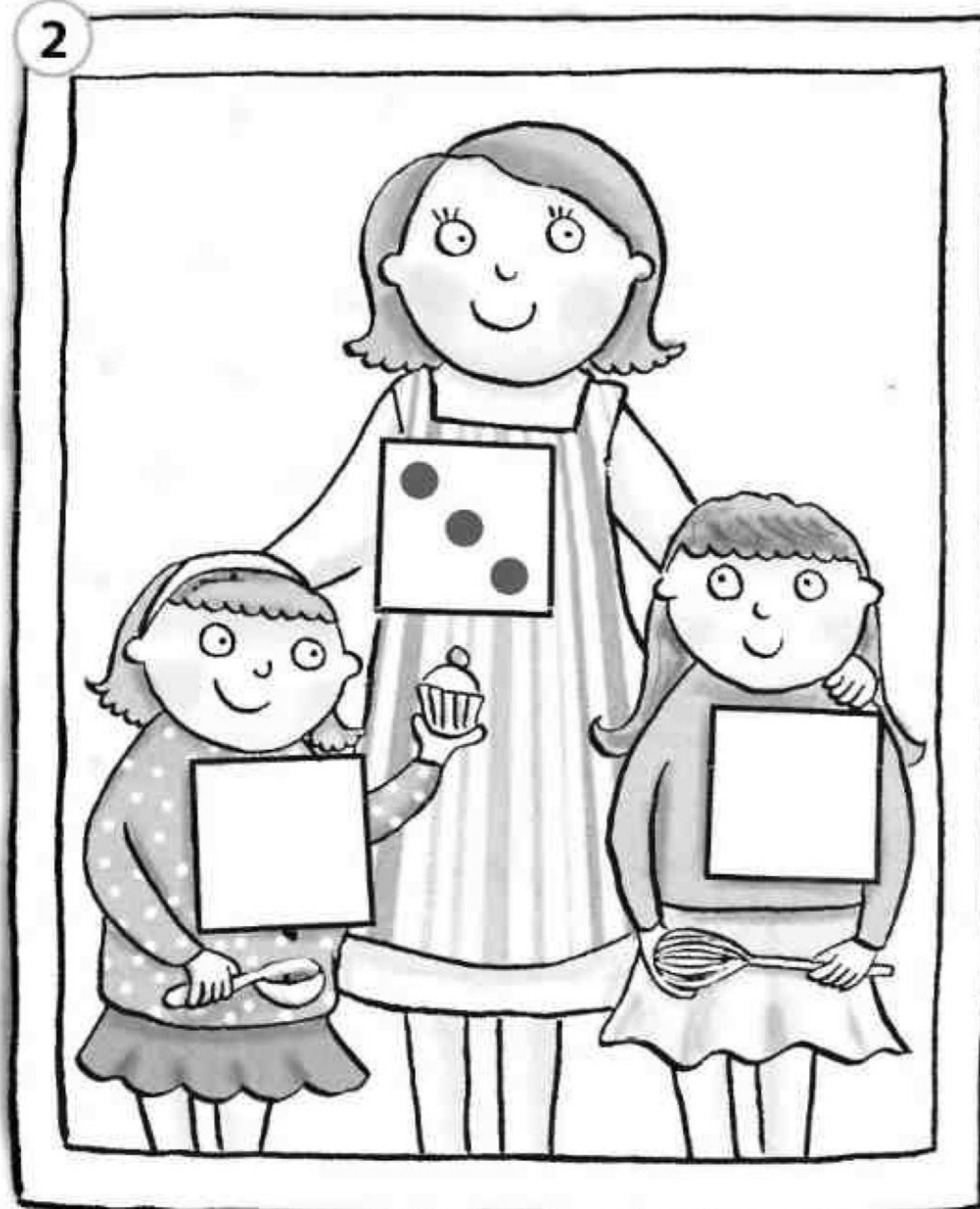

3

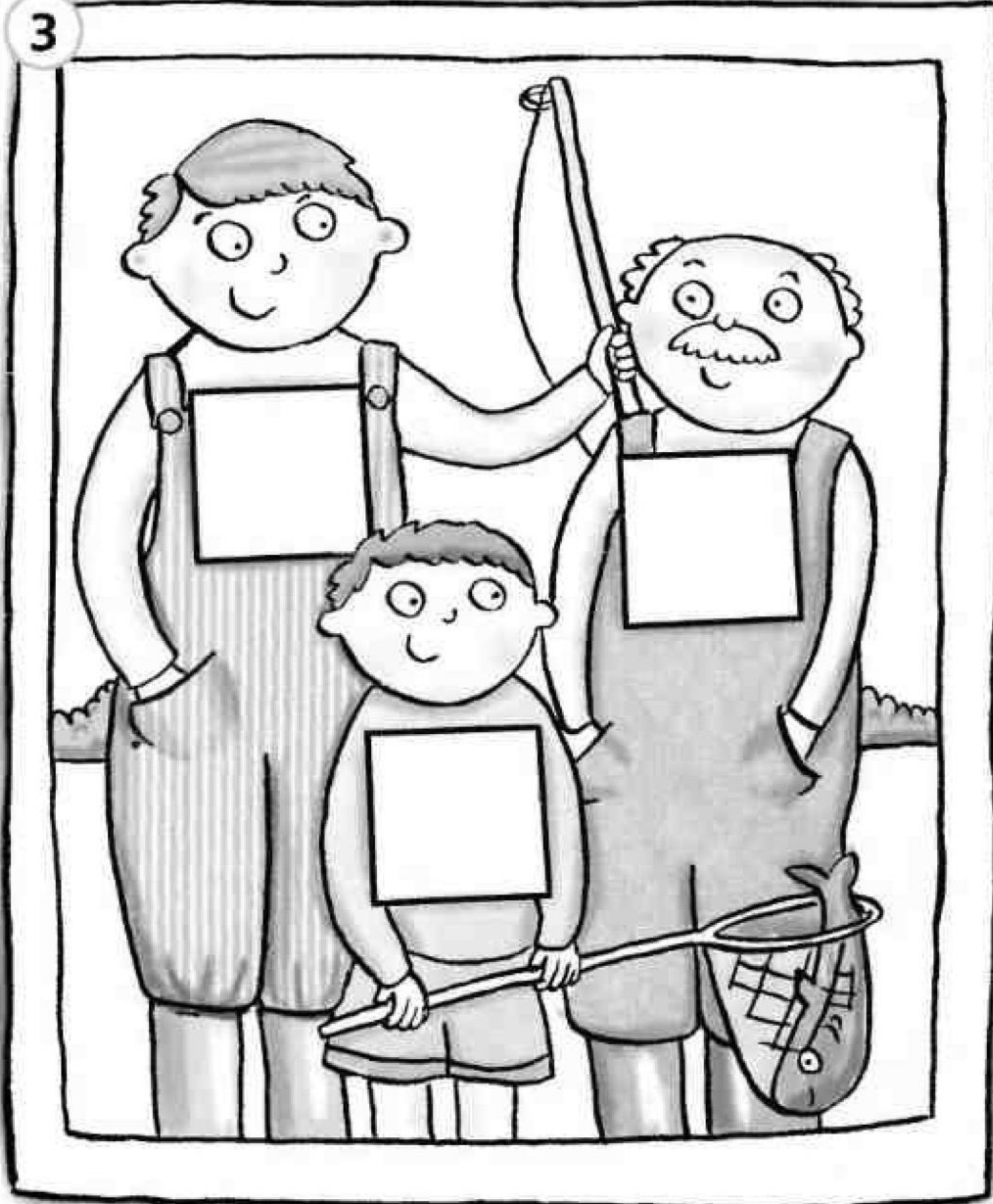

4



1 Think! Look and say the family words.

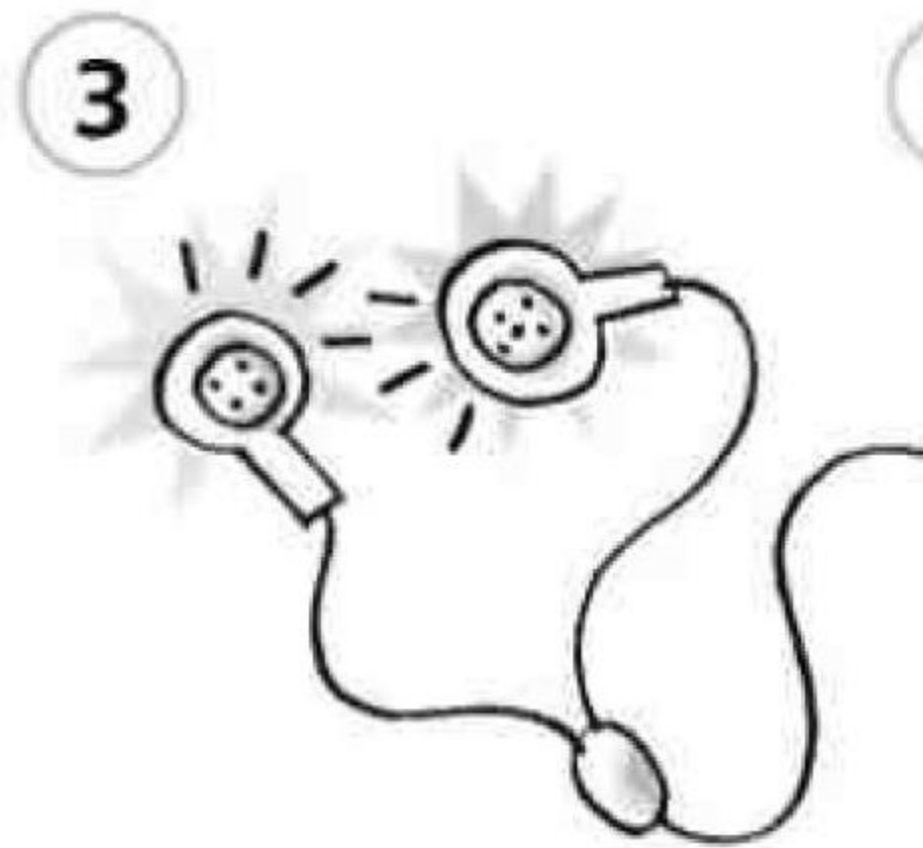
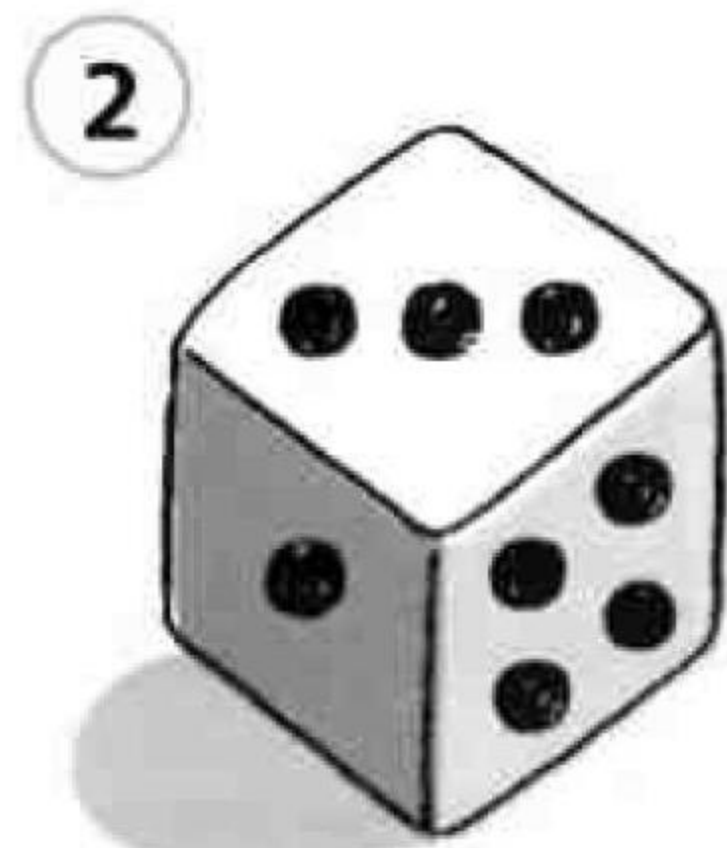
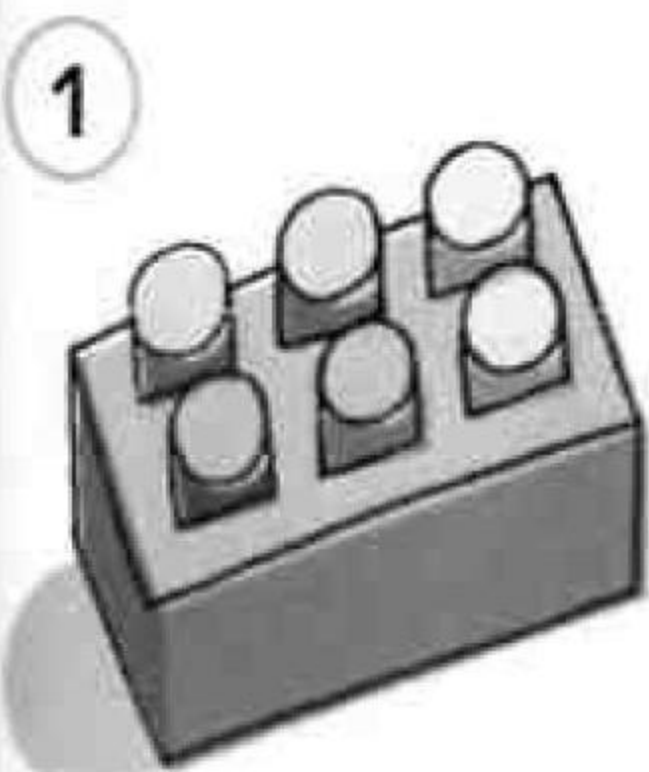

1

Make an ice lolly stick family.

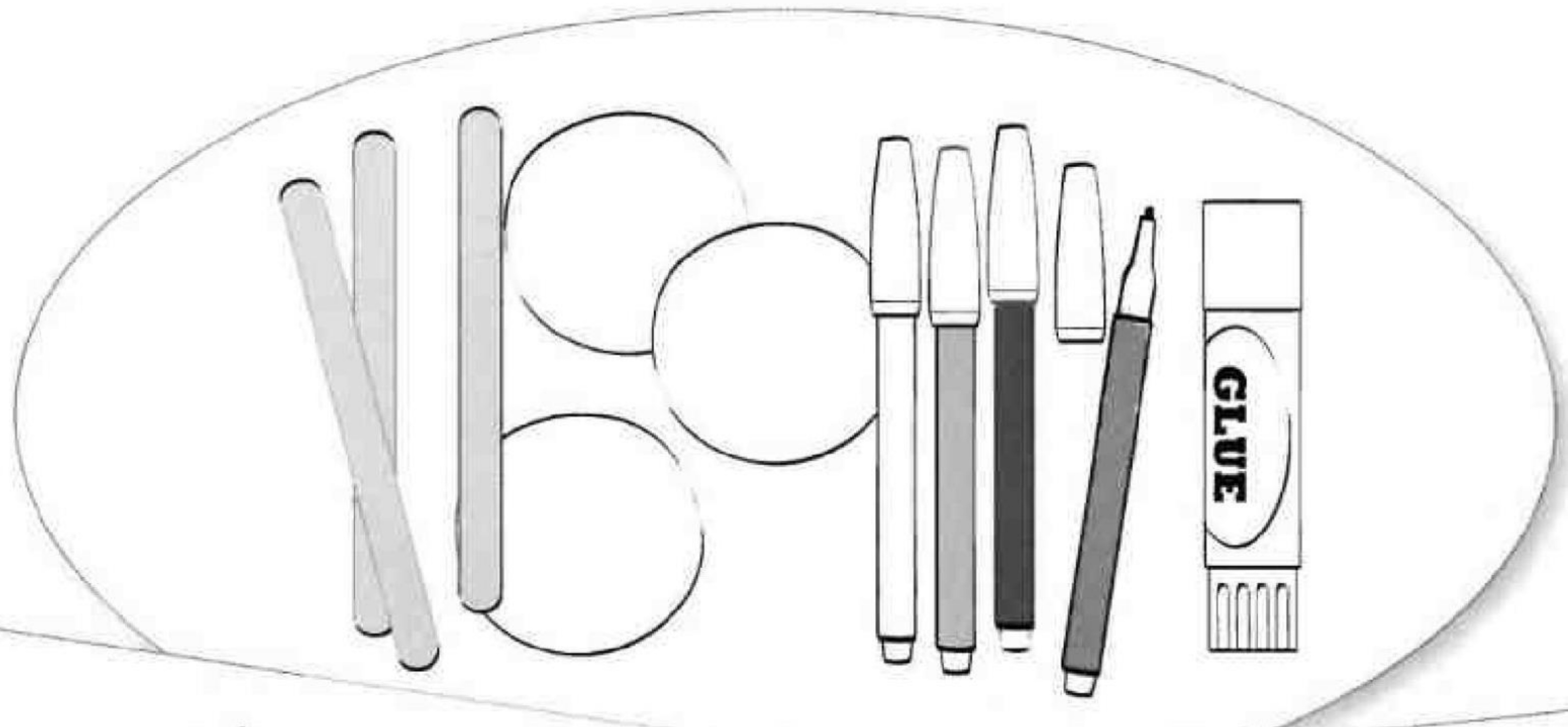

1



2



1 Say the words. Colour the circles.

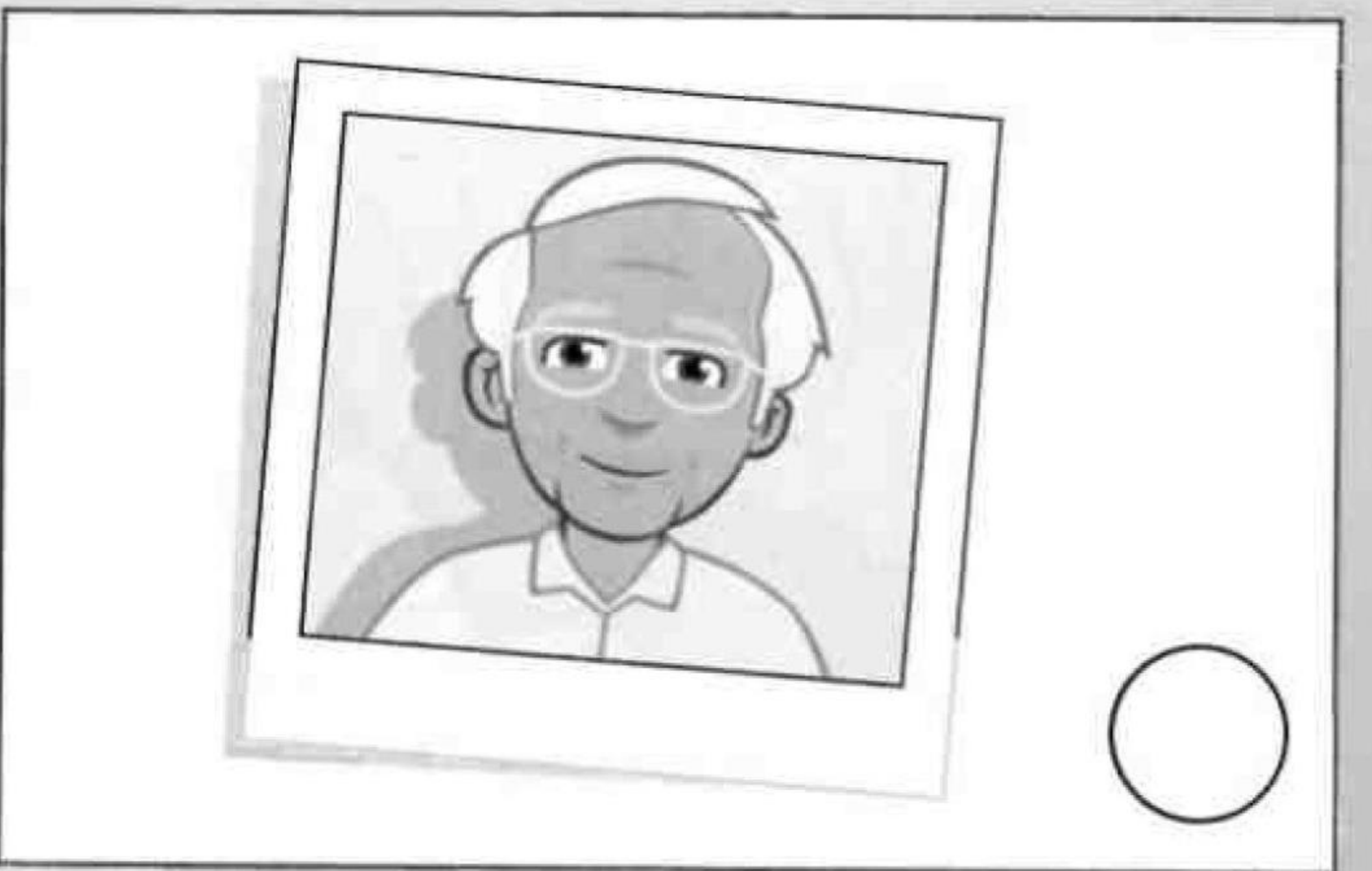
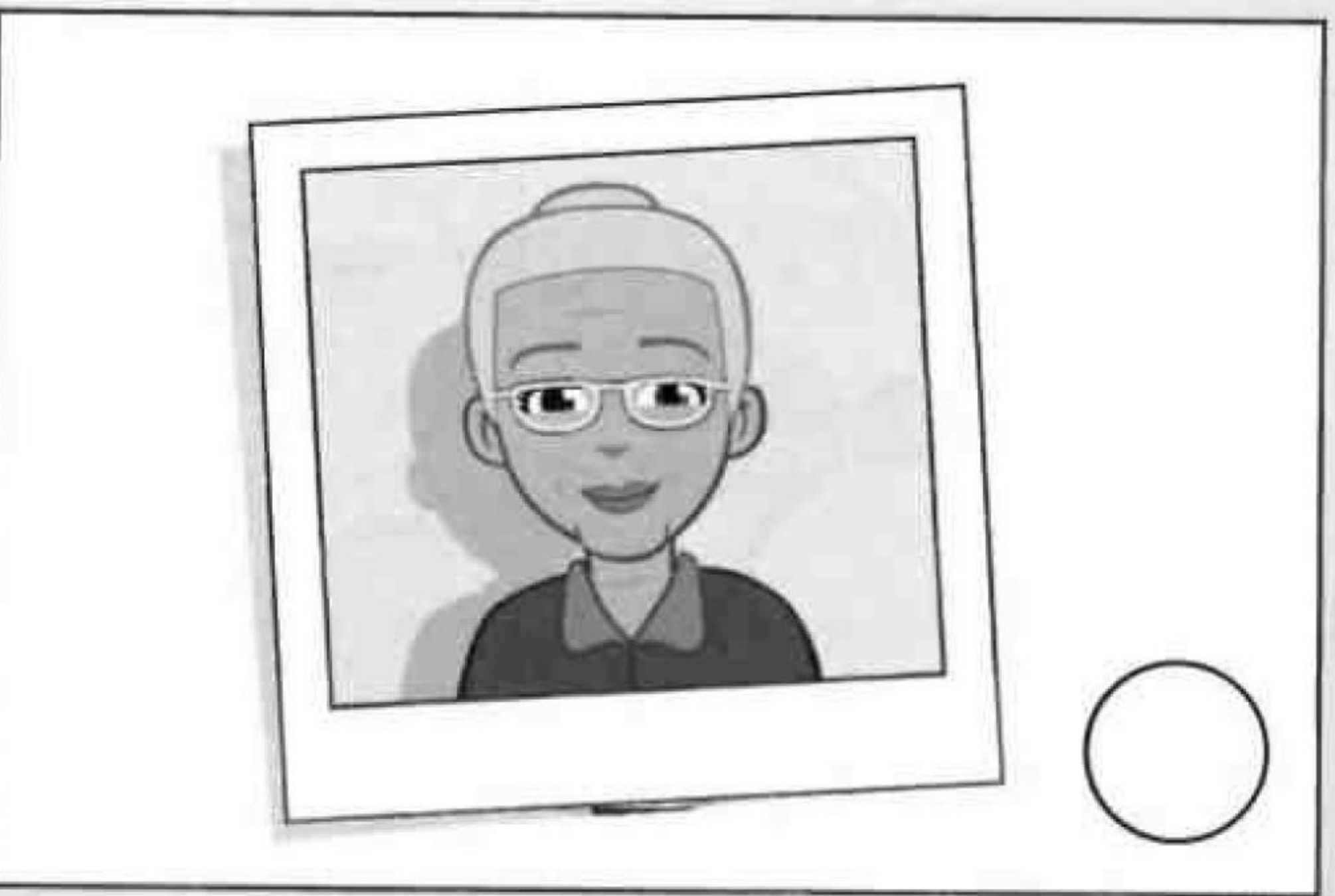
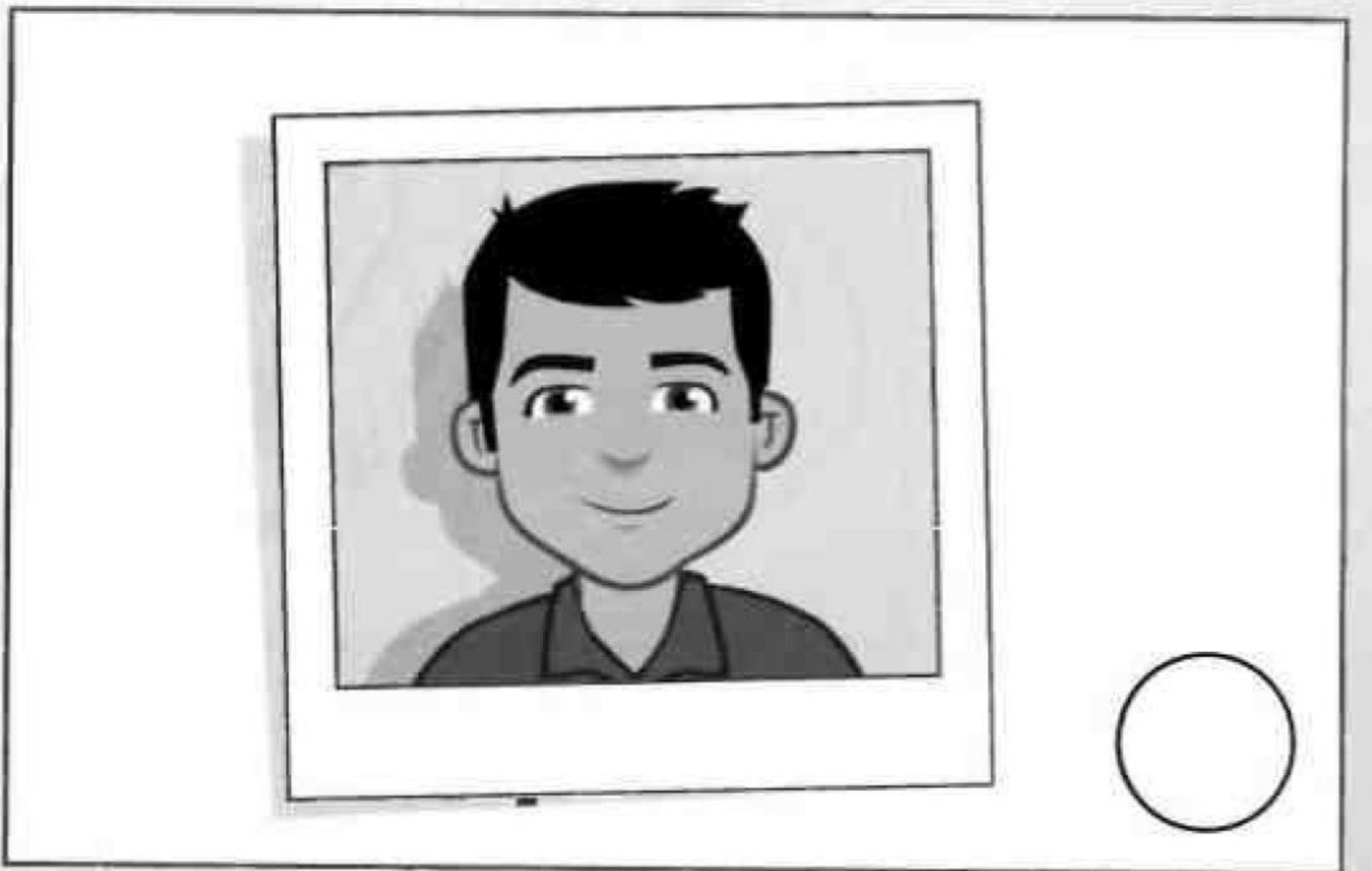
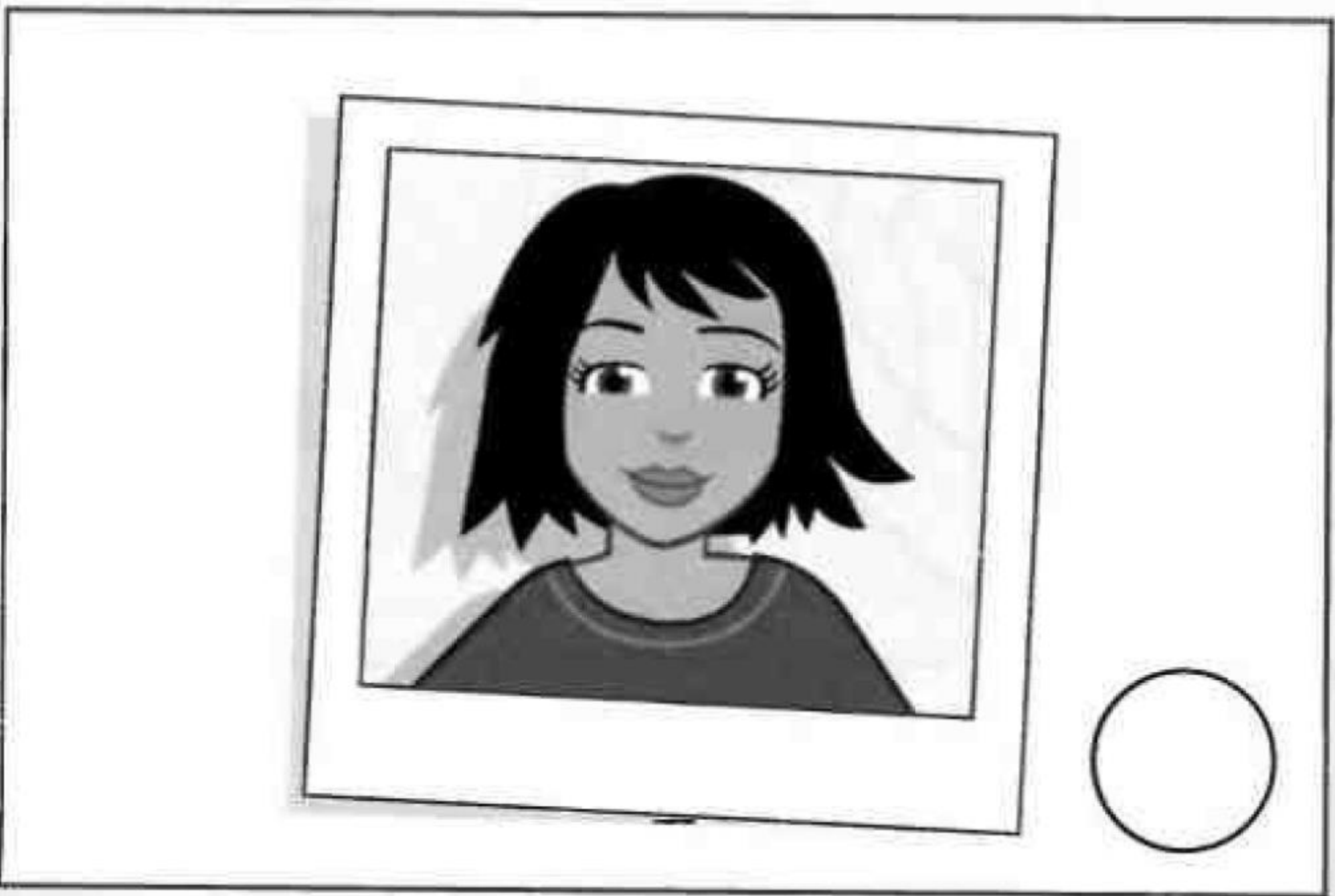
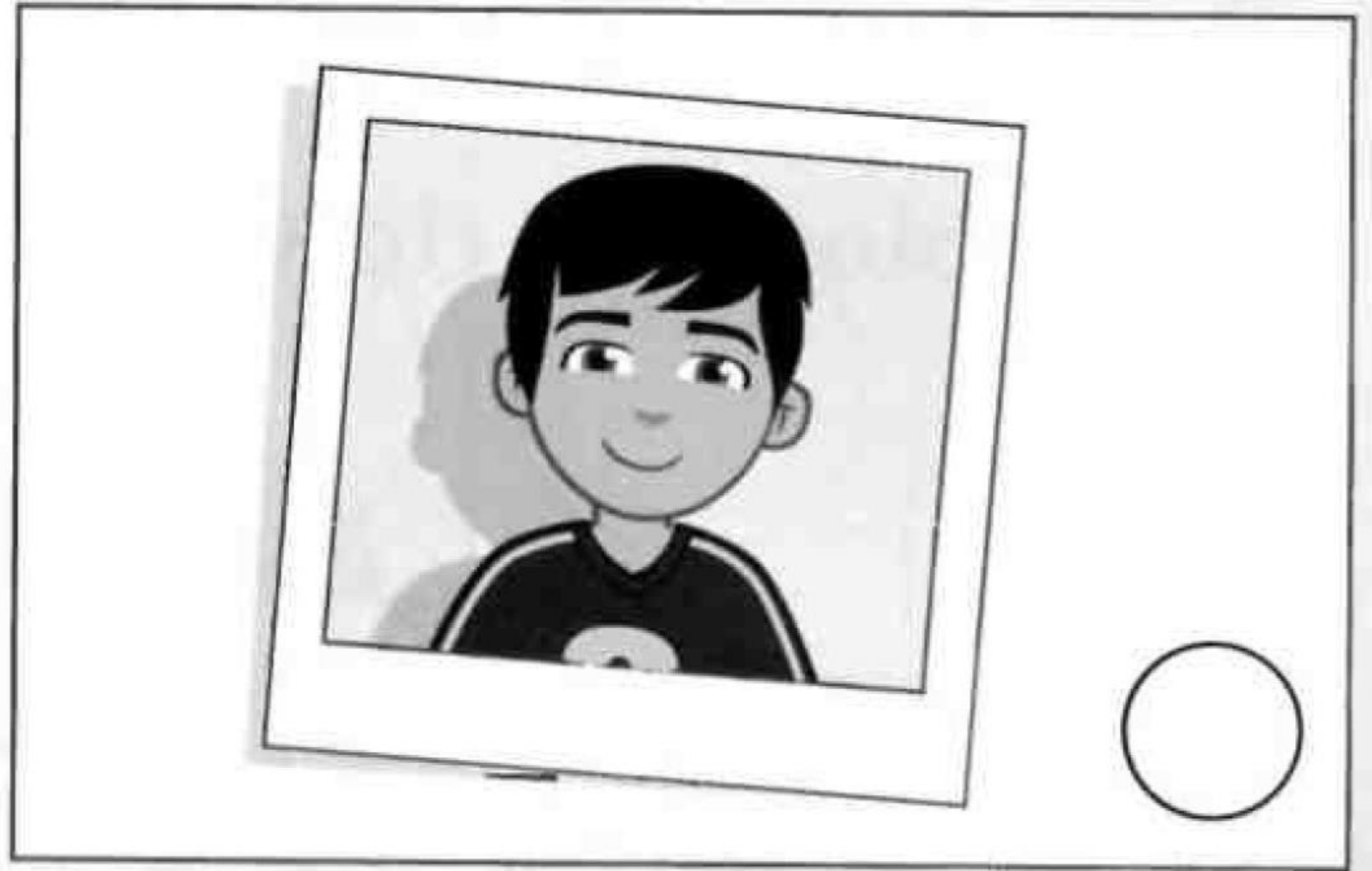
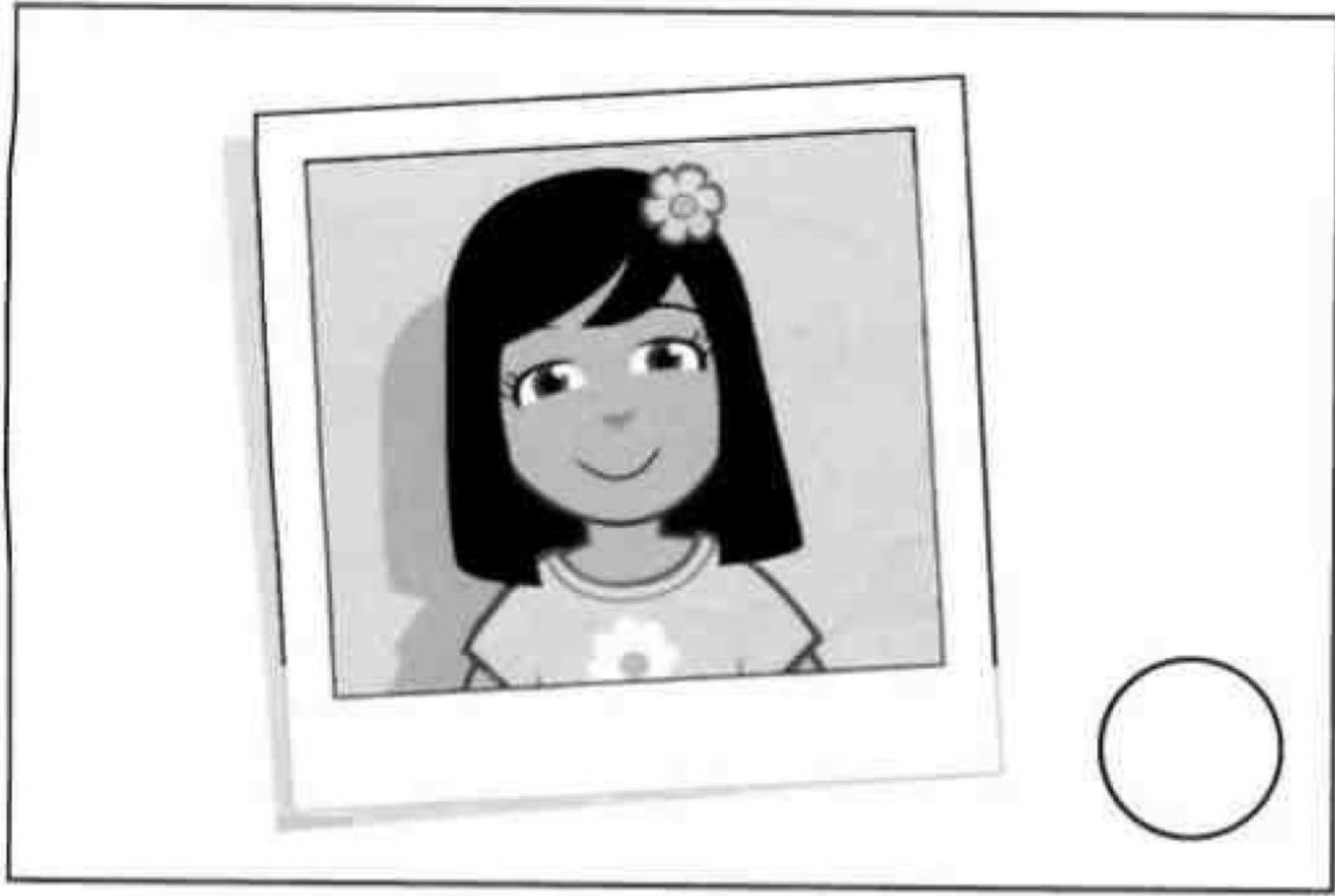

2 Draw faces. 😊 😐 😞

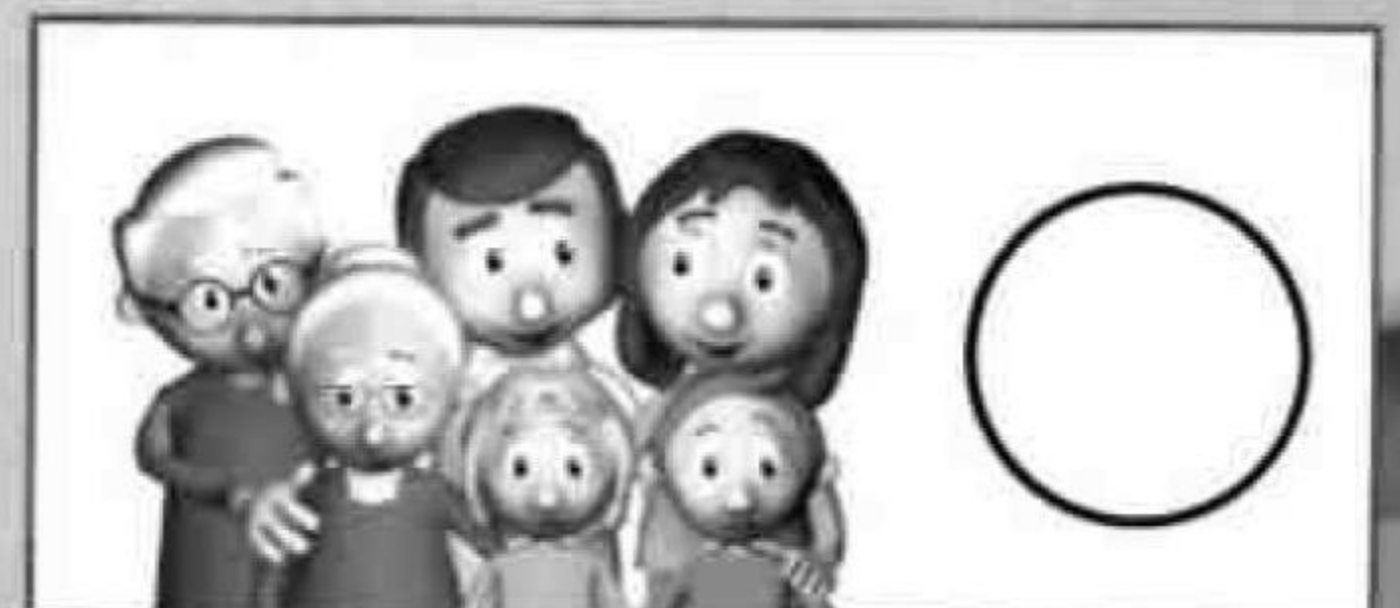
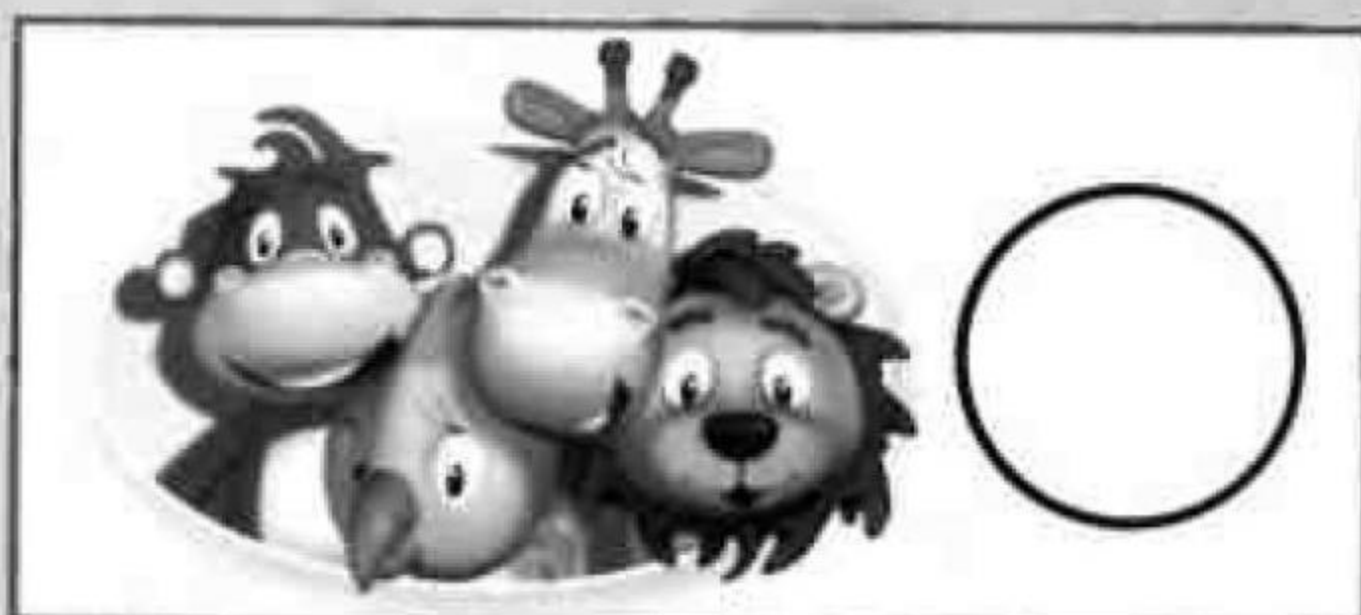
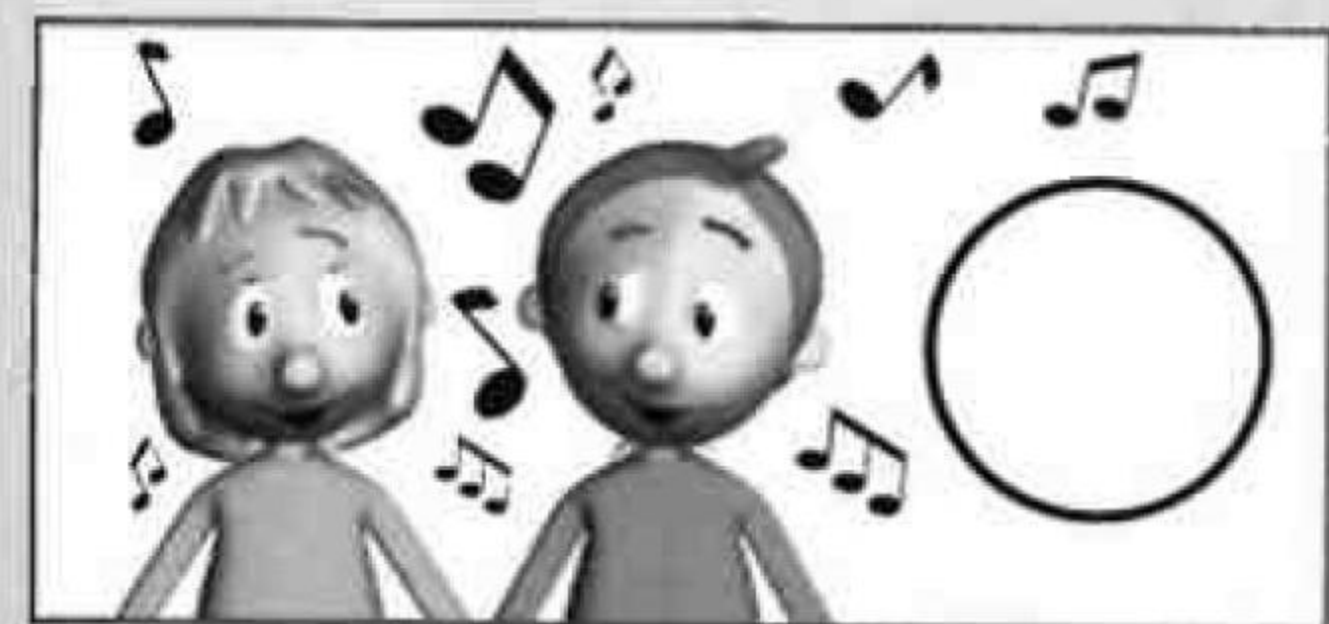

1 Colour the clown.



2 Describe your clown. Colour your friend's clown.



1 Think! Look, draw and say the words.

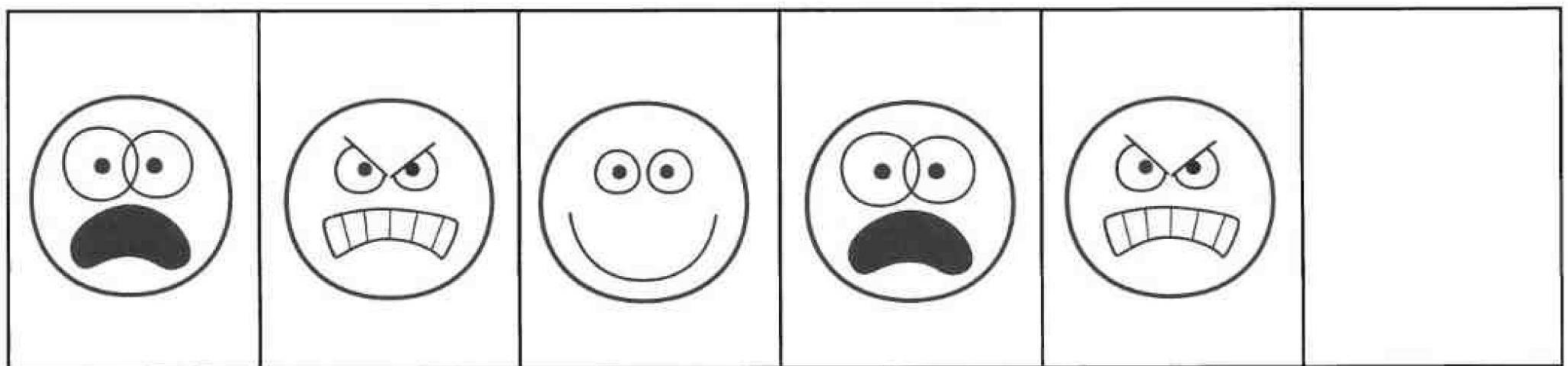
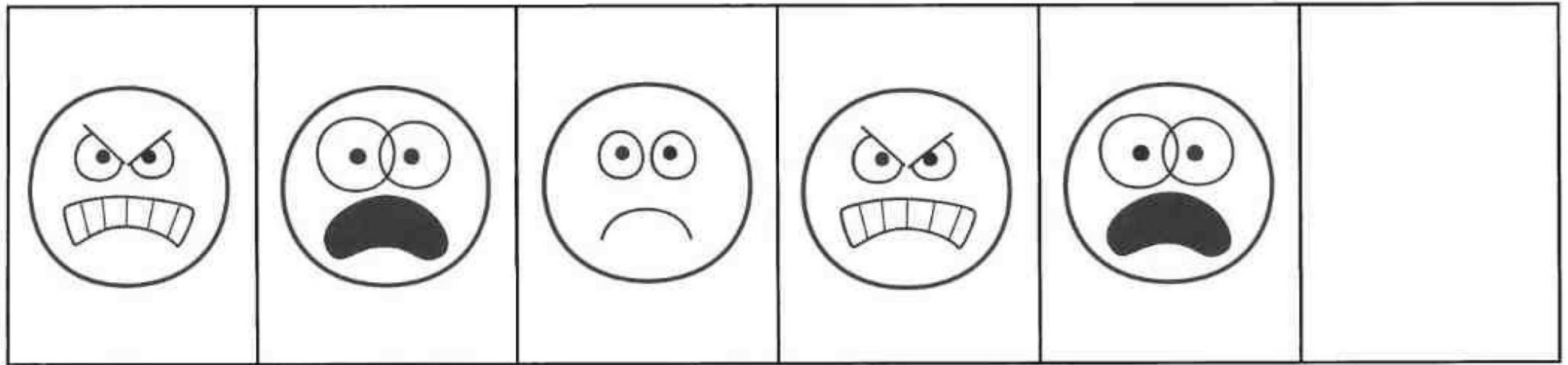
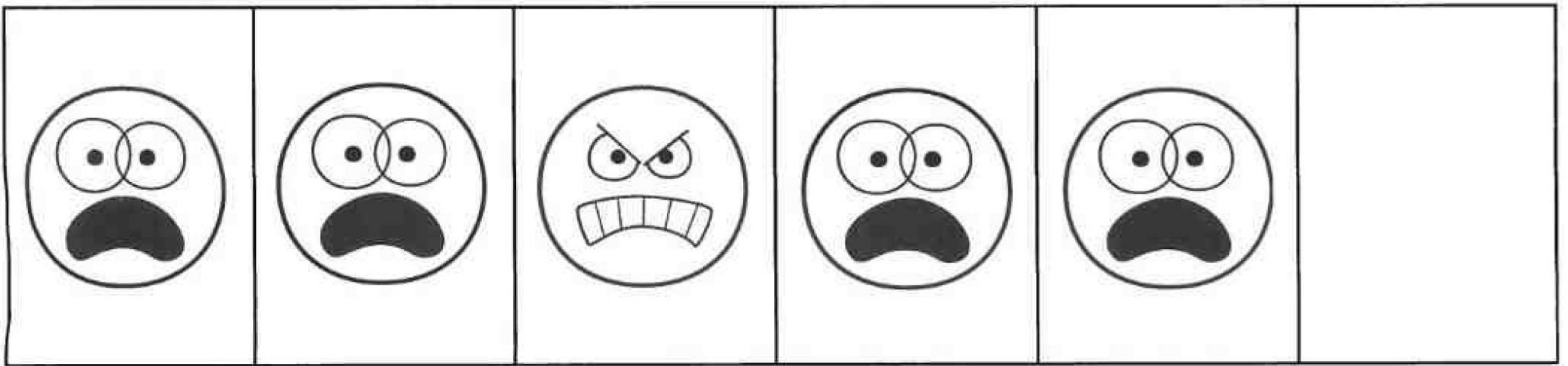
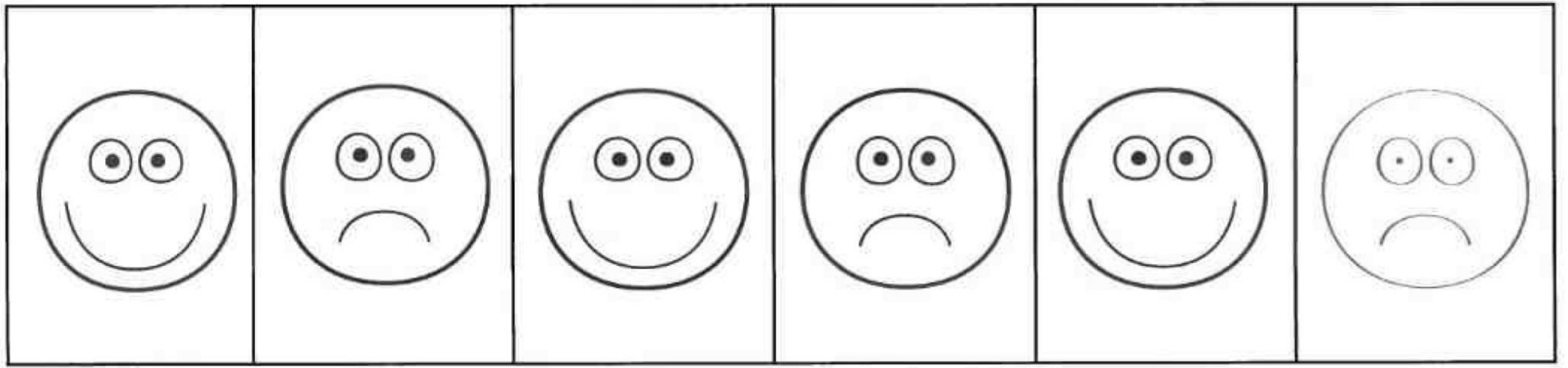

1 How are you feeling today? Complete the face.

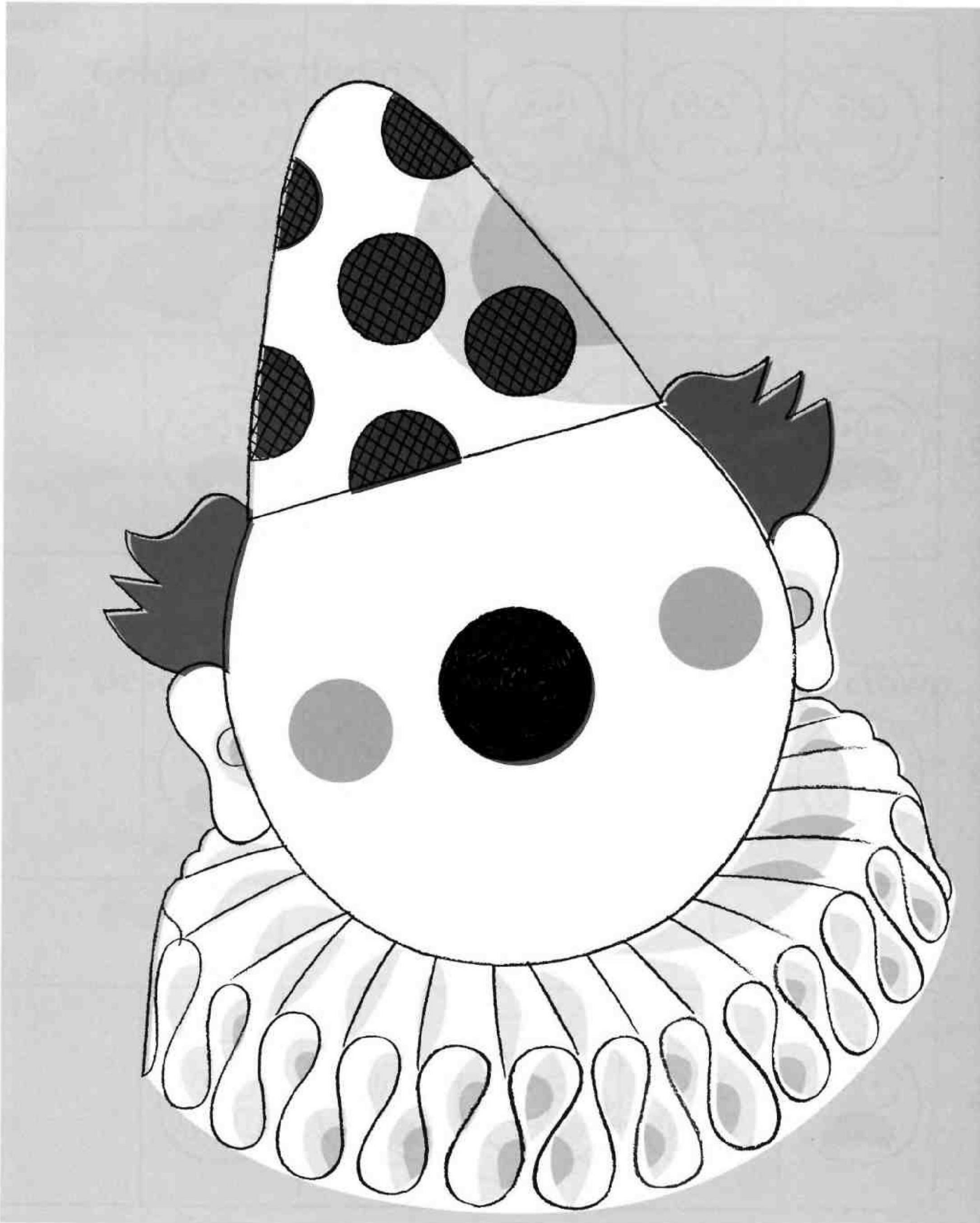

Listen and circle.

1

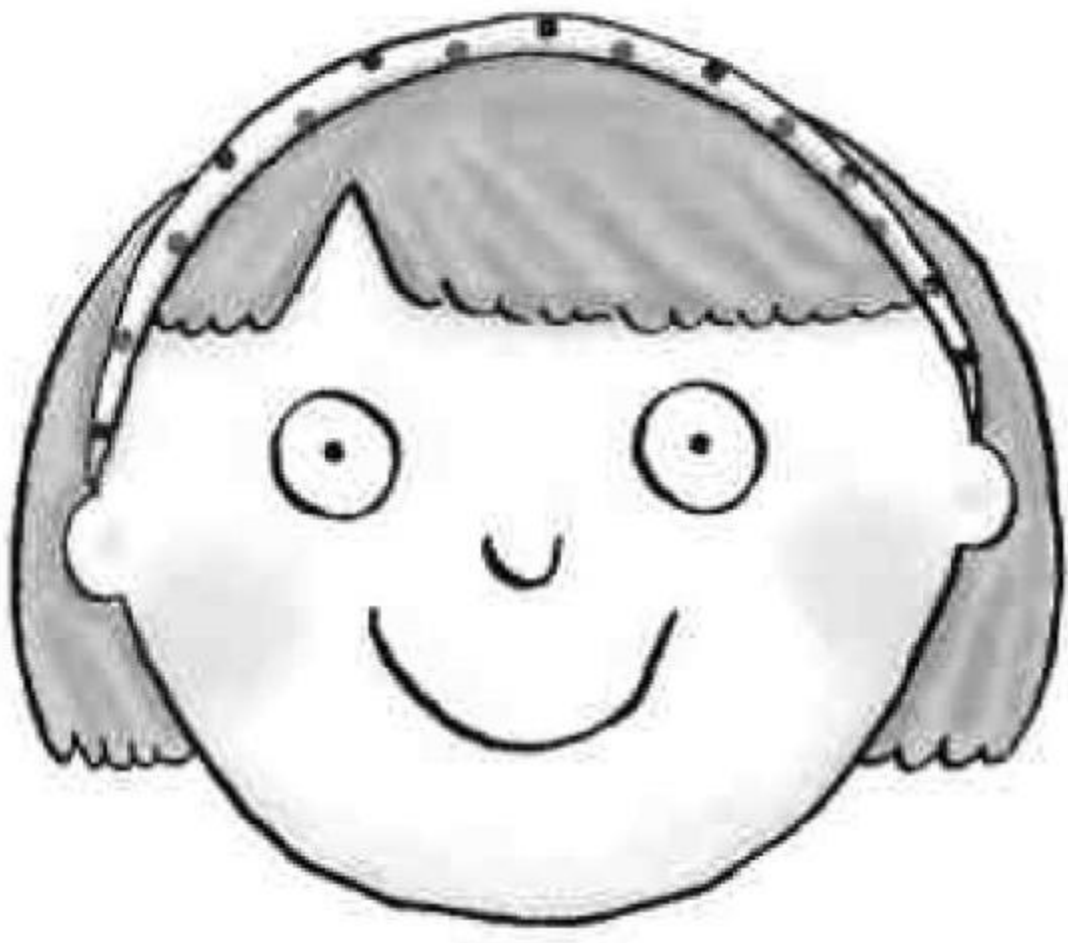

2



3



4

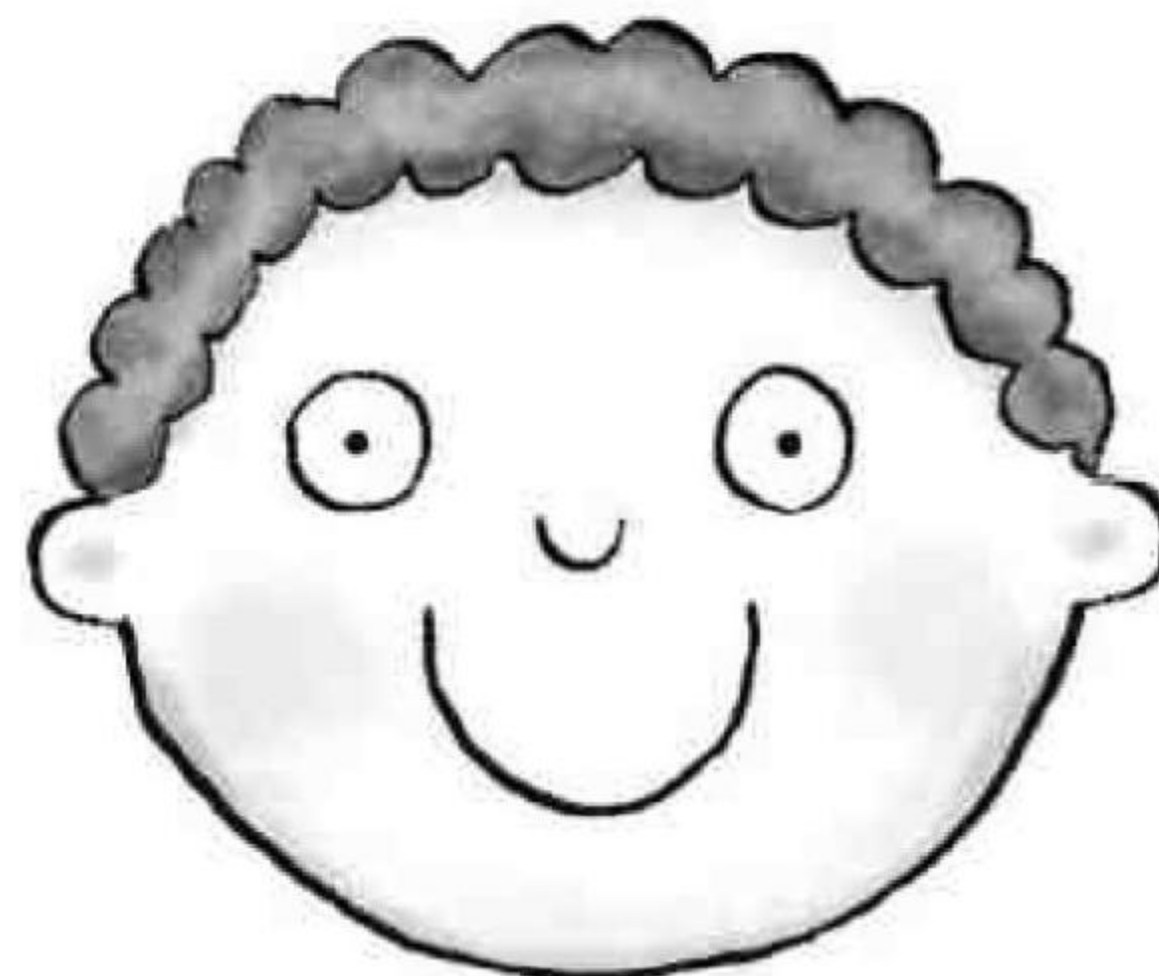
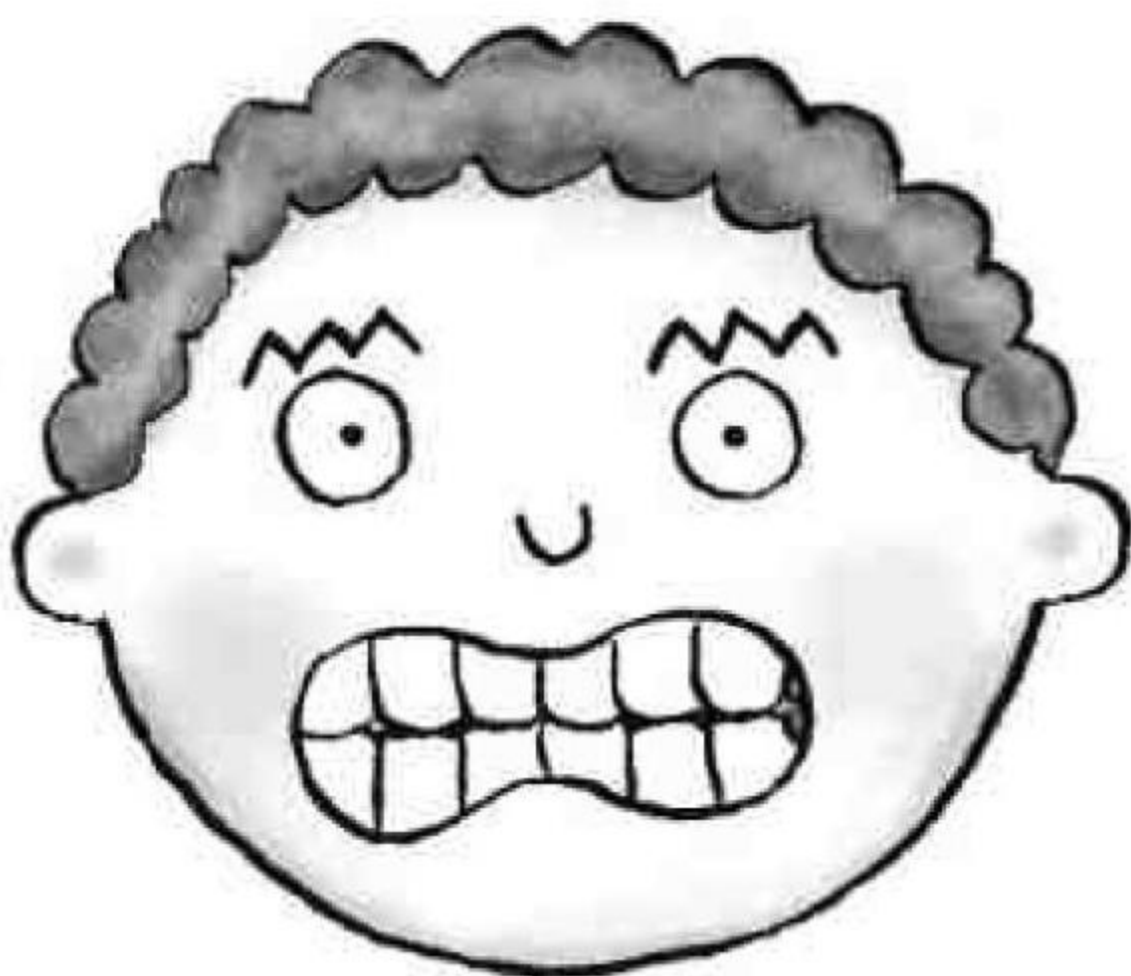

Are you (angry)? Yes, I am. / No, I'm not.

Listen and trace.

1



2



3

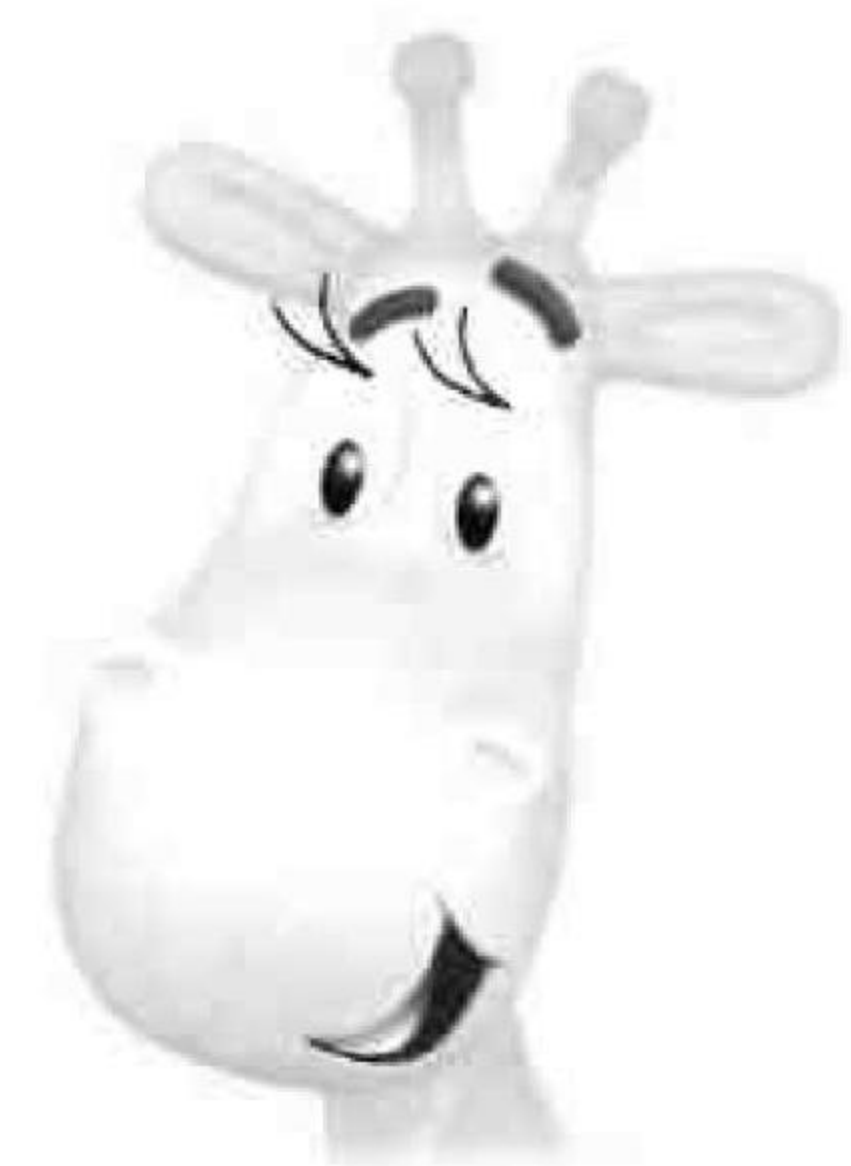

4



1 Think! Look and colour.

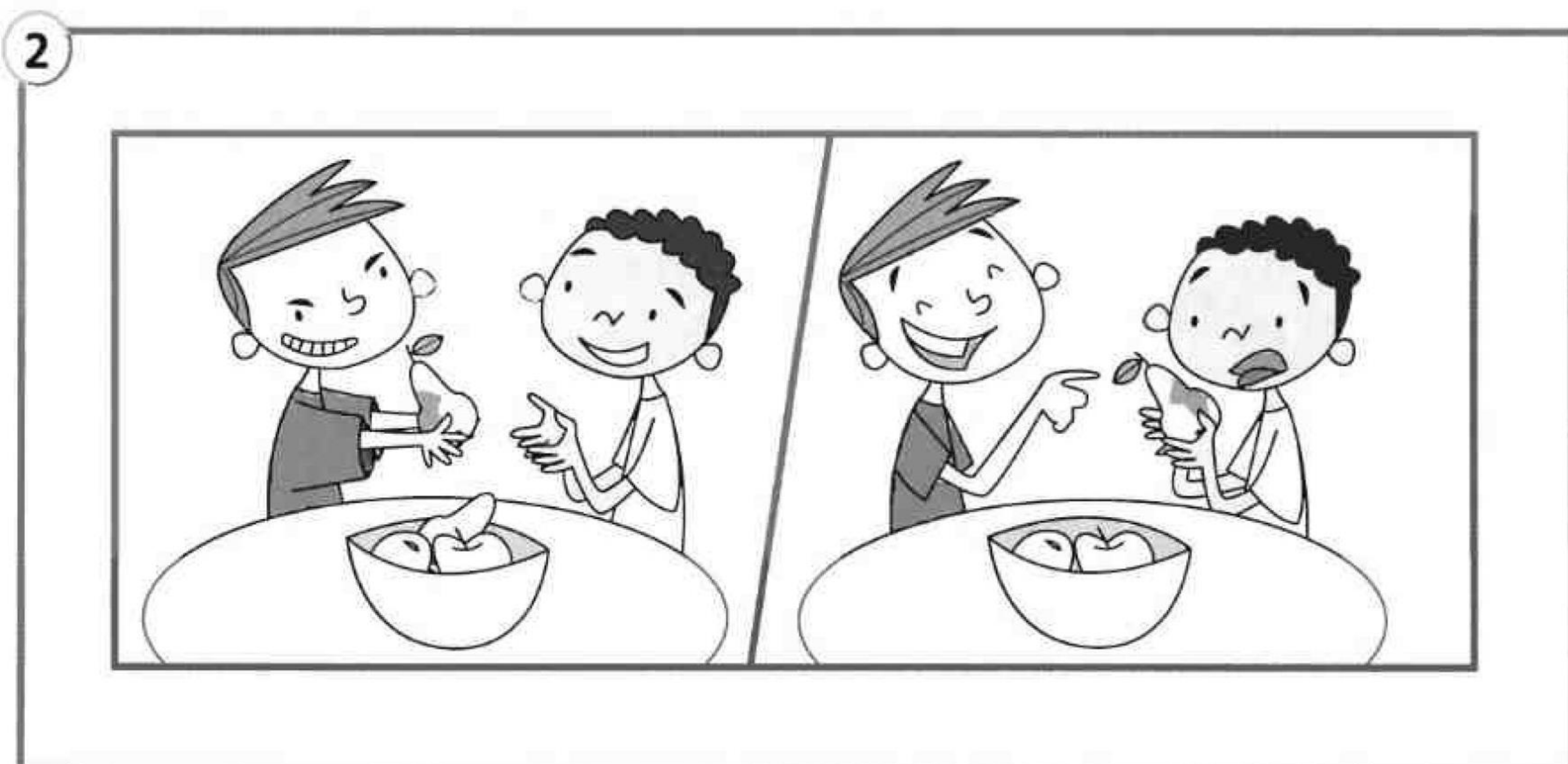
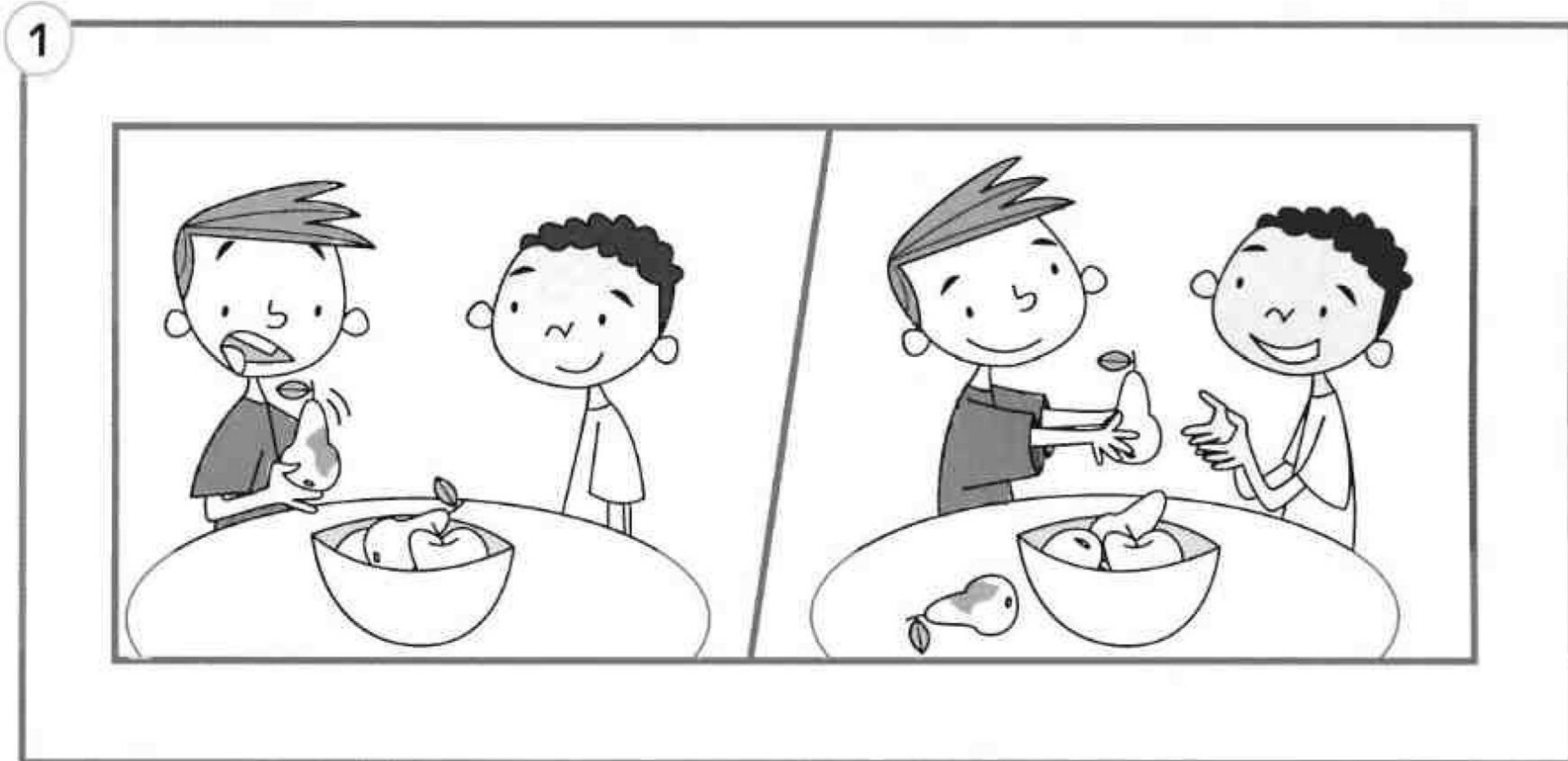

1 Think! Join the dots and answer.

1

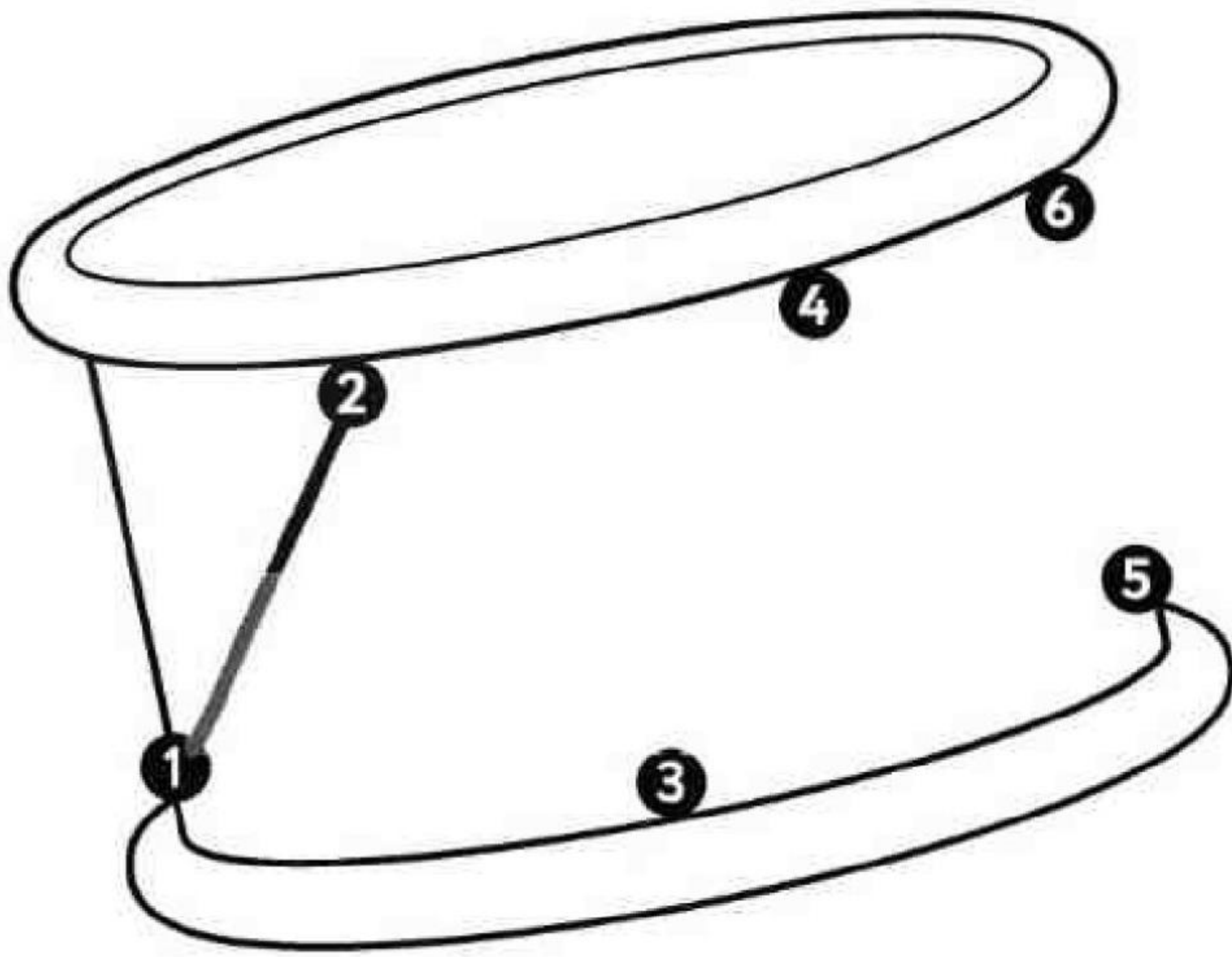

2

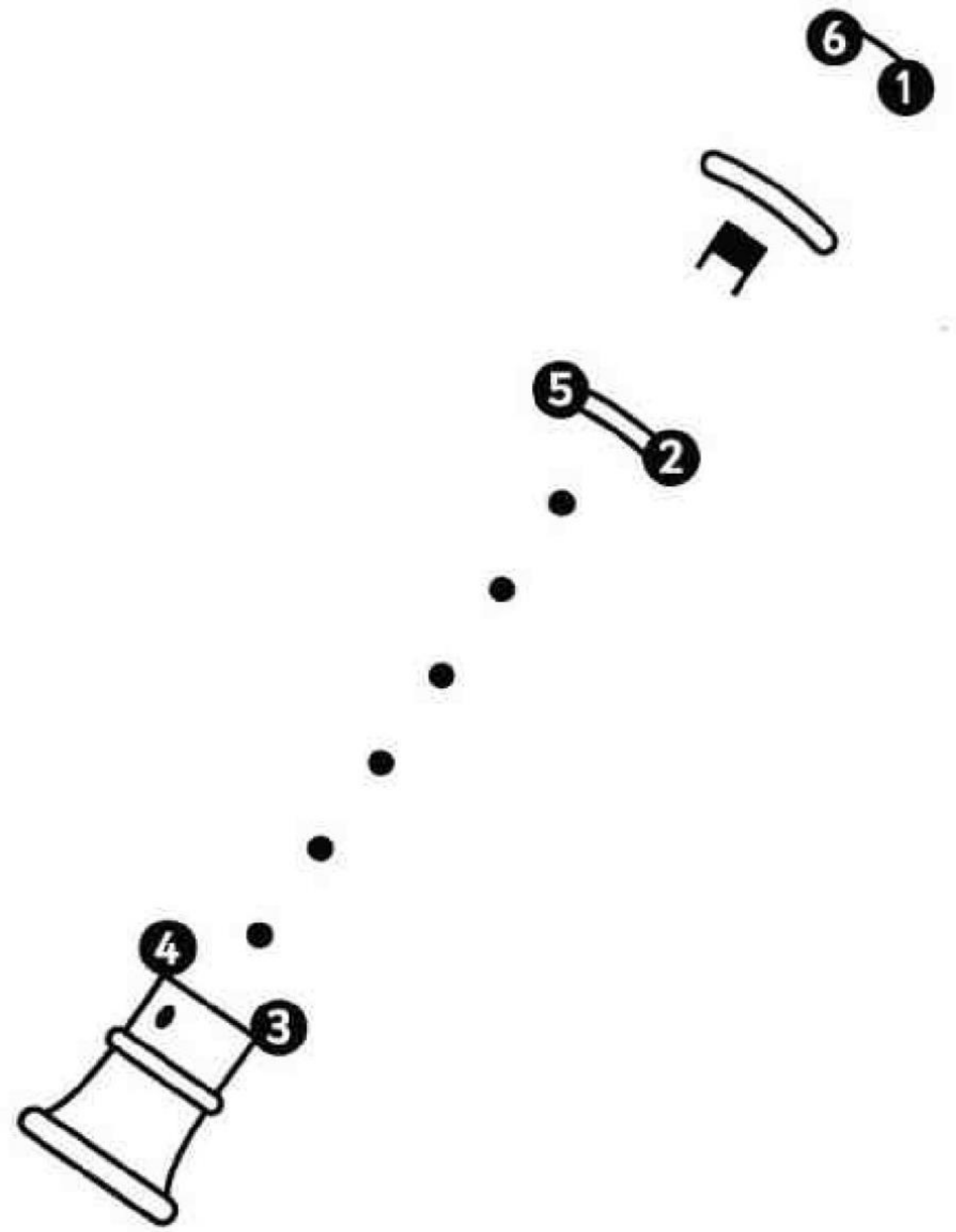

3

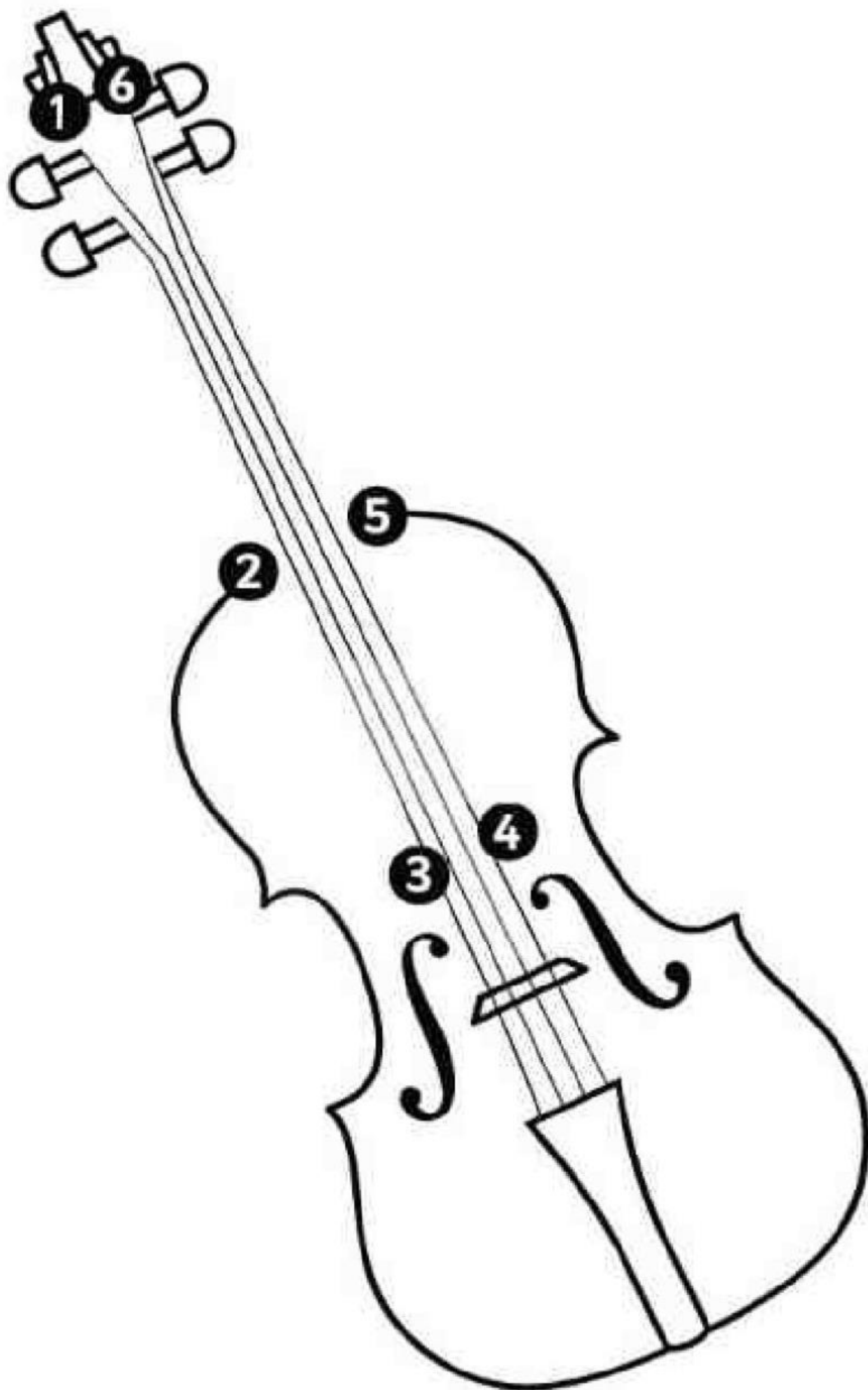

4

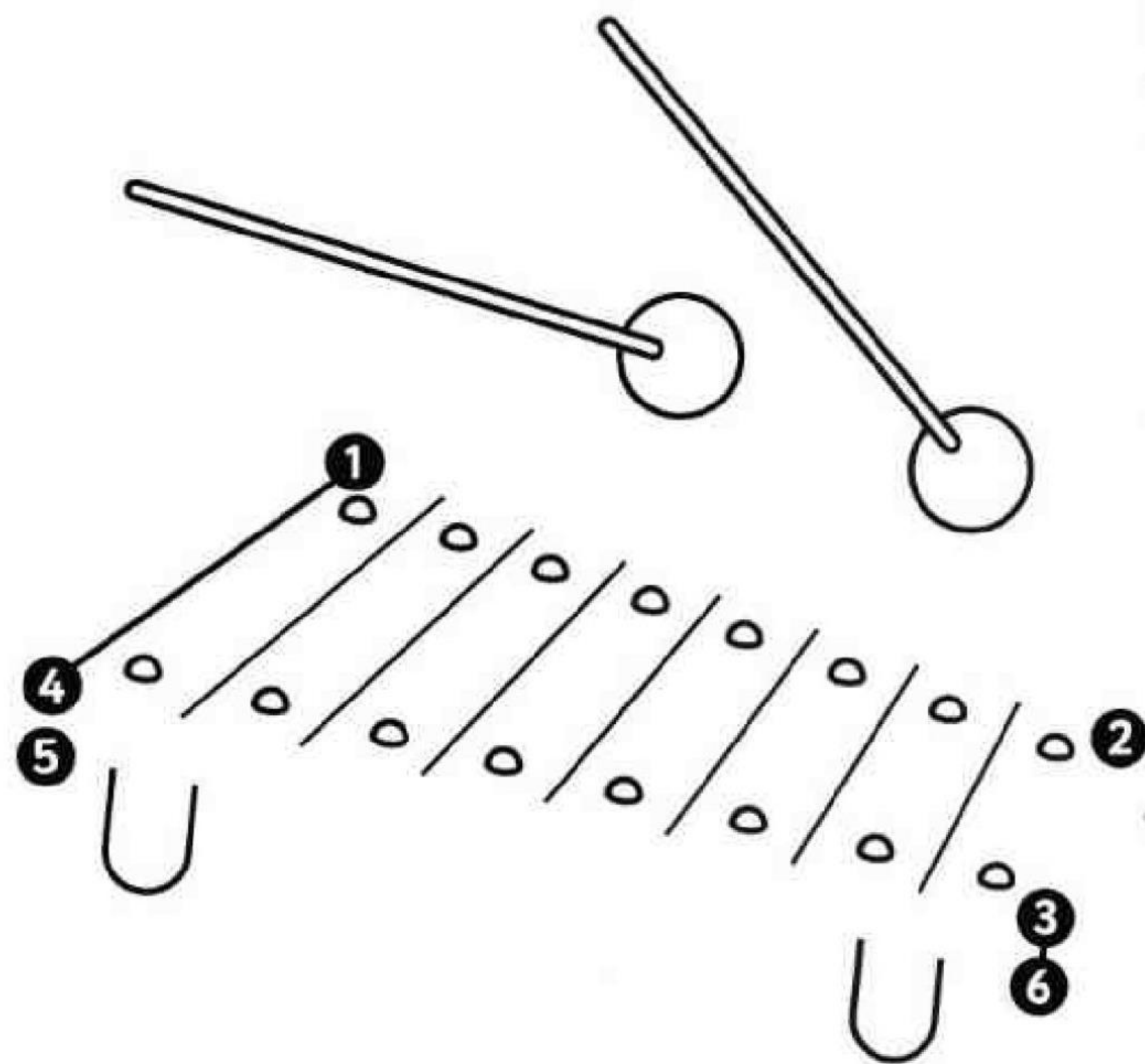

1 Think! Look and draw.

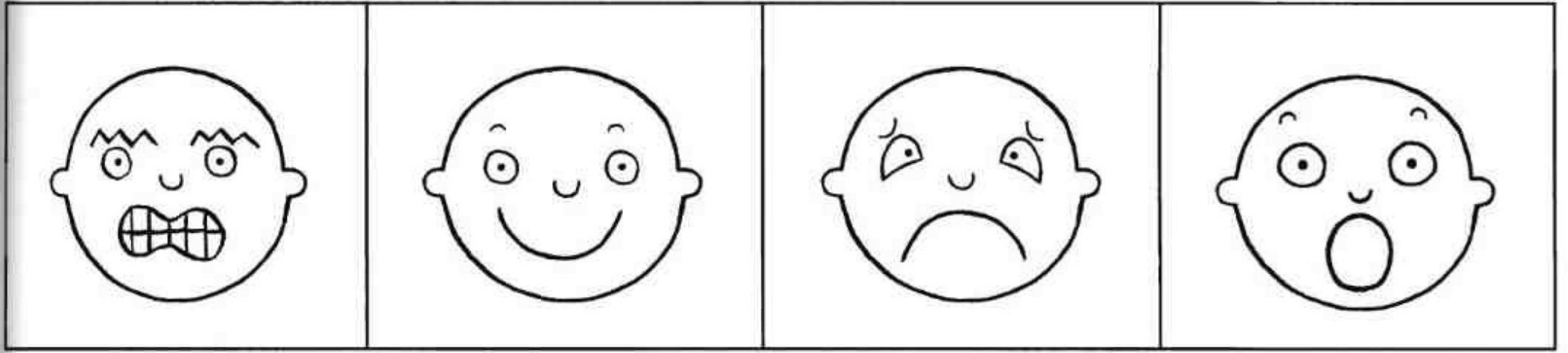

1 Make a xylophone.

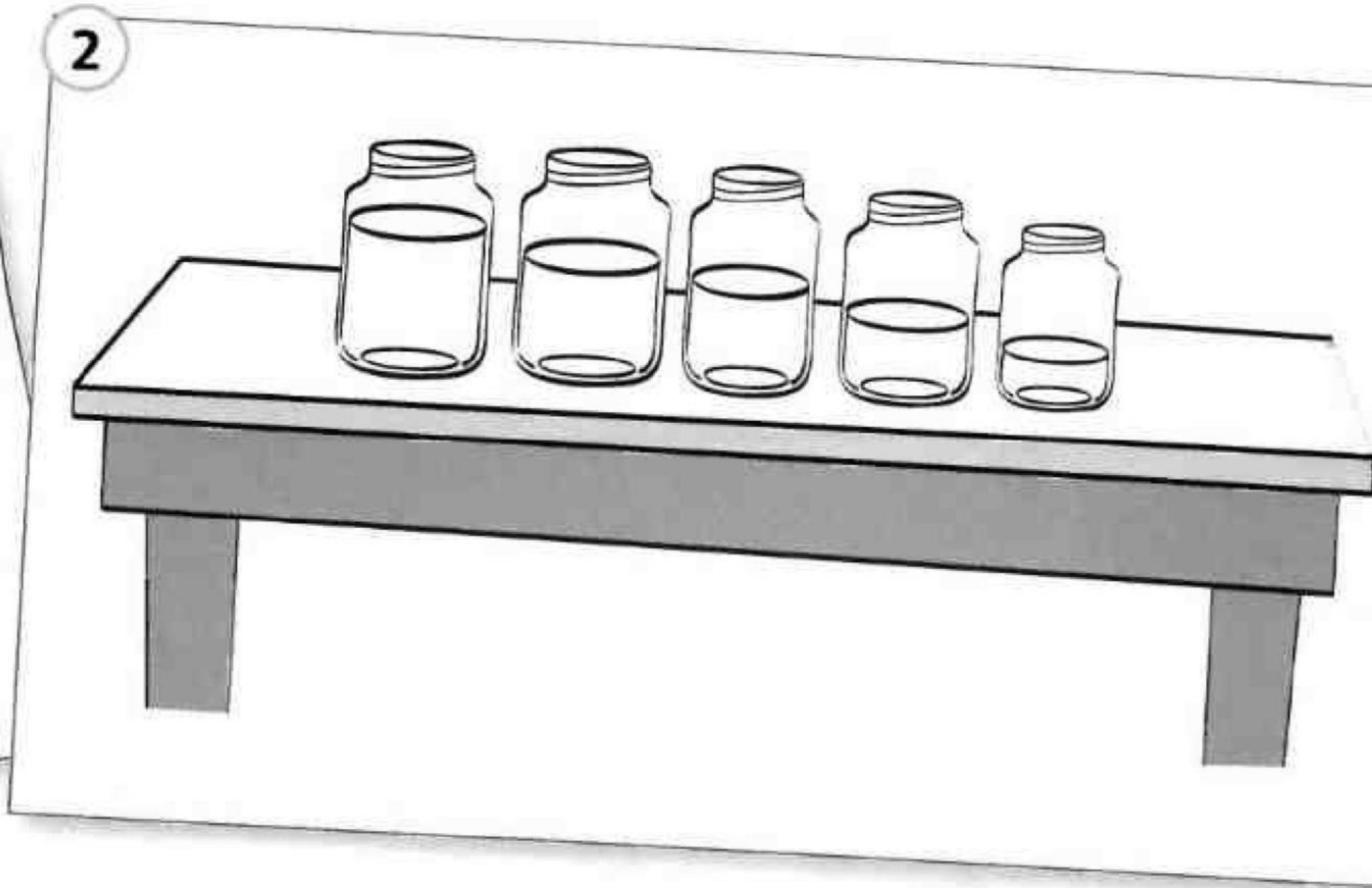

1 Say the words. Colour the circles.

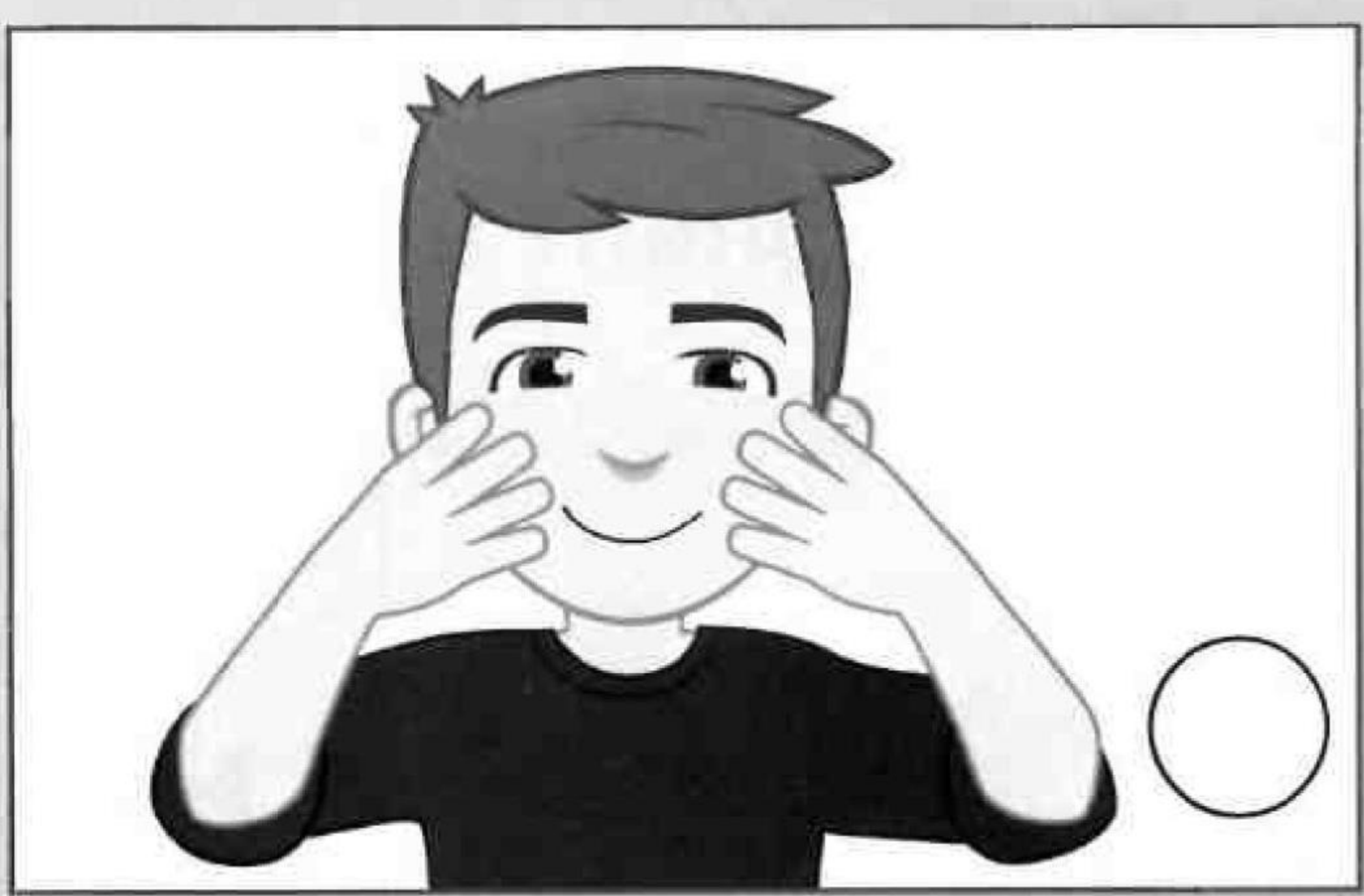
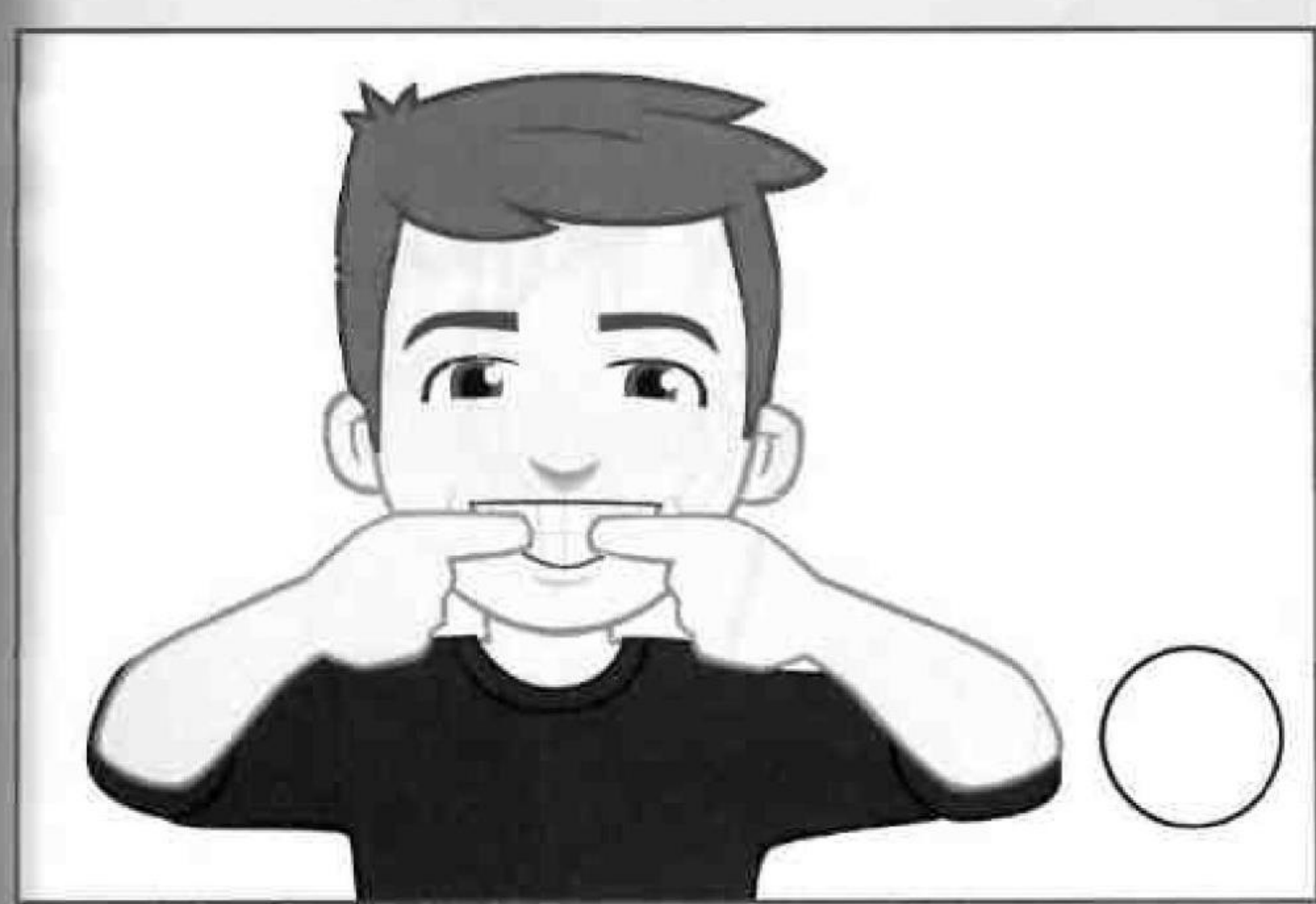
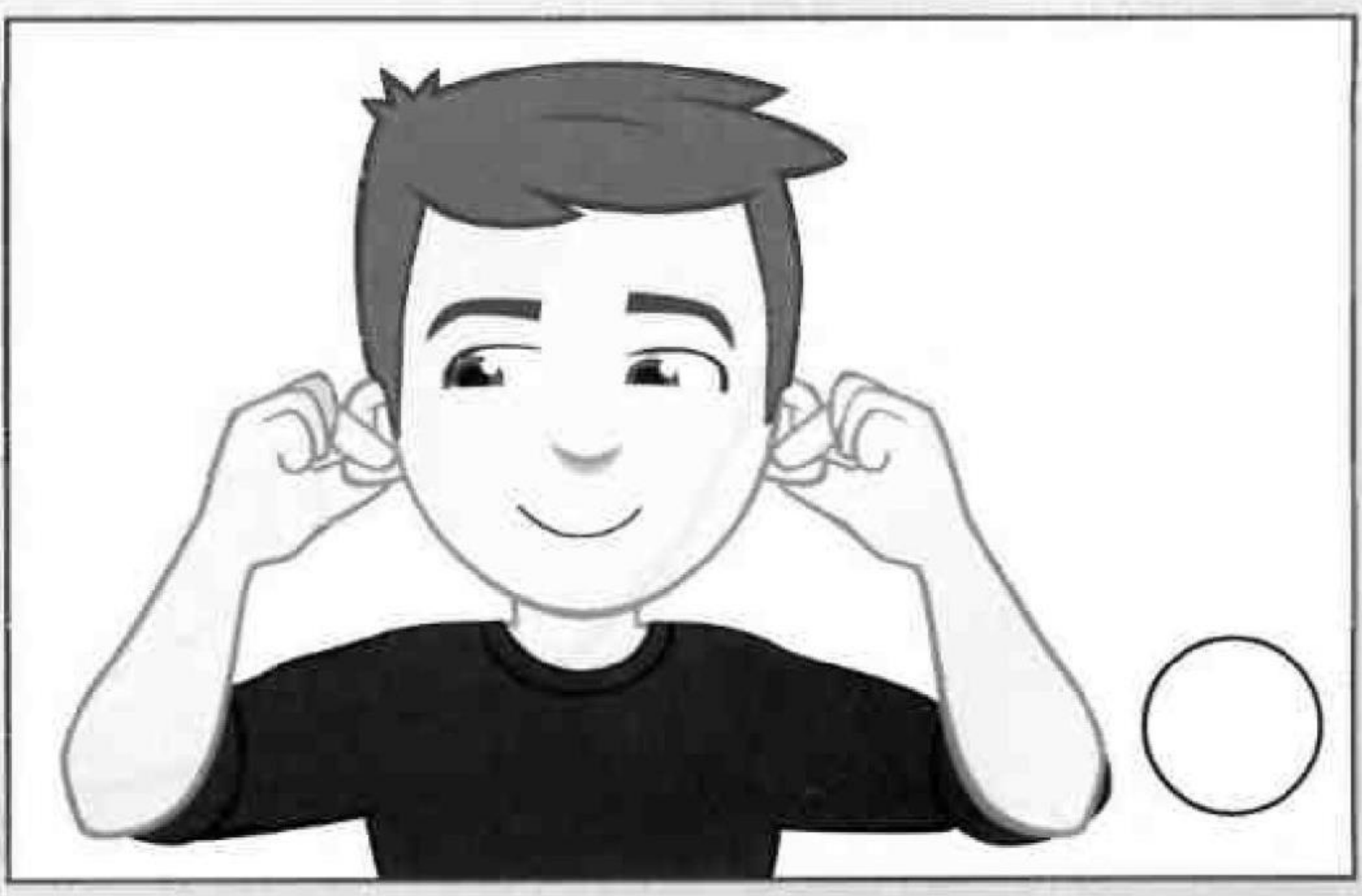
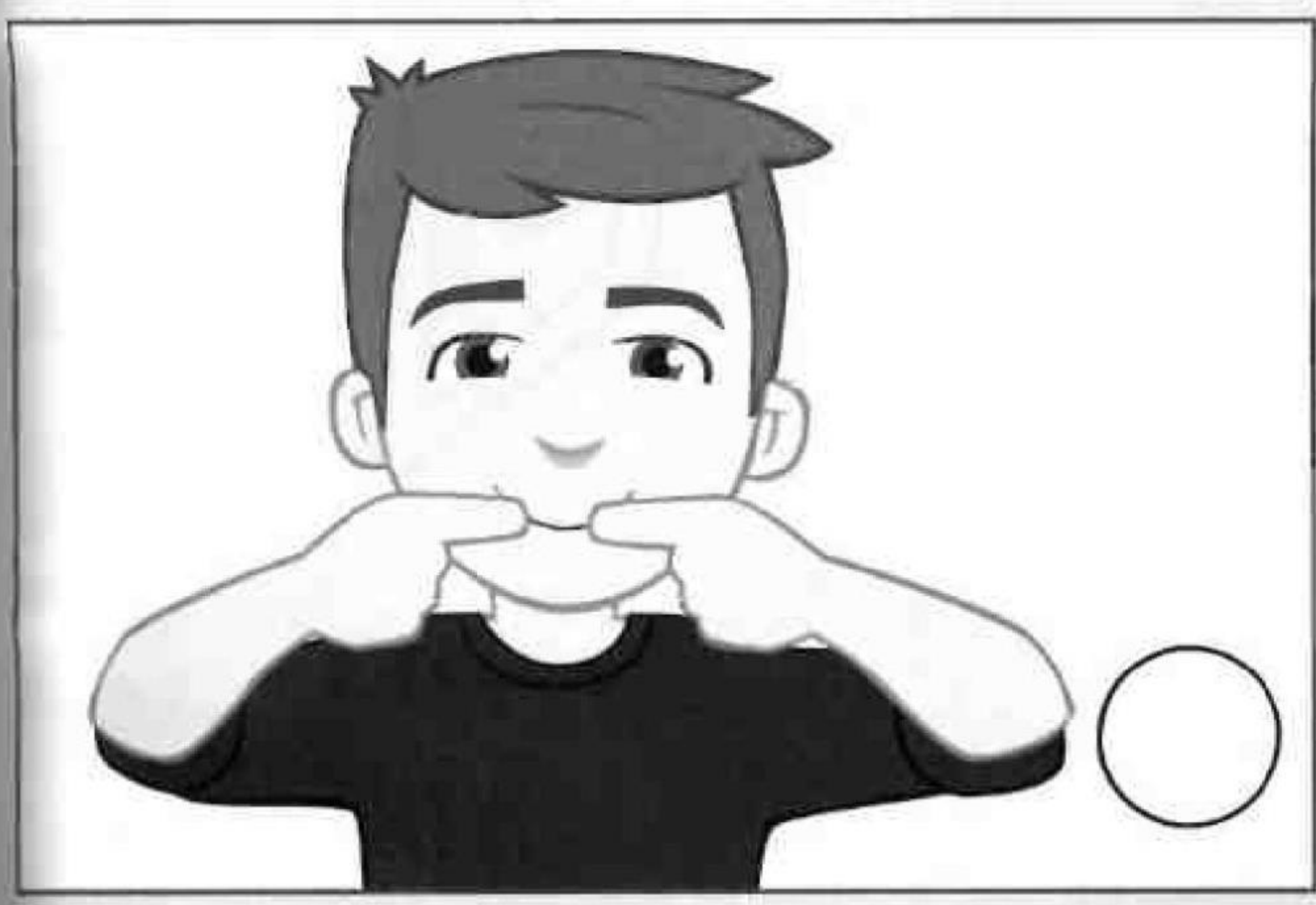
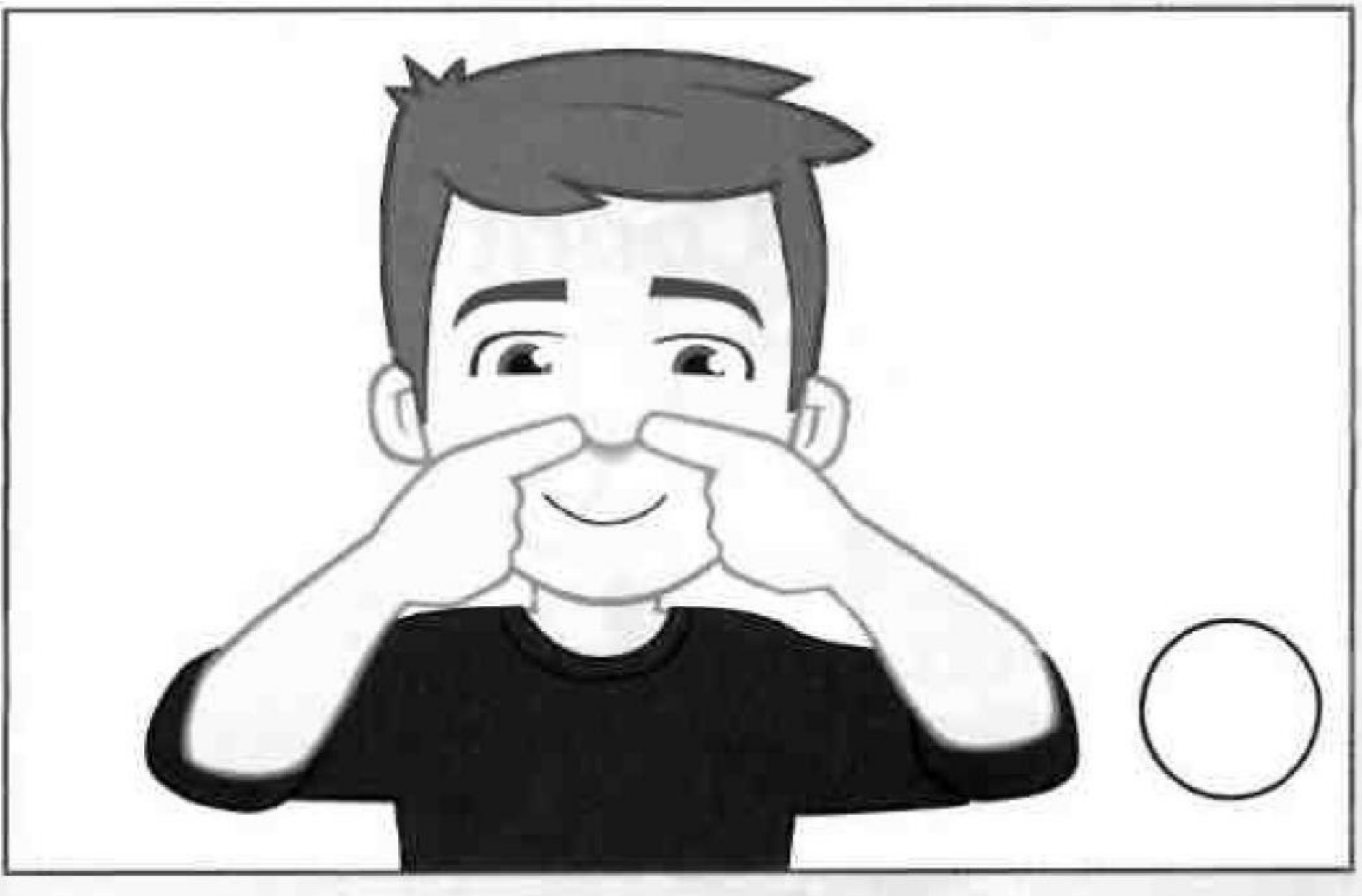
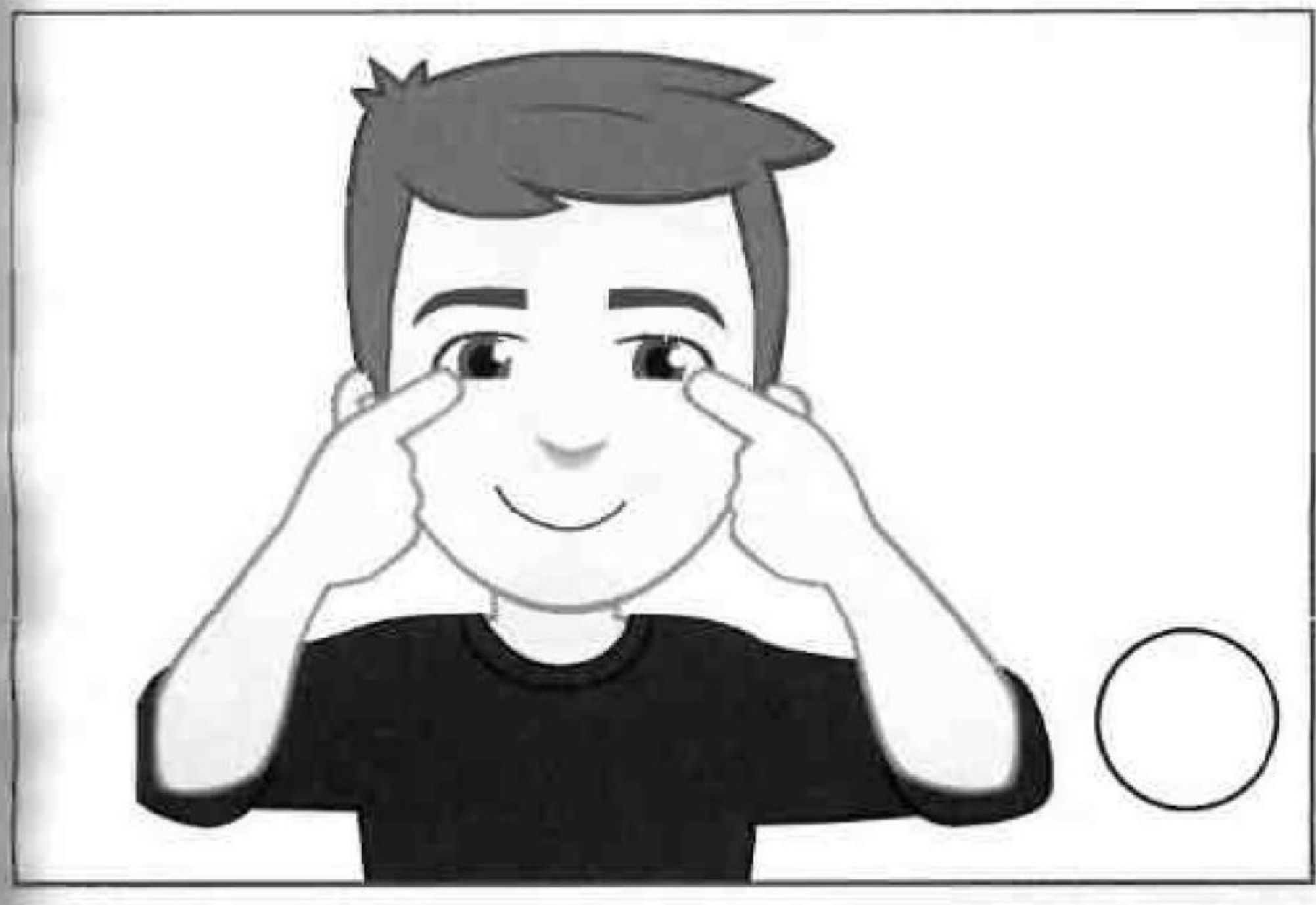

2 Draw faces. 😊 😐 ☹️

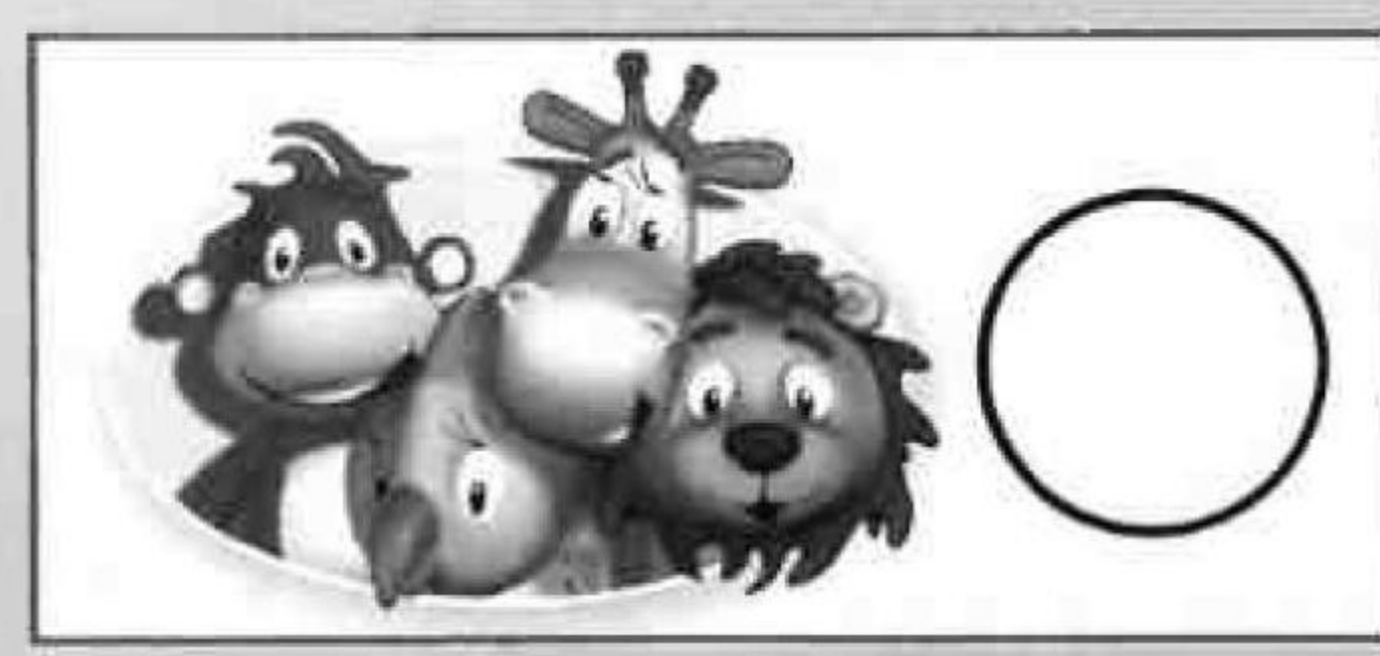
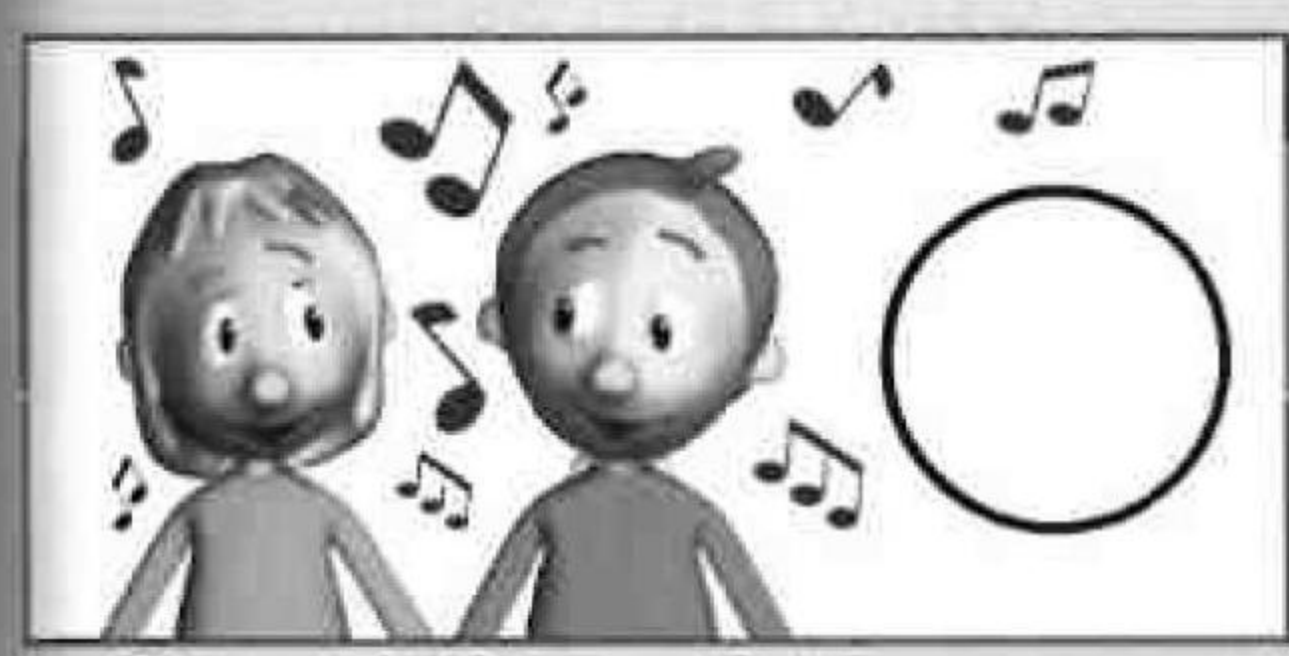

4

Toys

1 Think! Count and match.

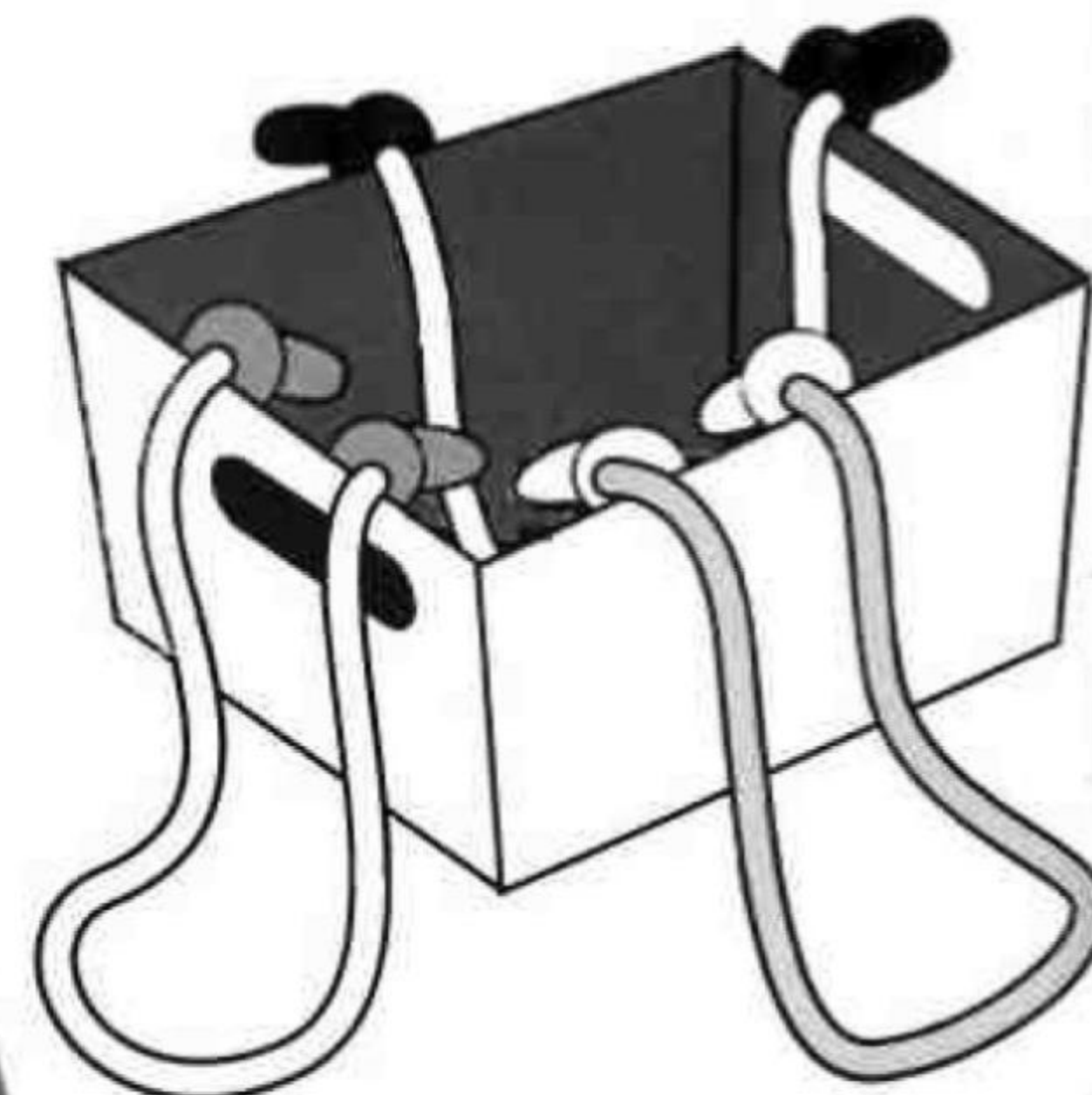
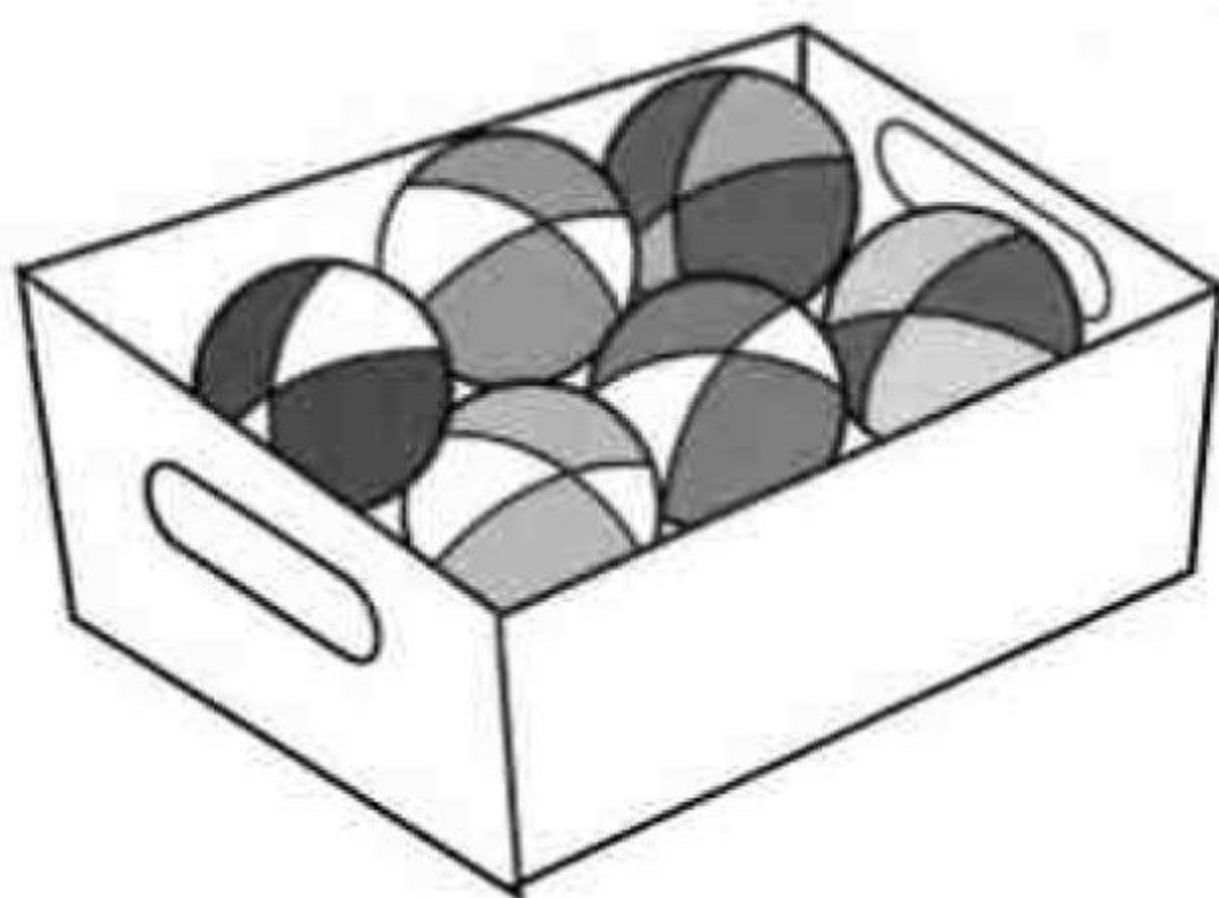
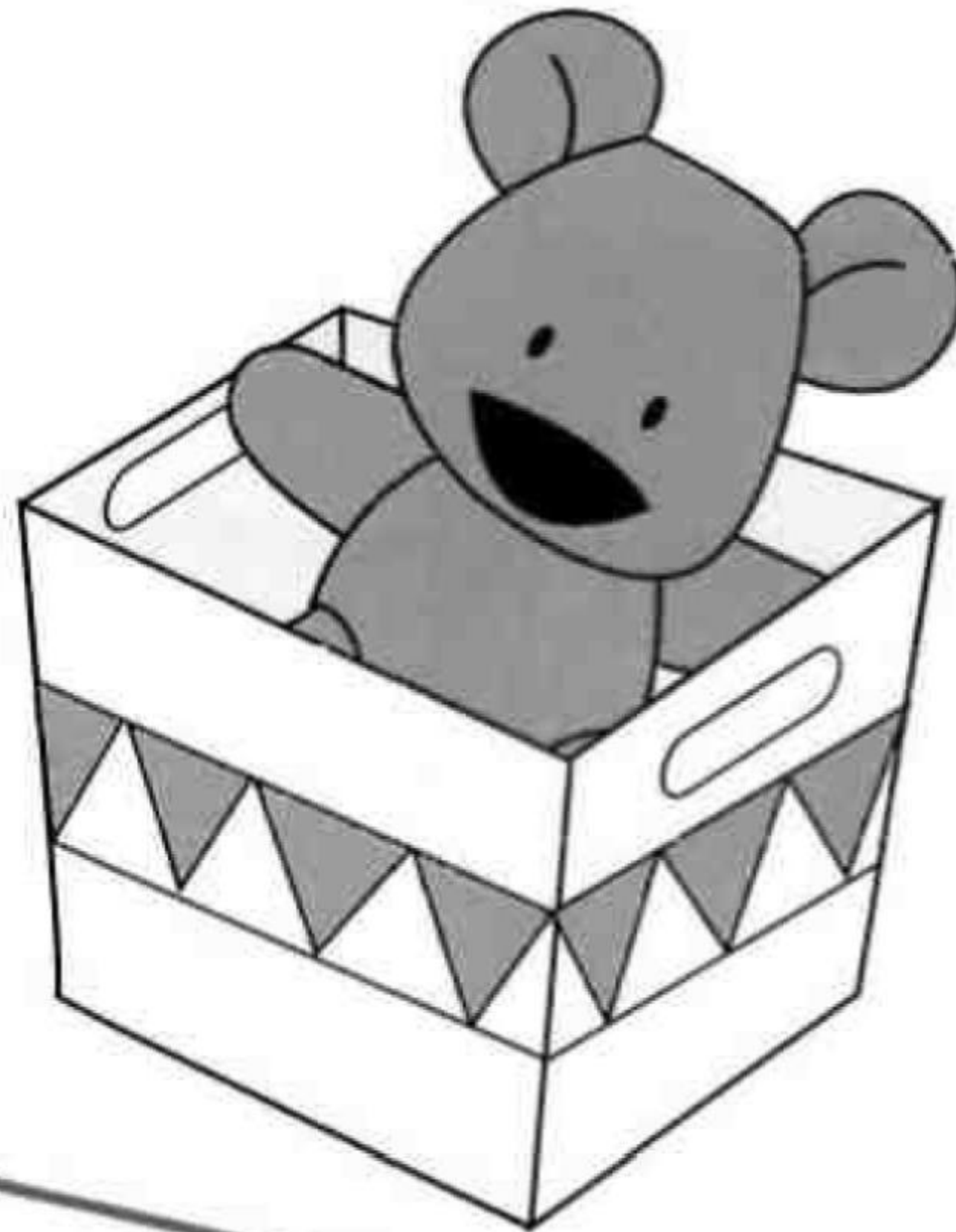
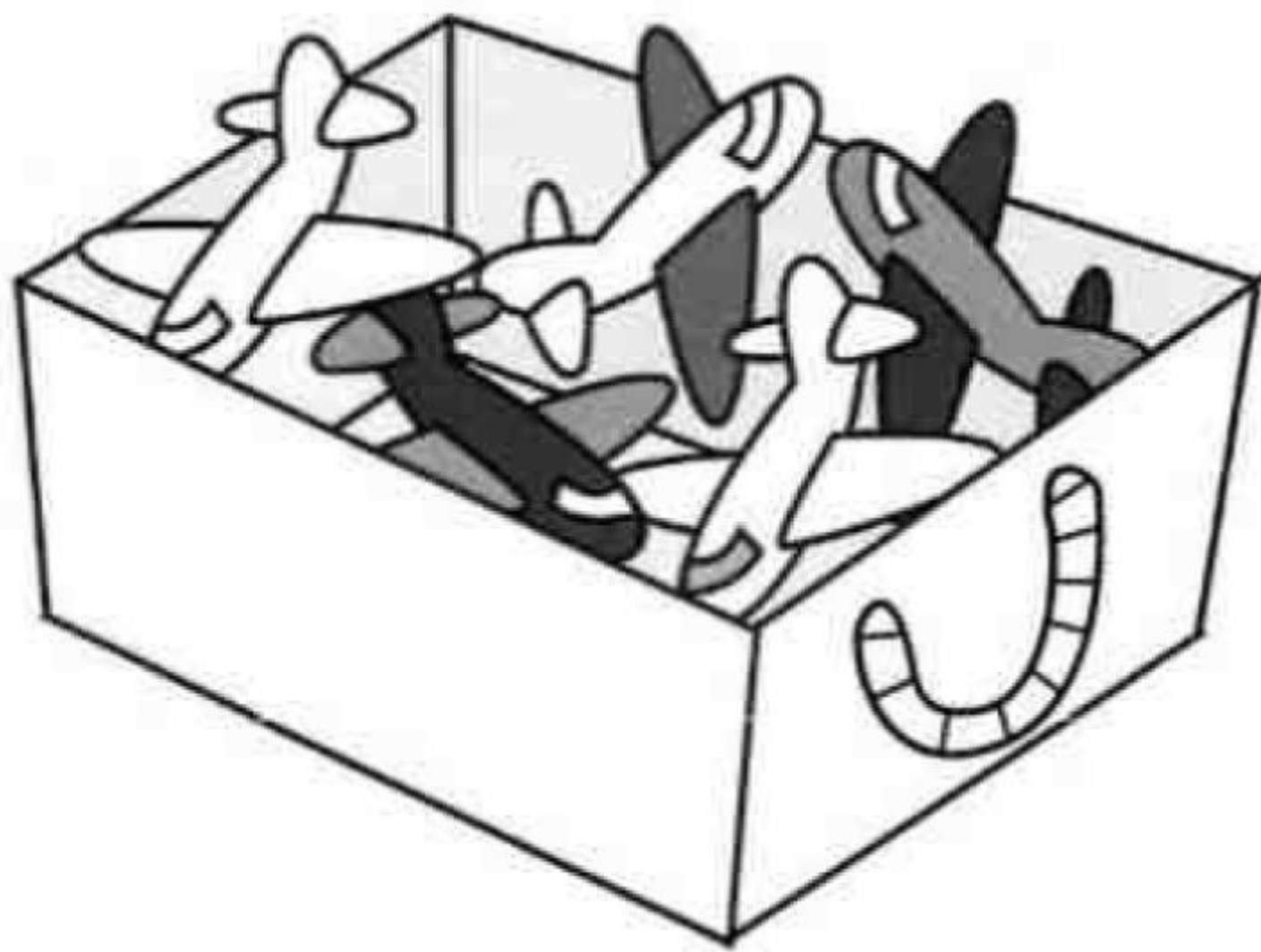

1

2

3

4

5

6

1 Draw four toys.

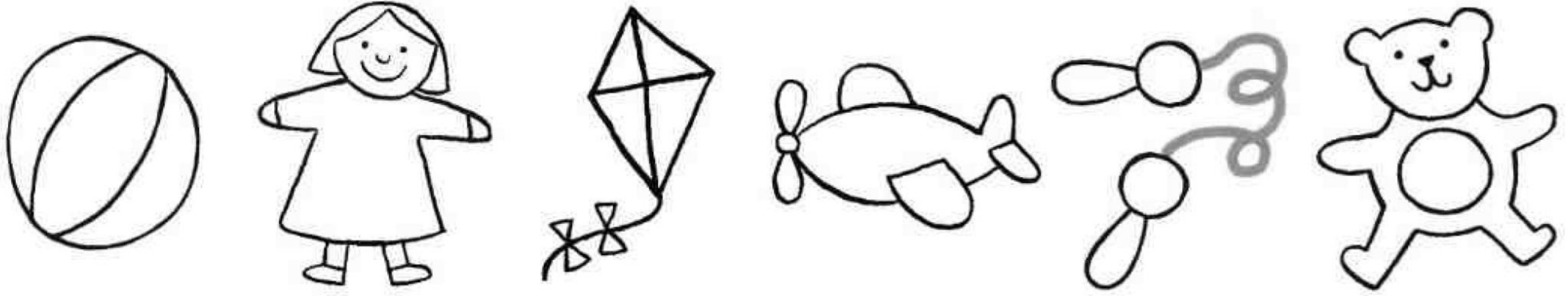

2 Describe your picture. Draw your friend's picture.



1 Complete the toys. Draw the missing toy.

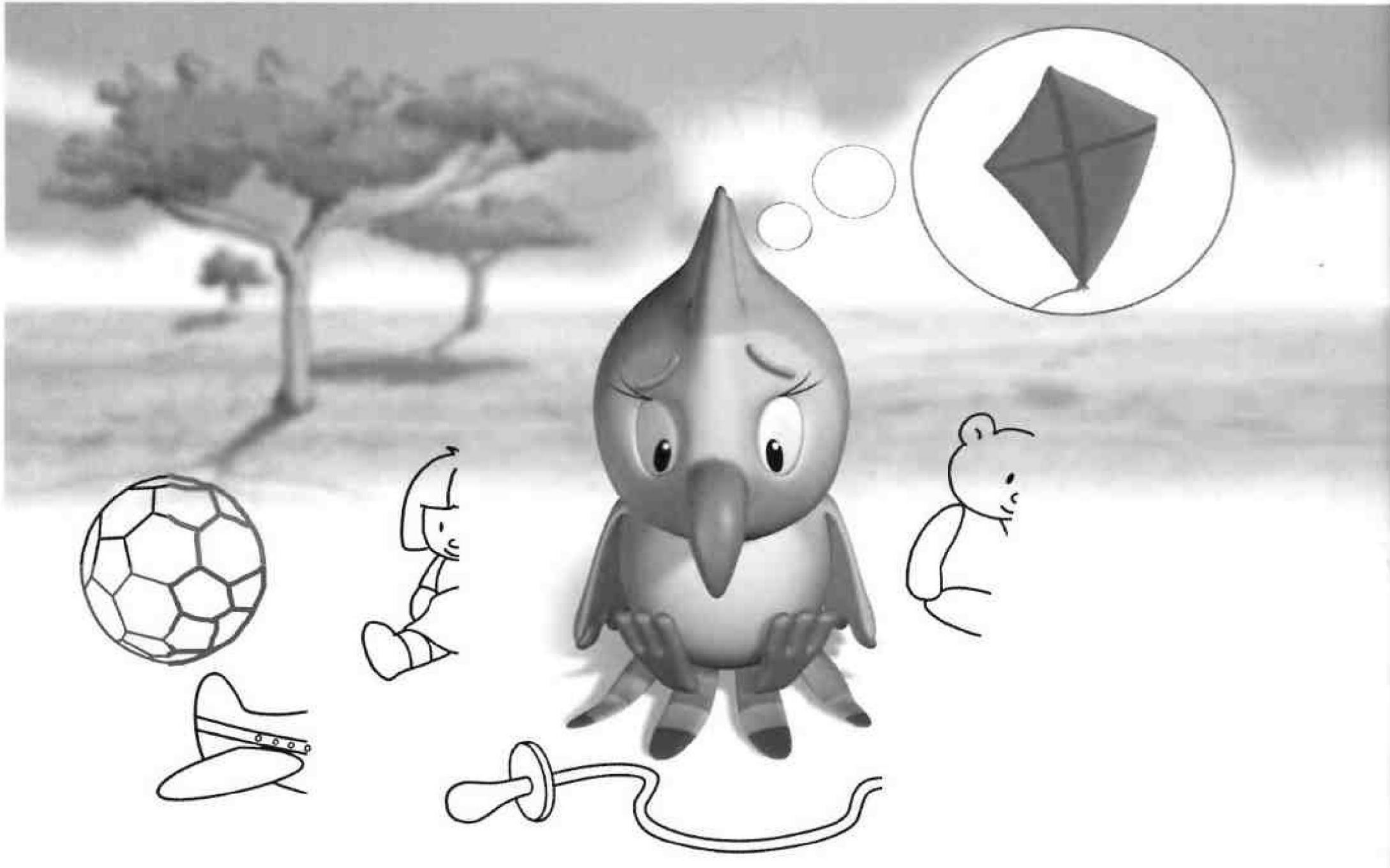

CD1
53

Listen and colour.

7 8 9 10

2 Think! Count and draw.

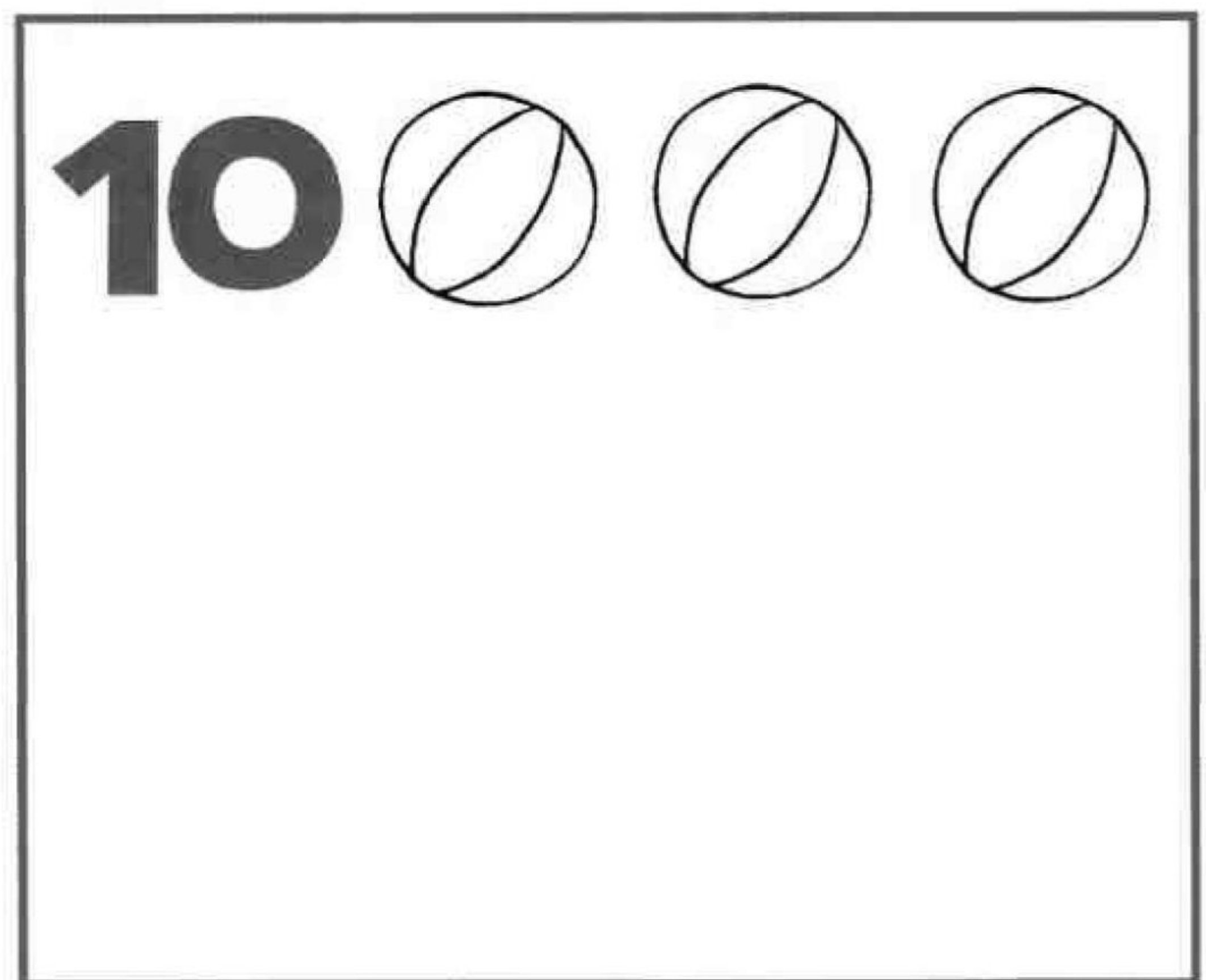
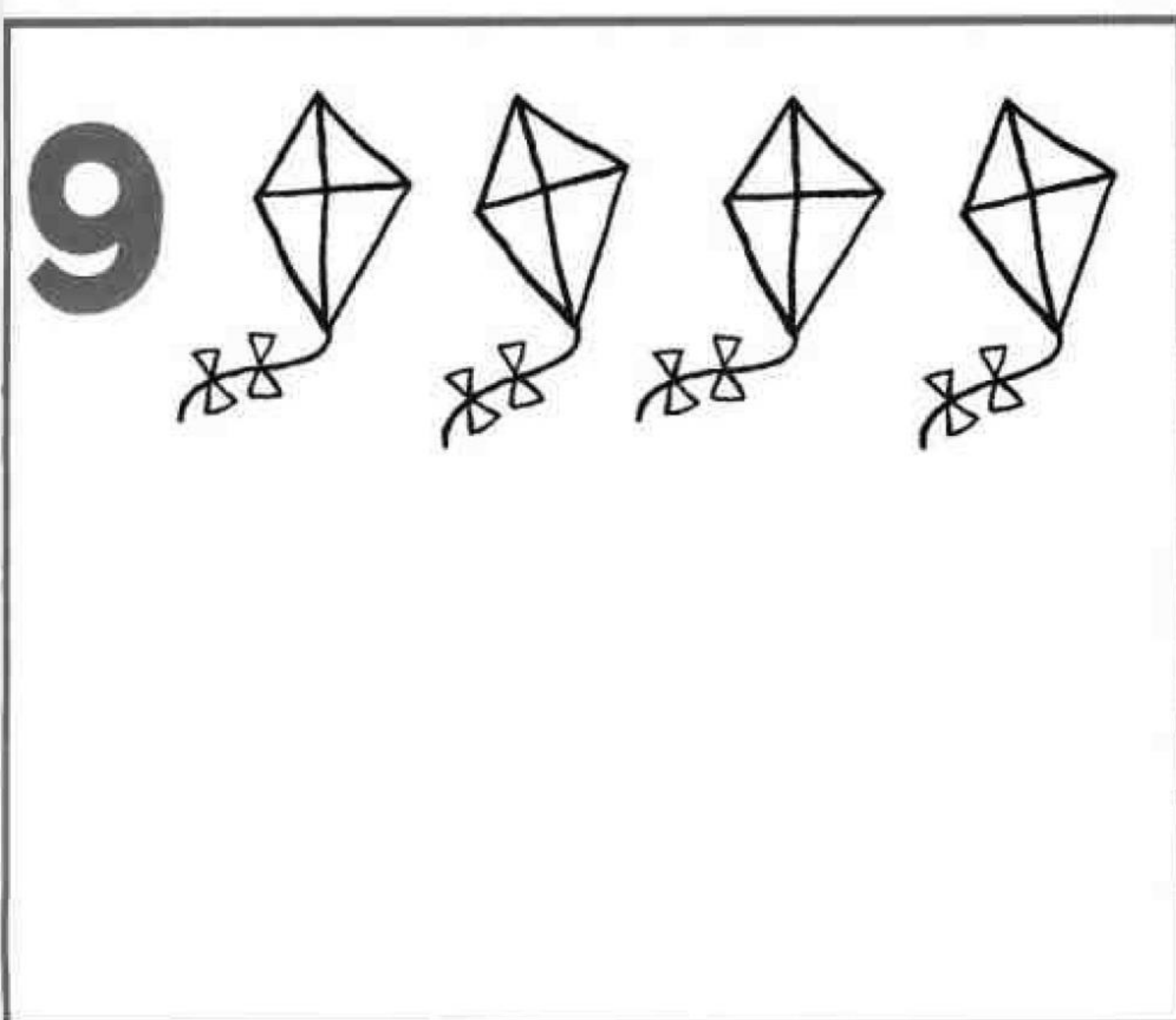
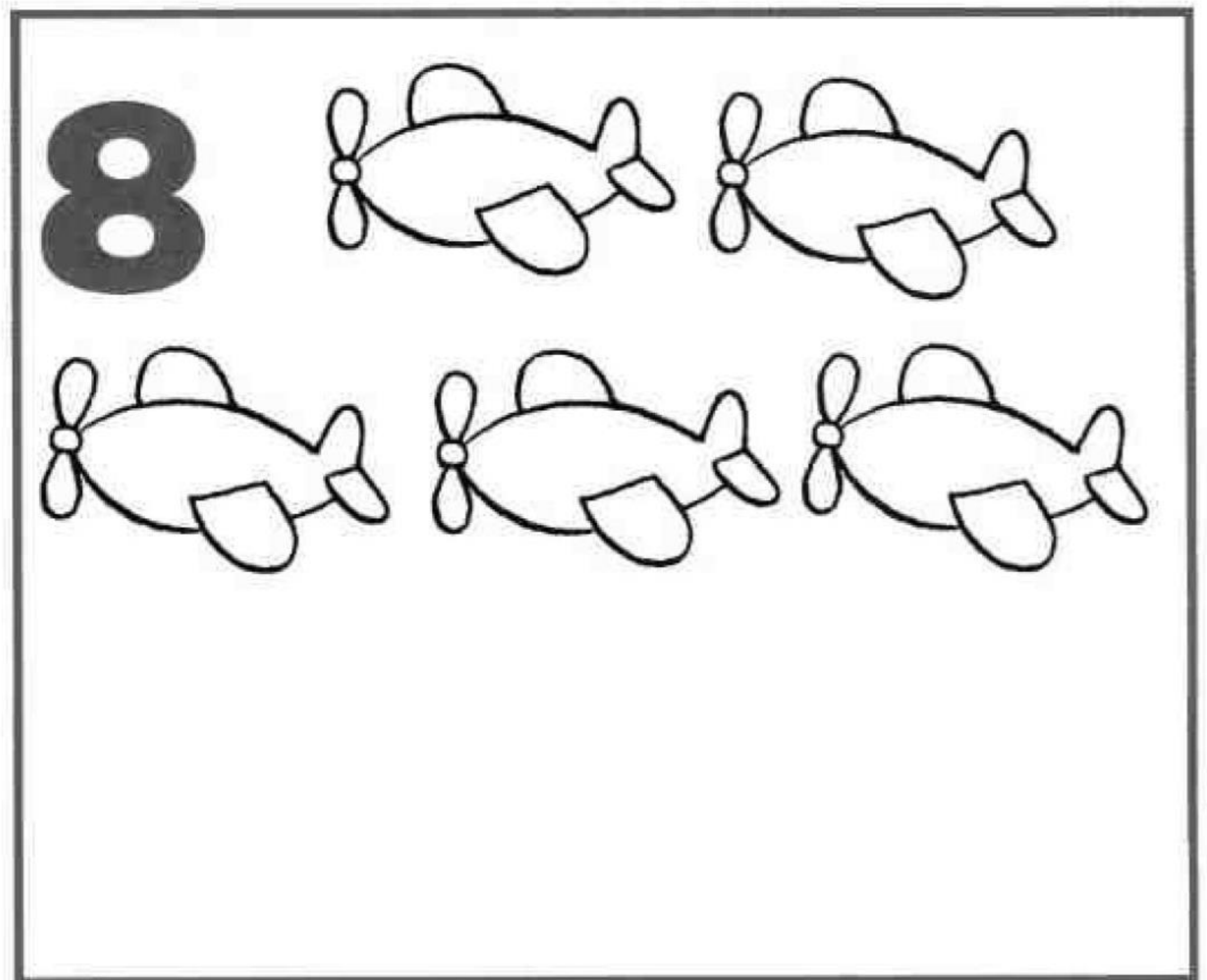
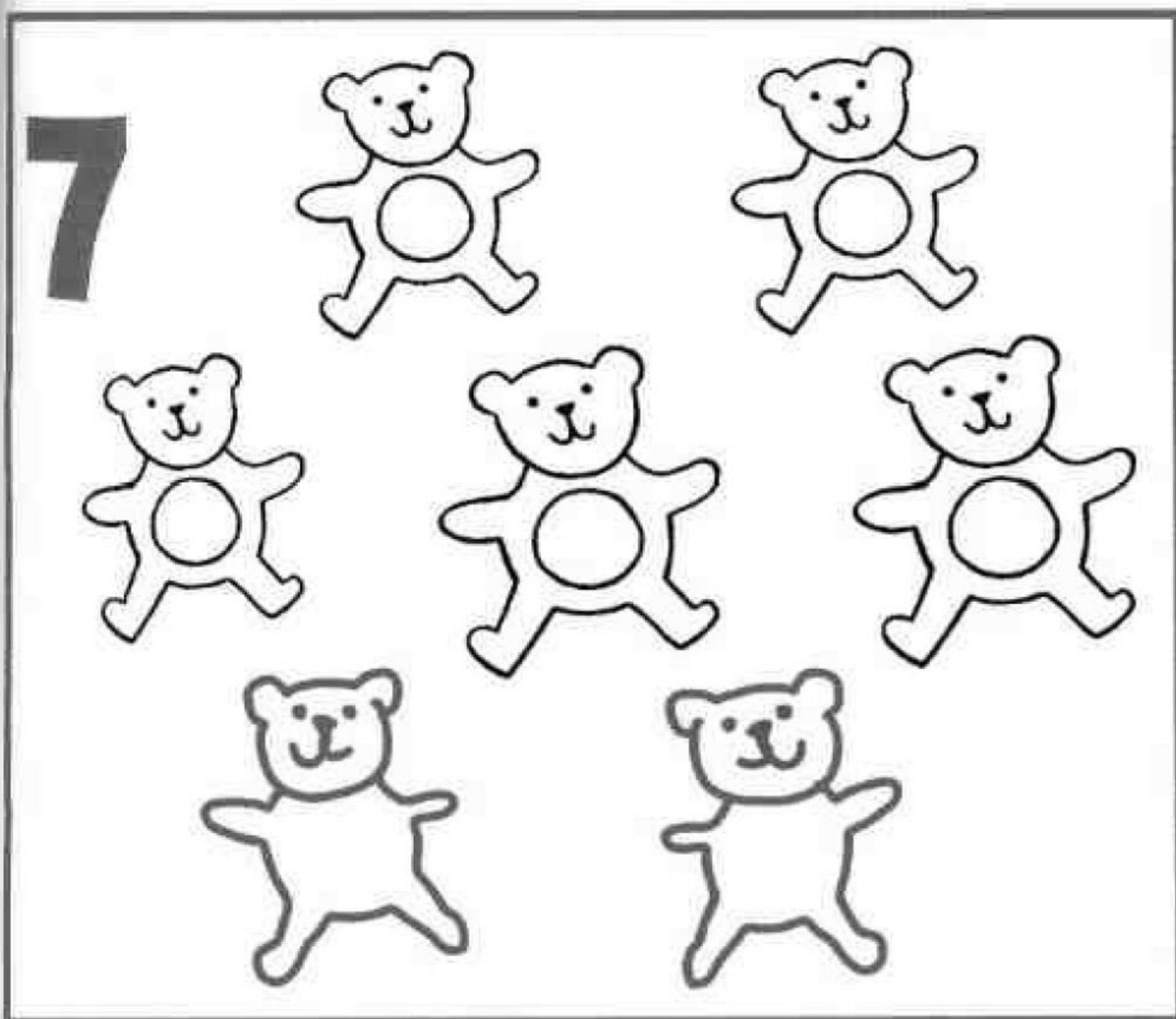

Listen and trace.

1



2



3

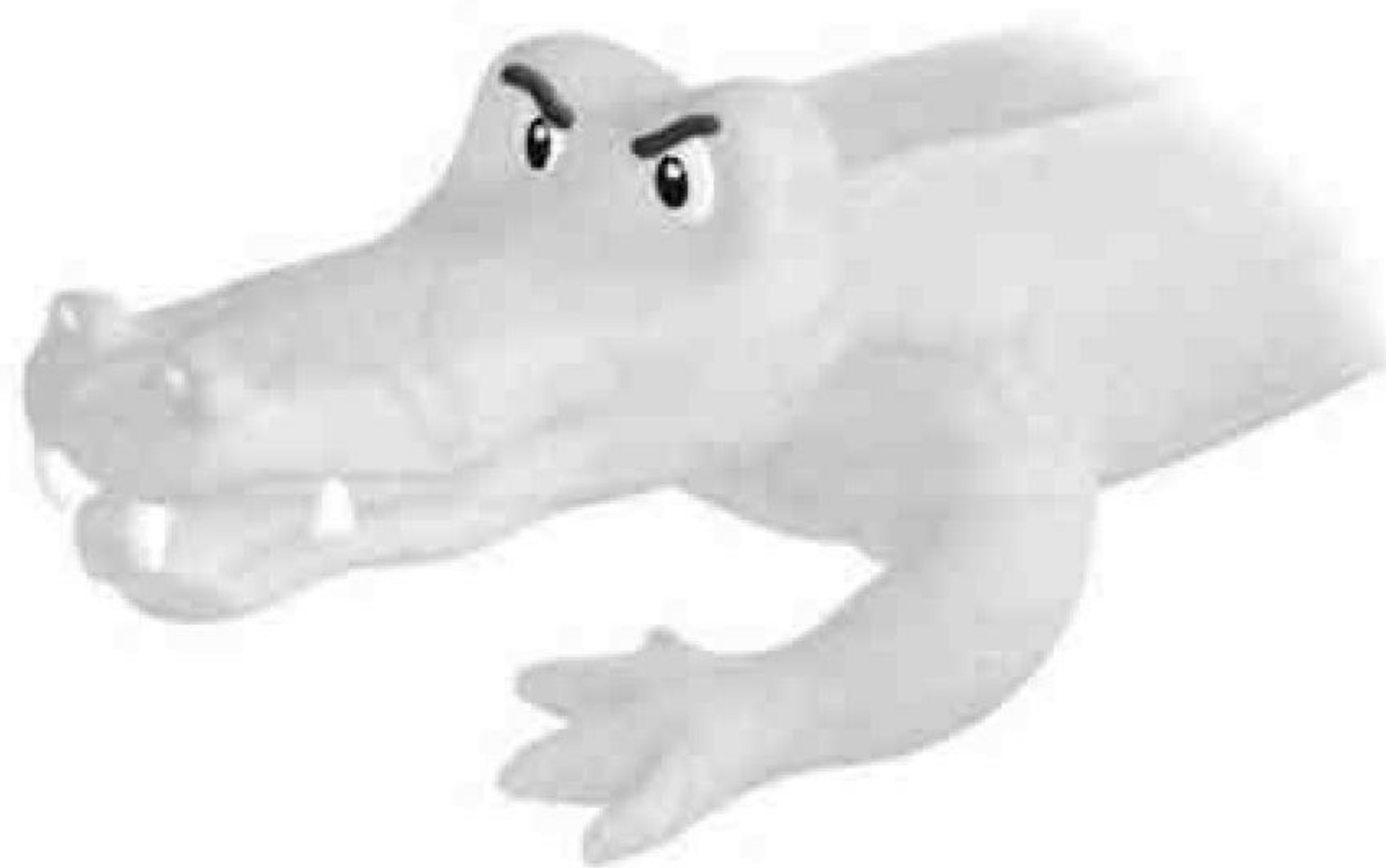
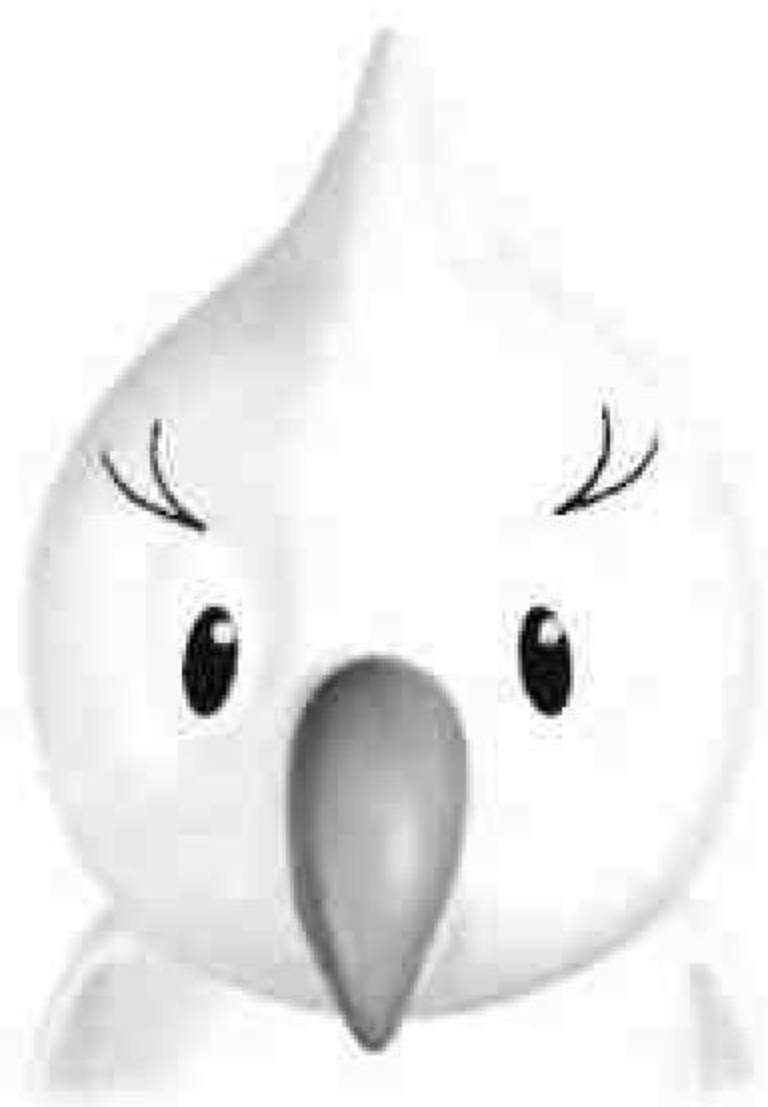

4



1 Think! Look and colour.



1

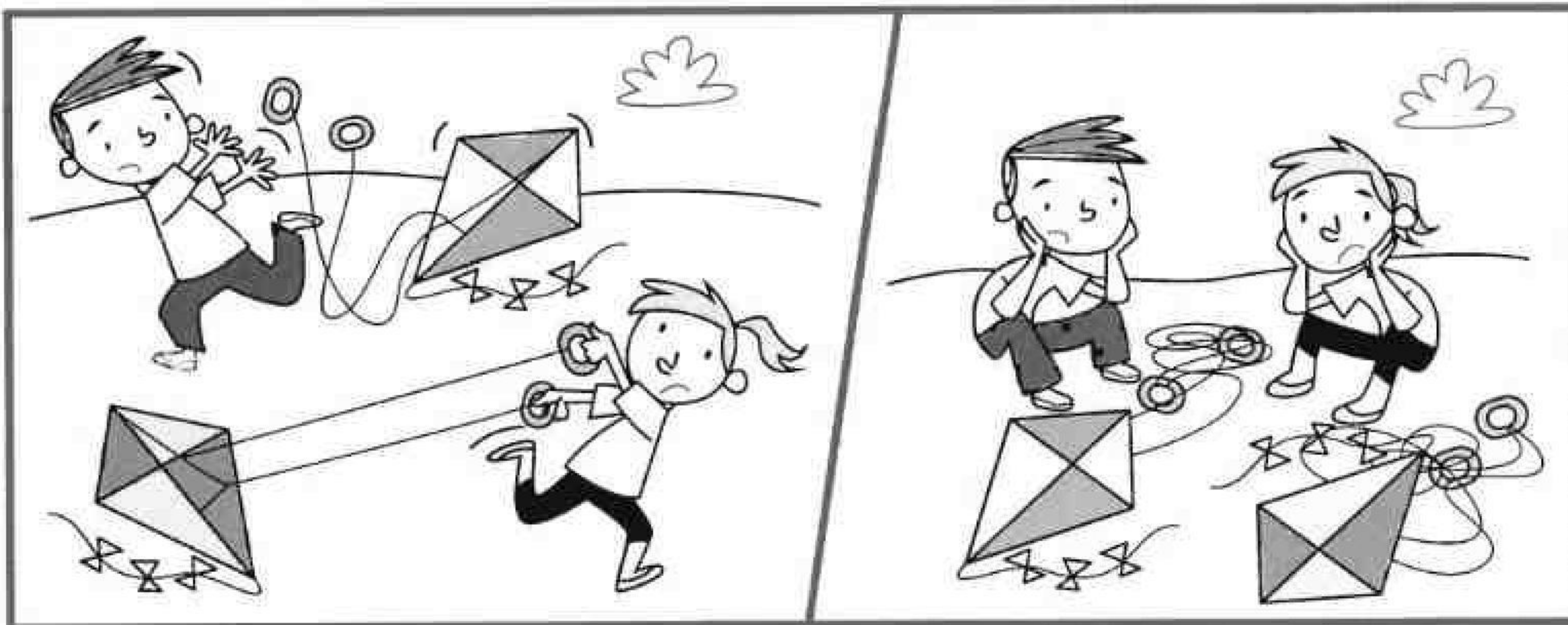

2

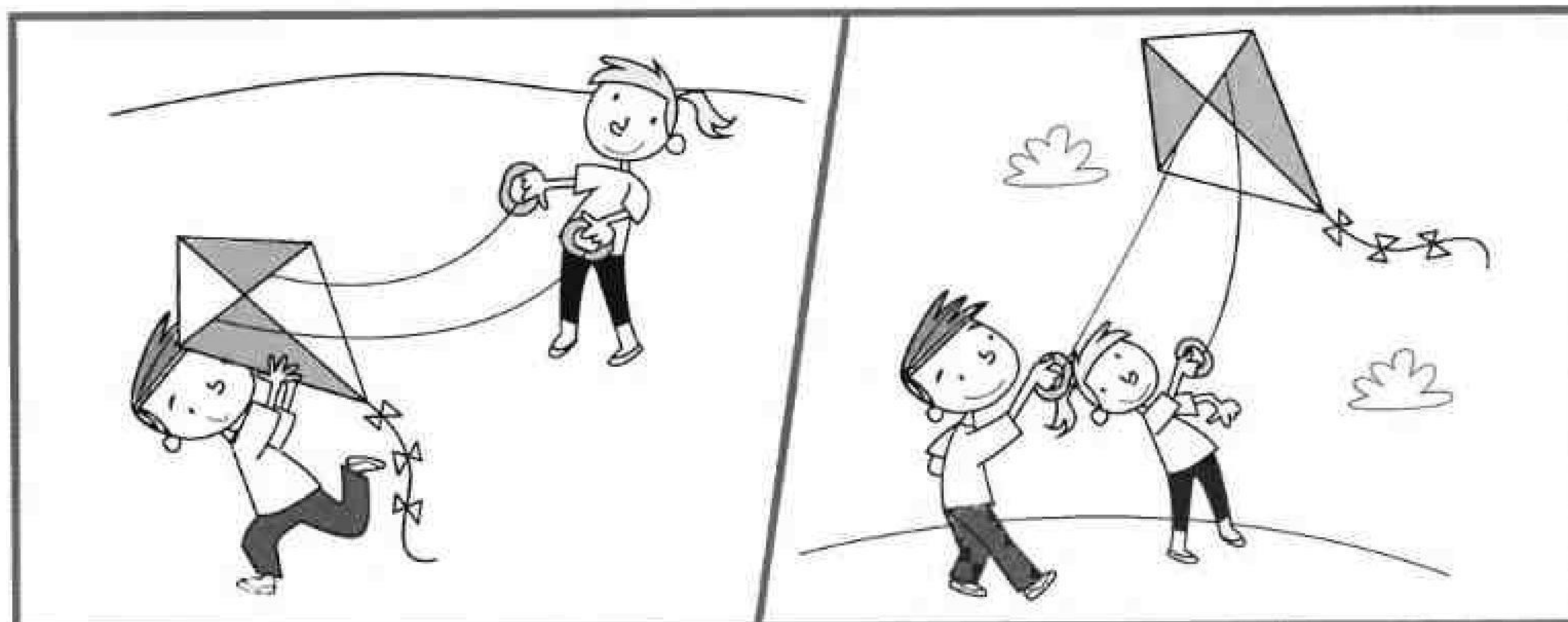

1

Look and draw two ropes and three balls.



1

Think!

Look and circle red

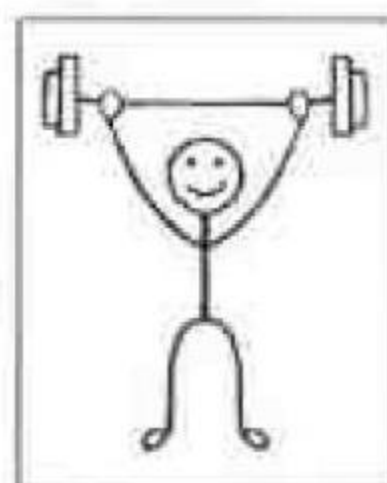

and blue

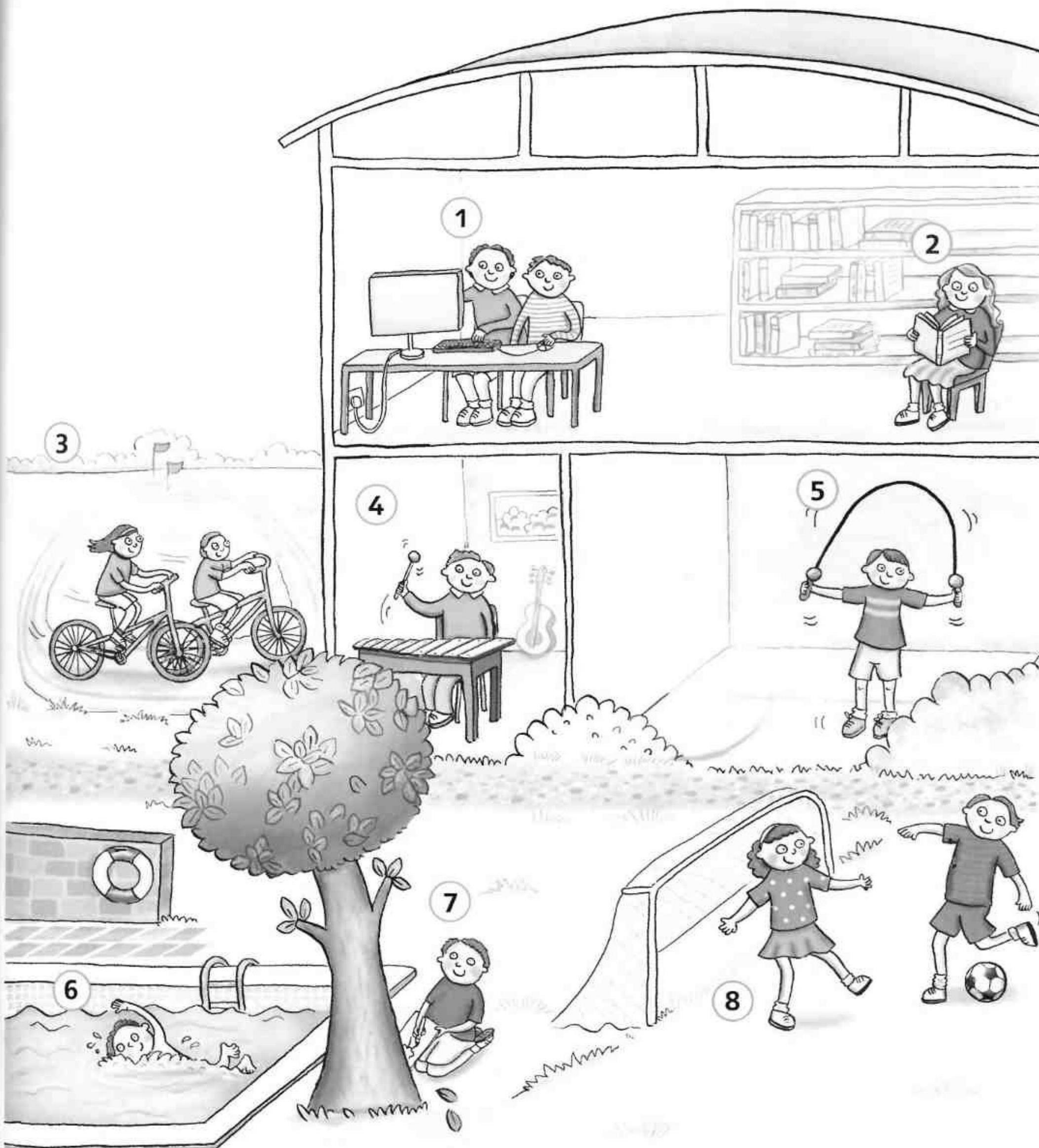
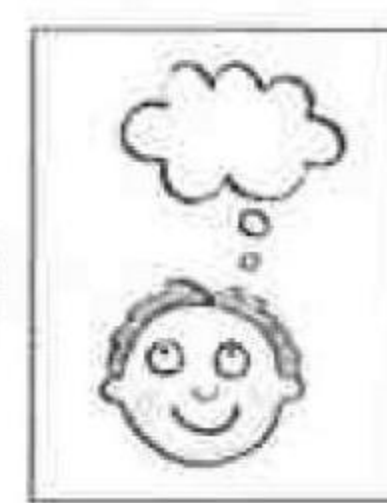

1 Make a paper plane.

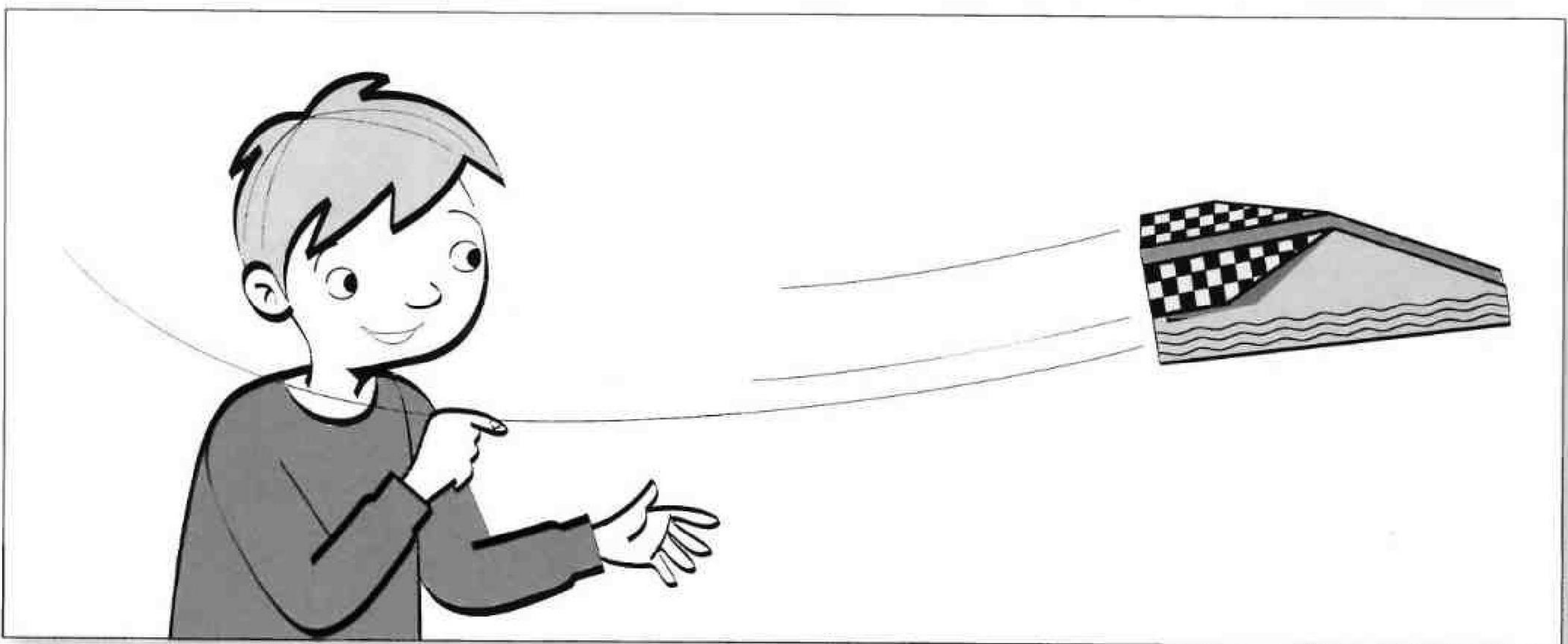
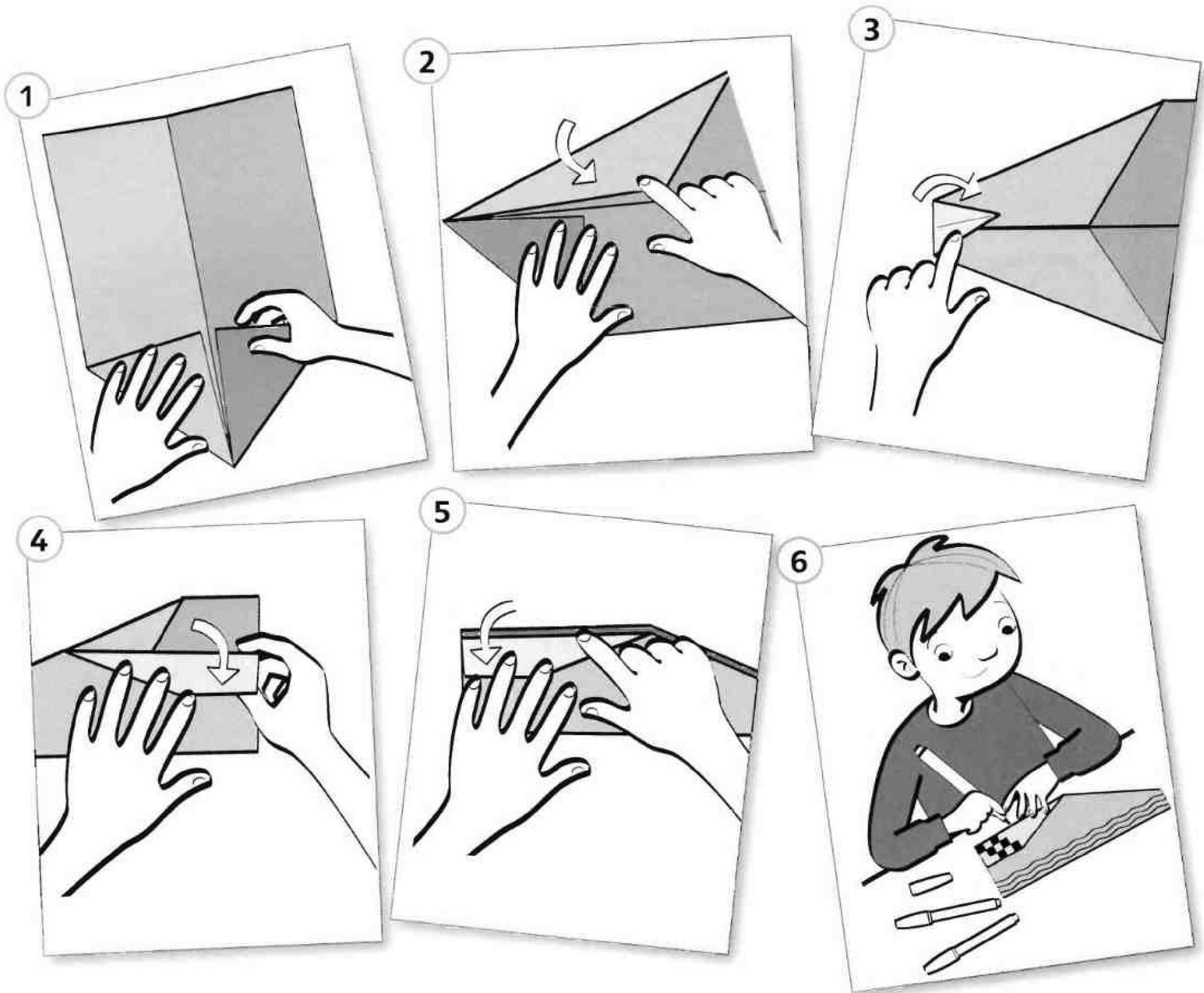

1 Say the words. Colour the circles.

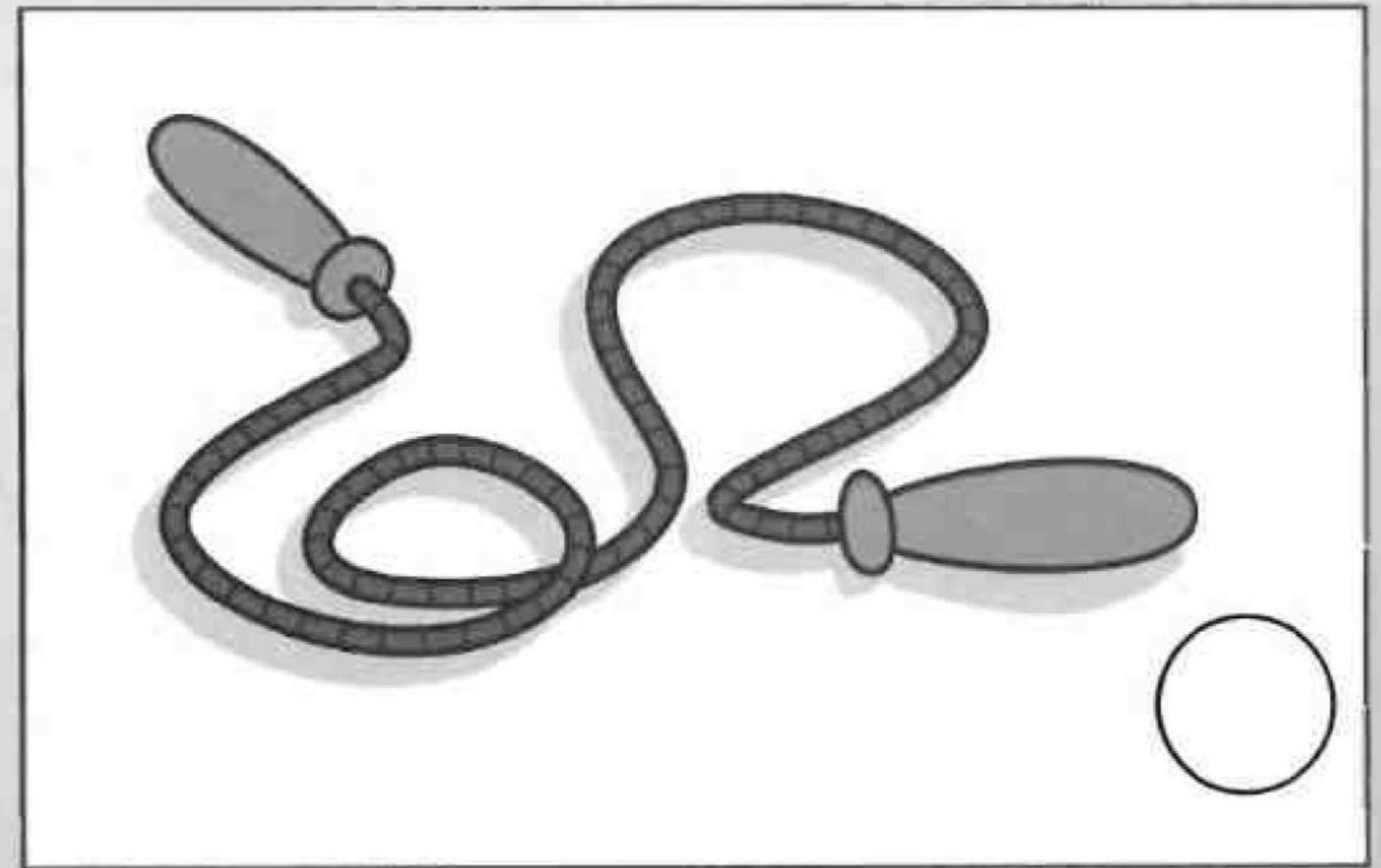
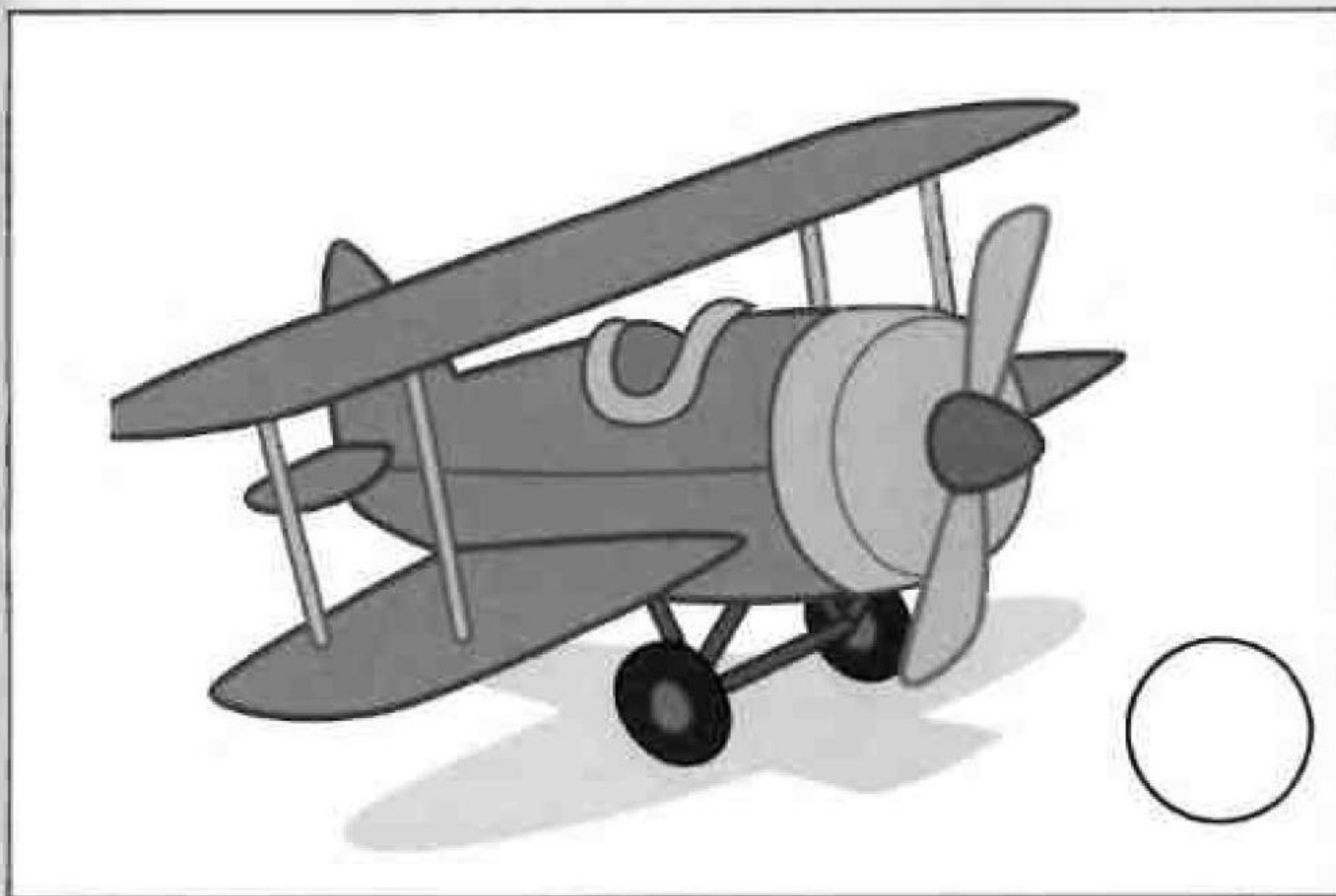
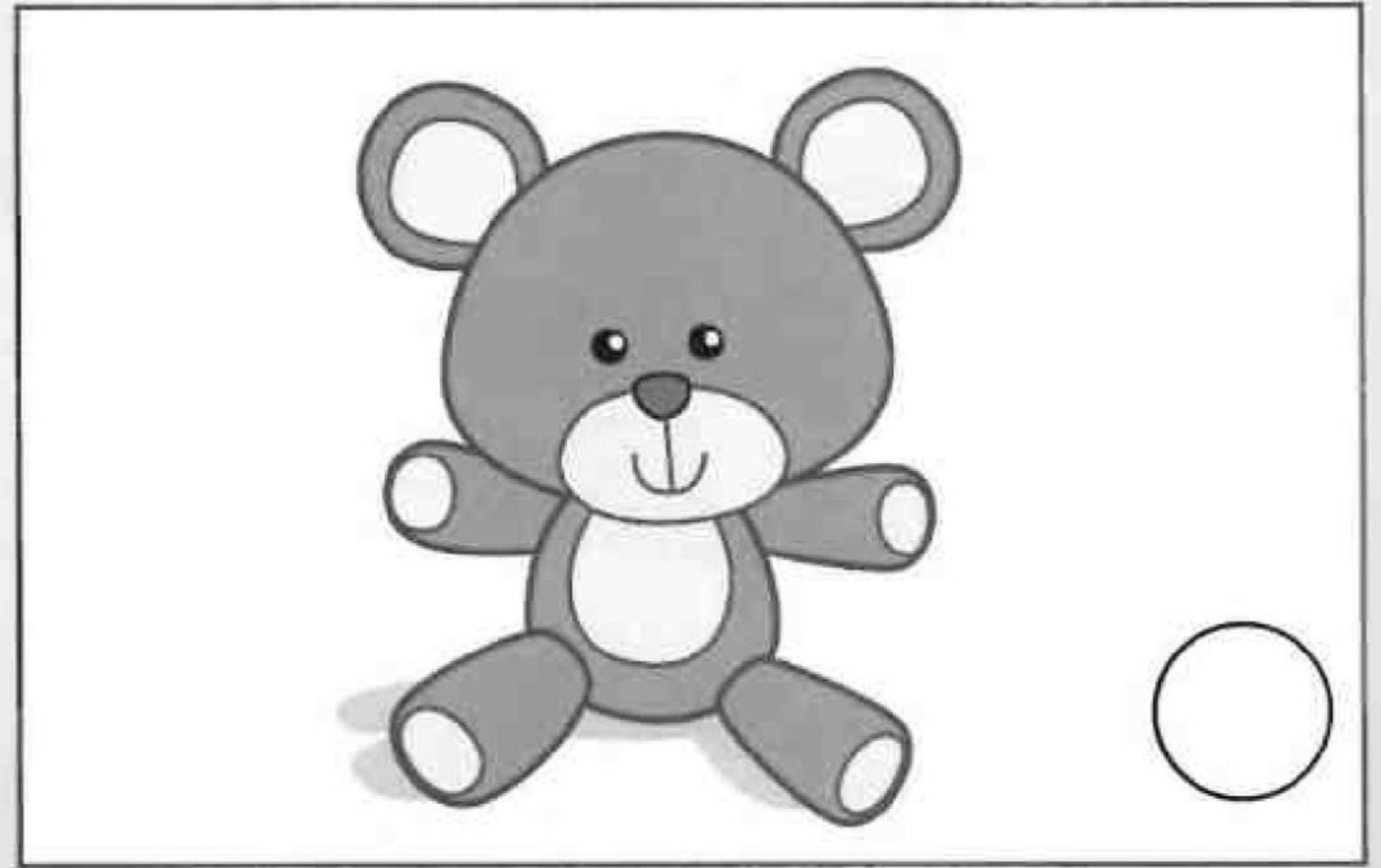
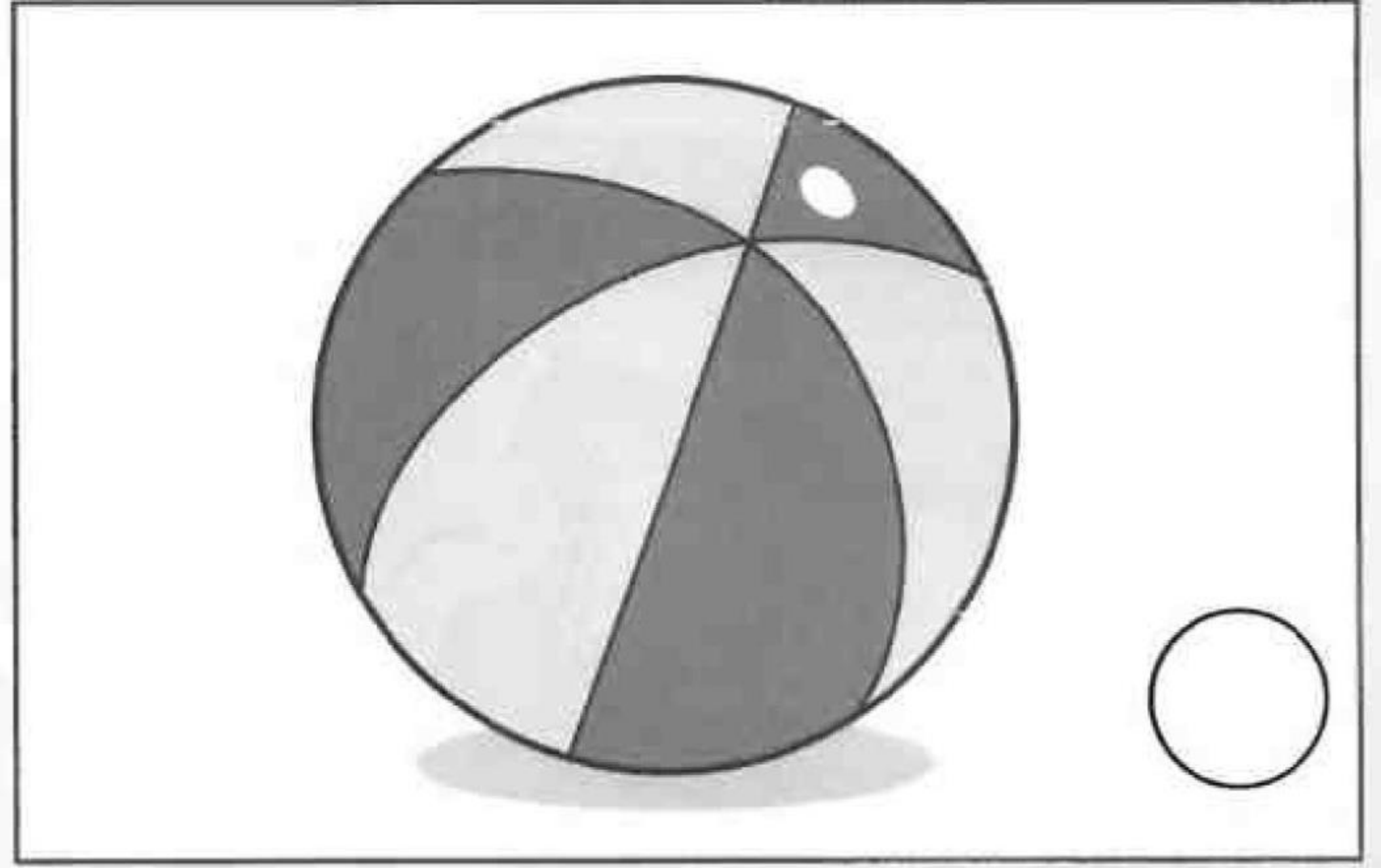
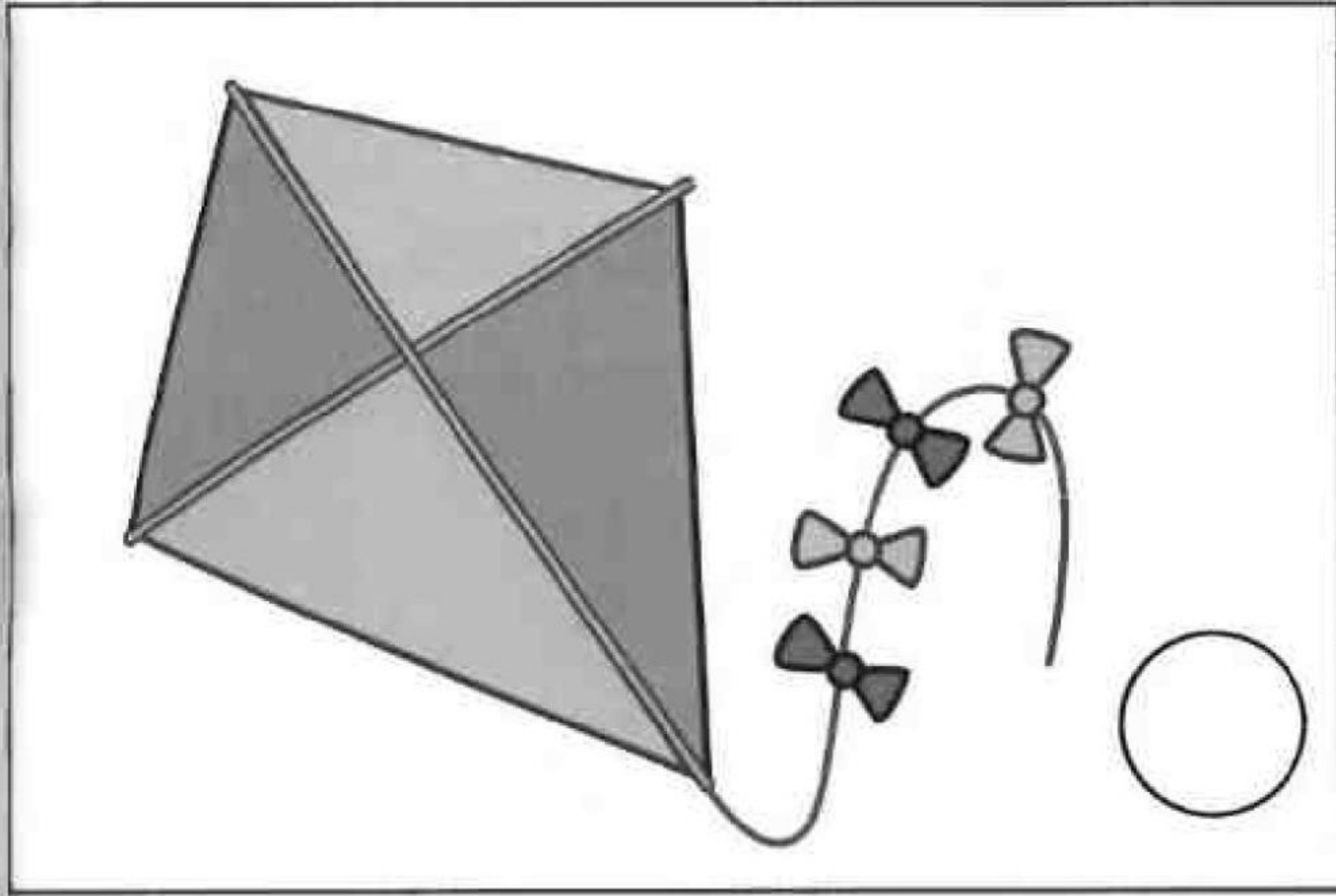

2 Draw faces. 😊 😐 ☹️

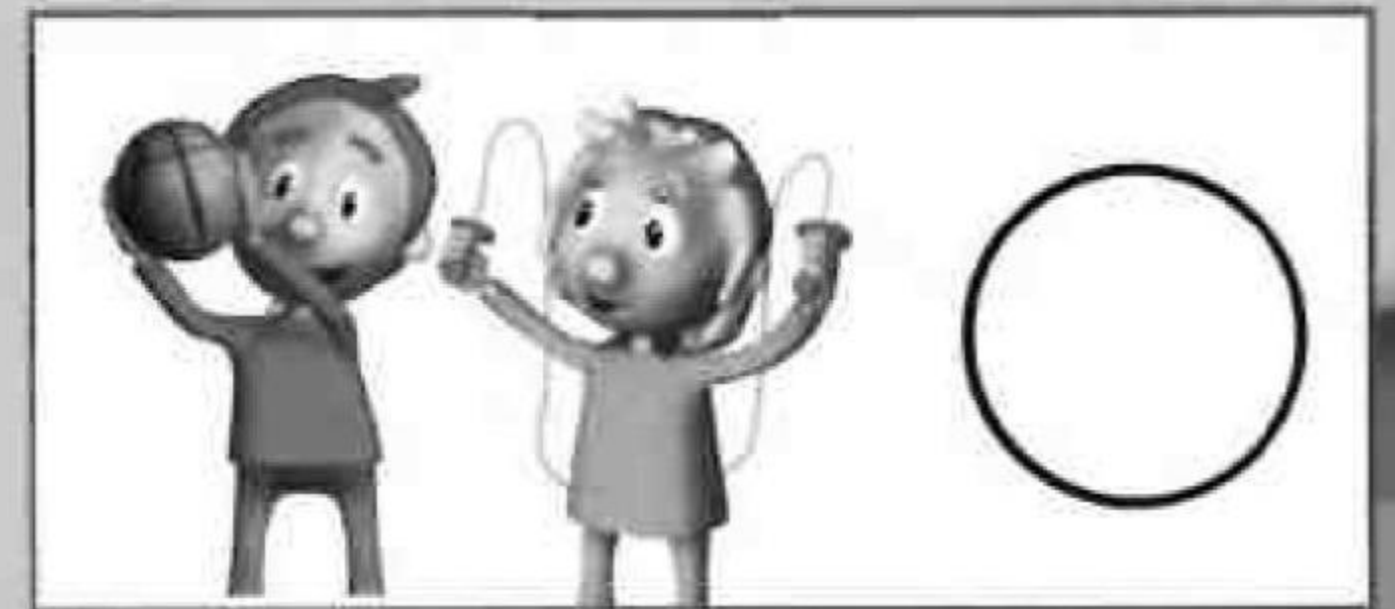
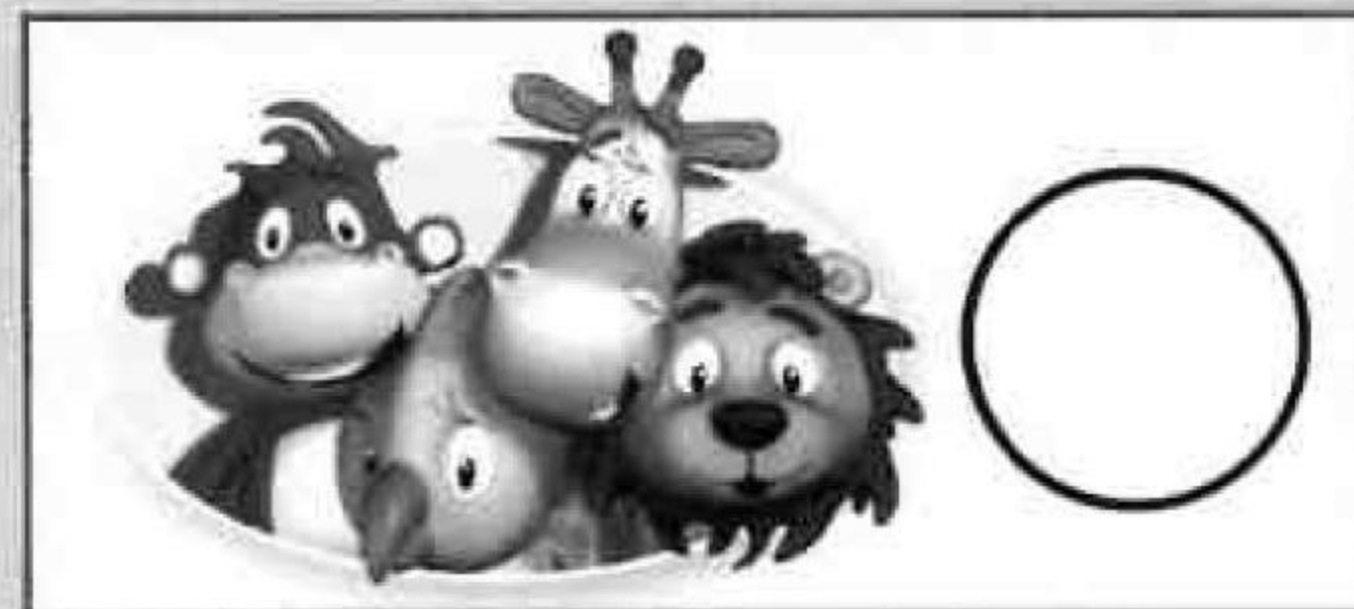

5

My house

1 Think! Match, colour and make sentences.

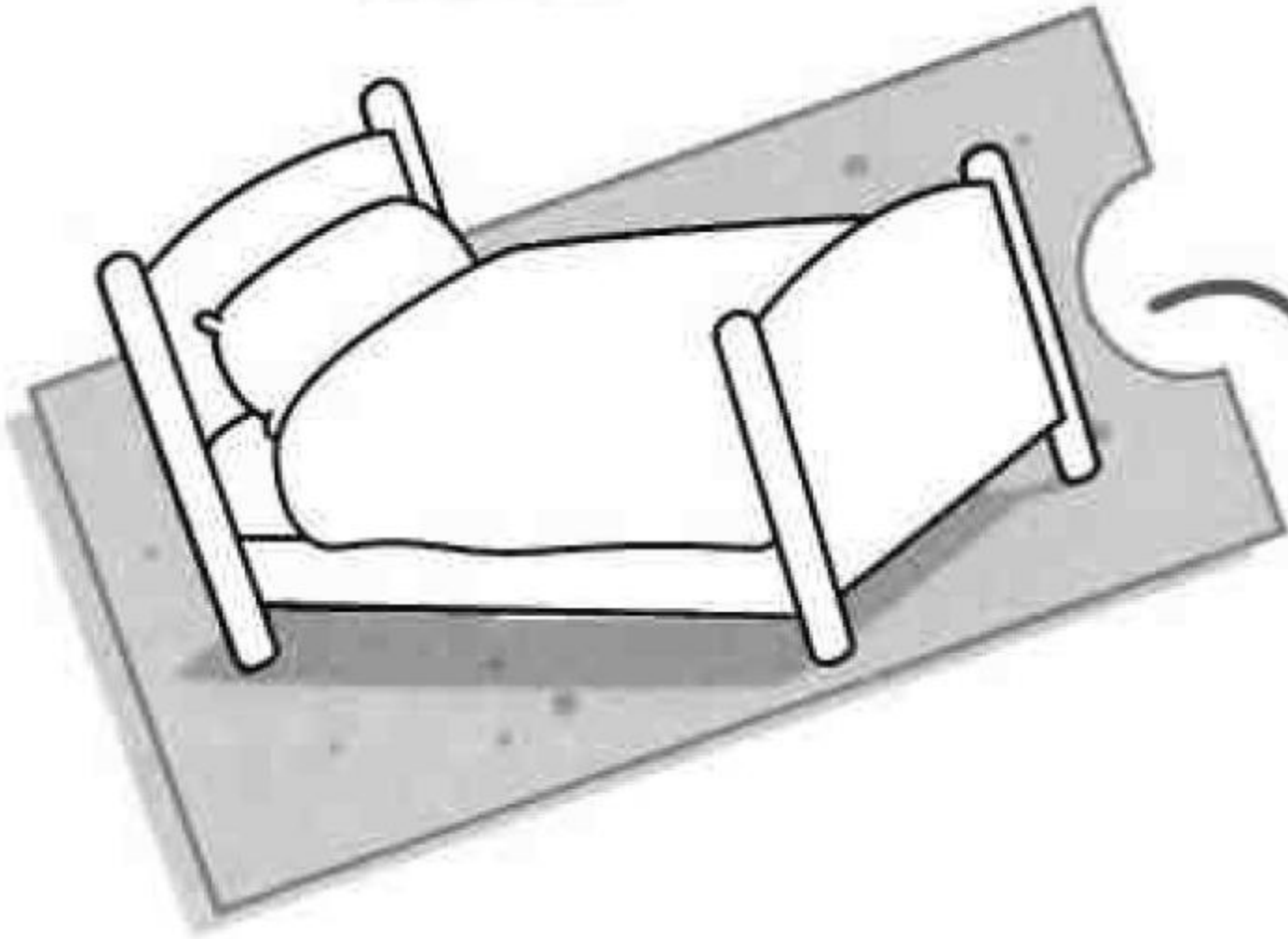

bath

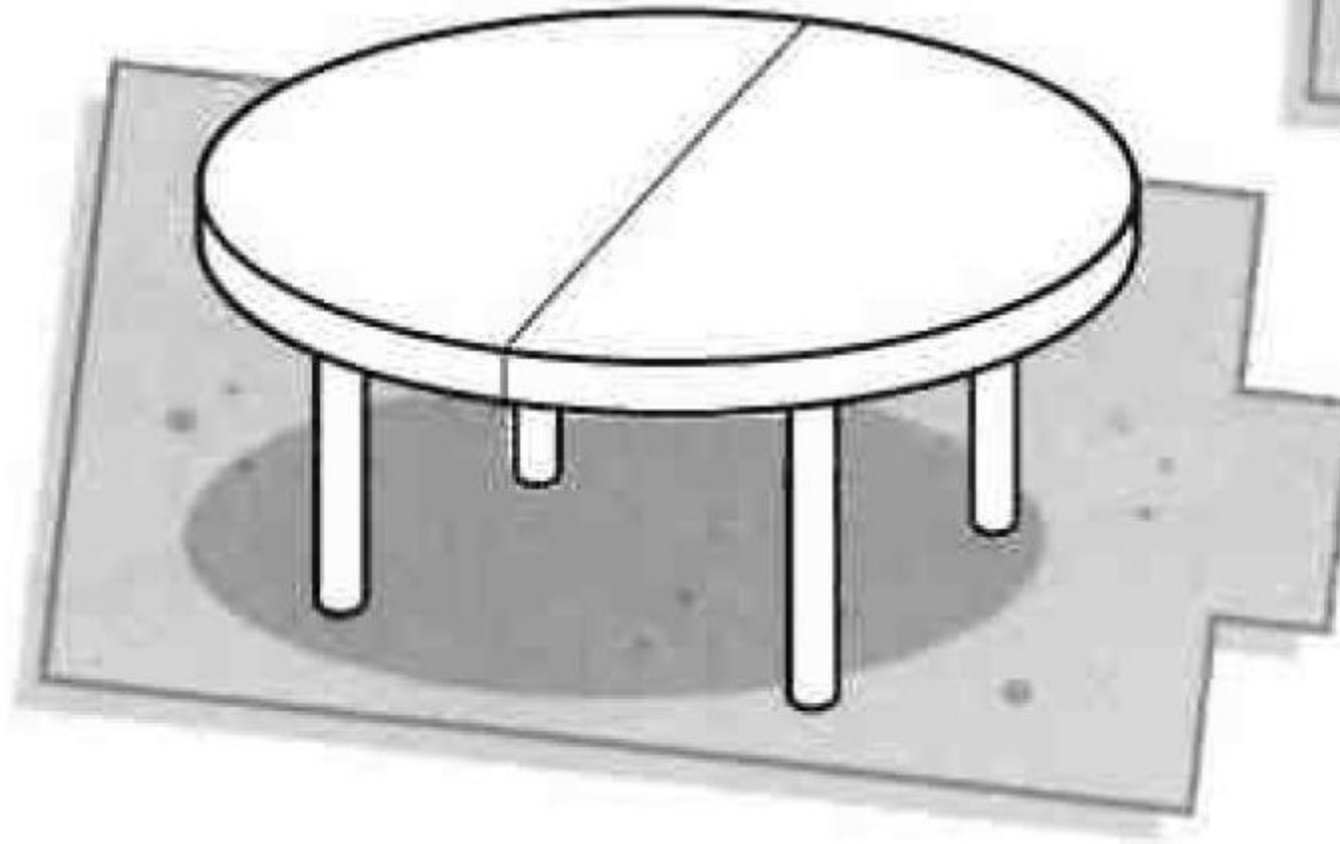

sofa

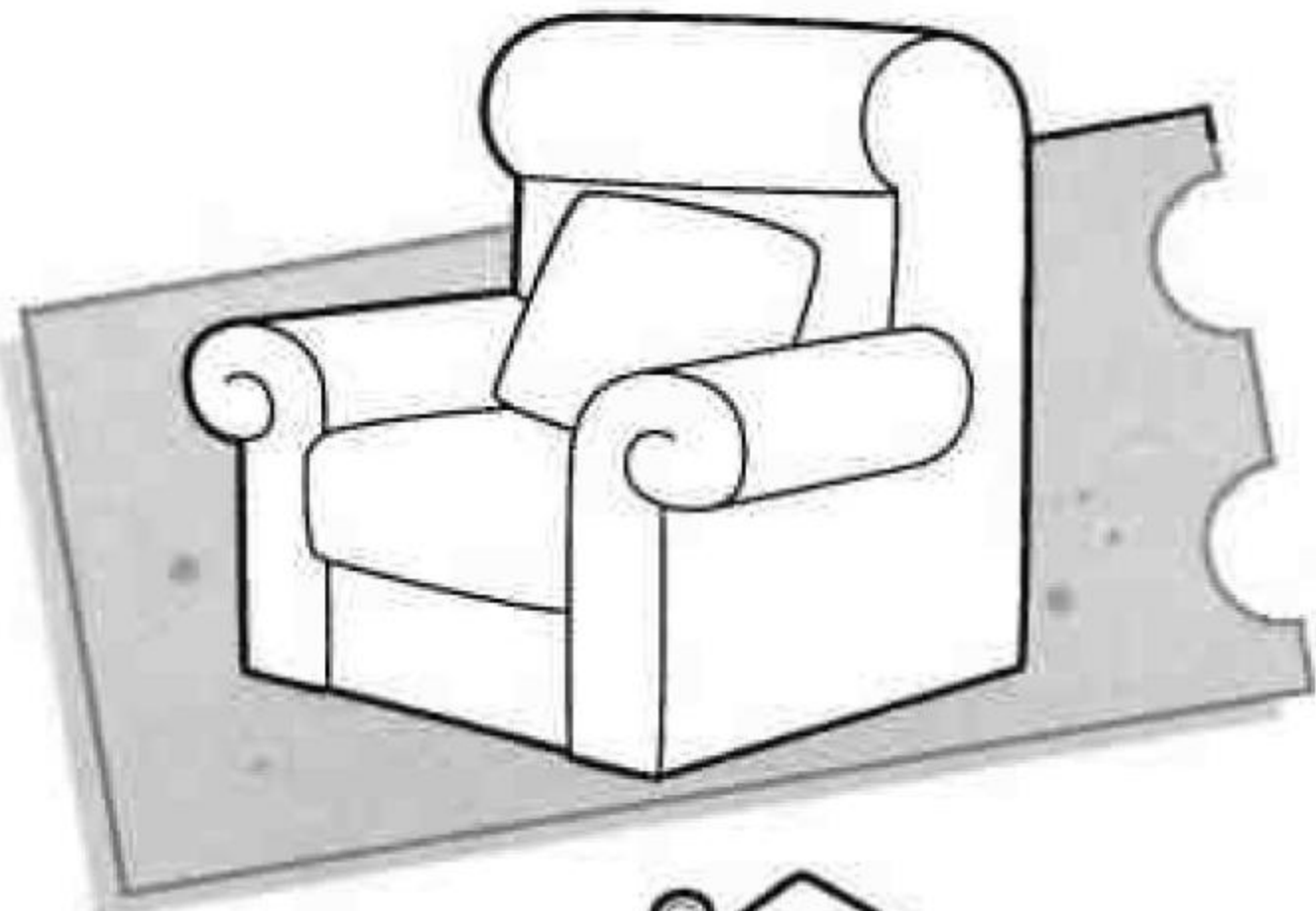

cupboard

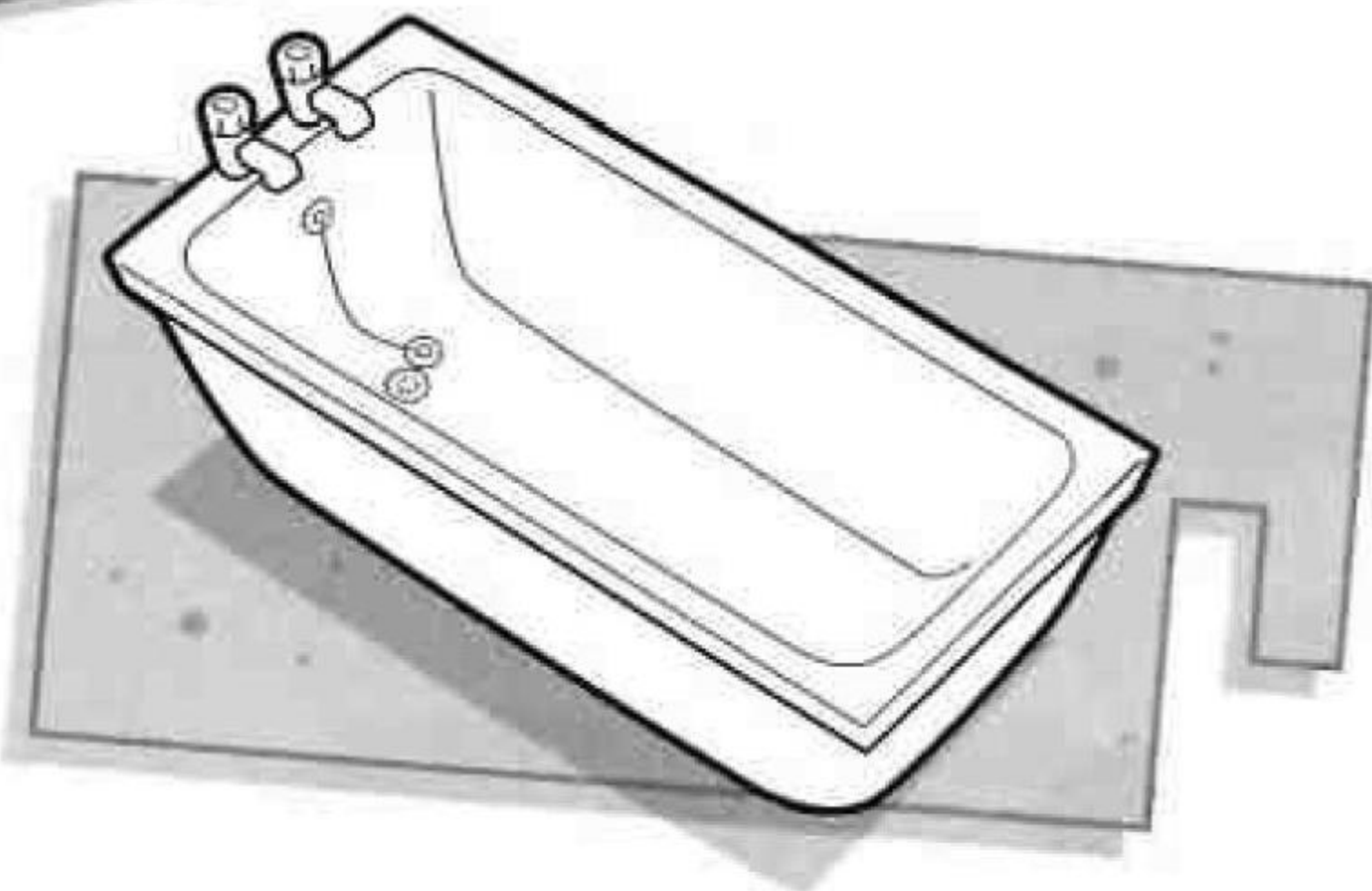

armchair

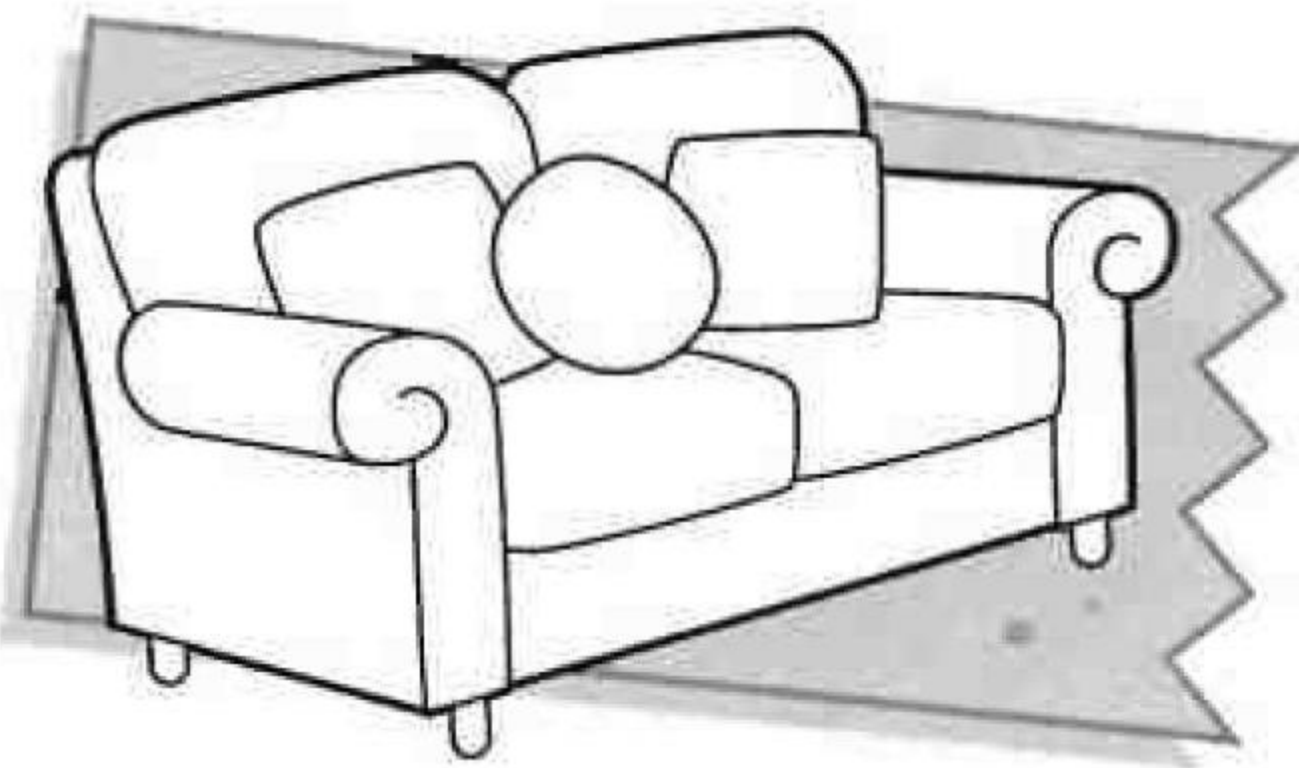

bed

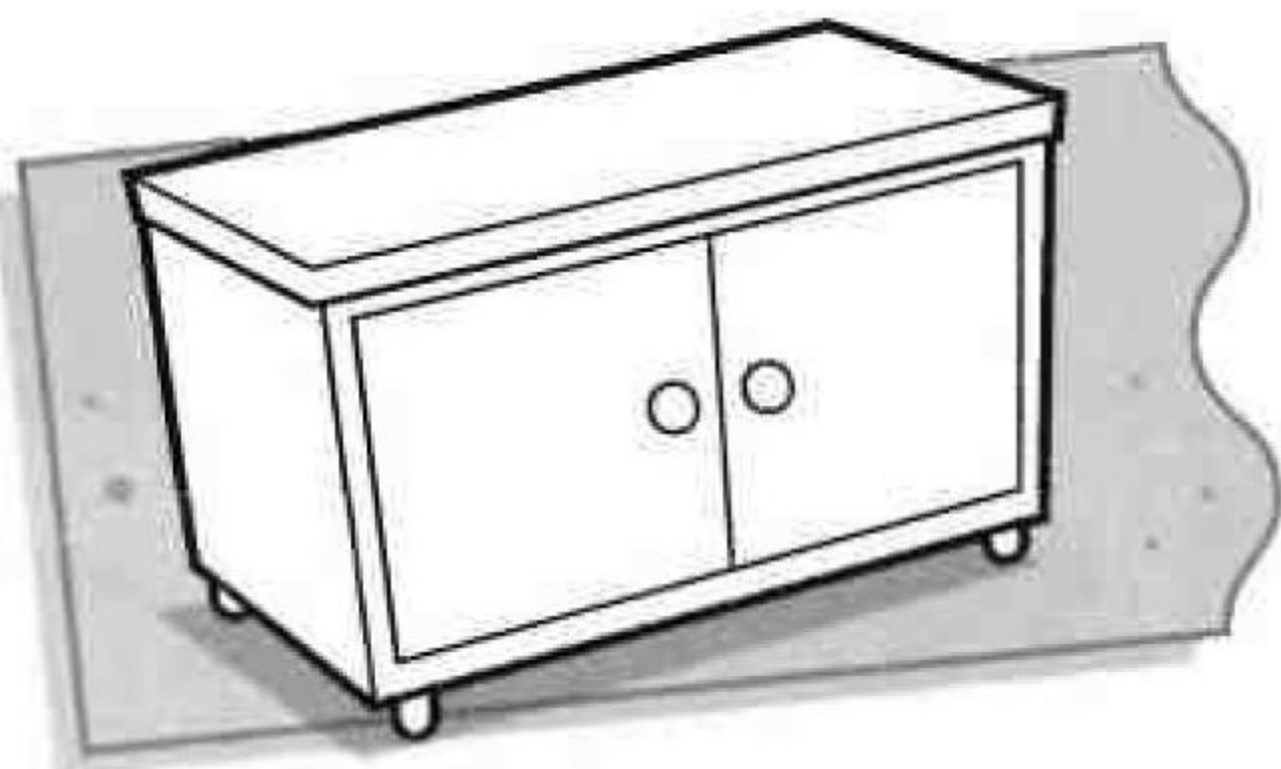

table

1 CD2 05 Listen and circle.

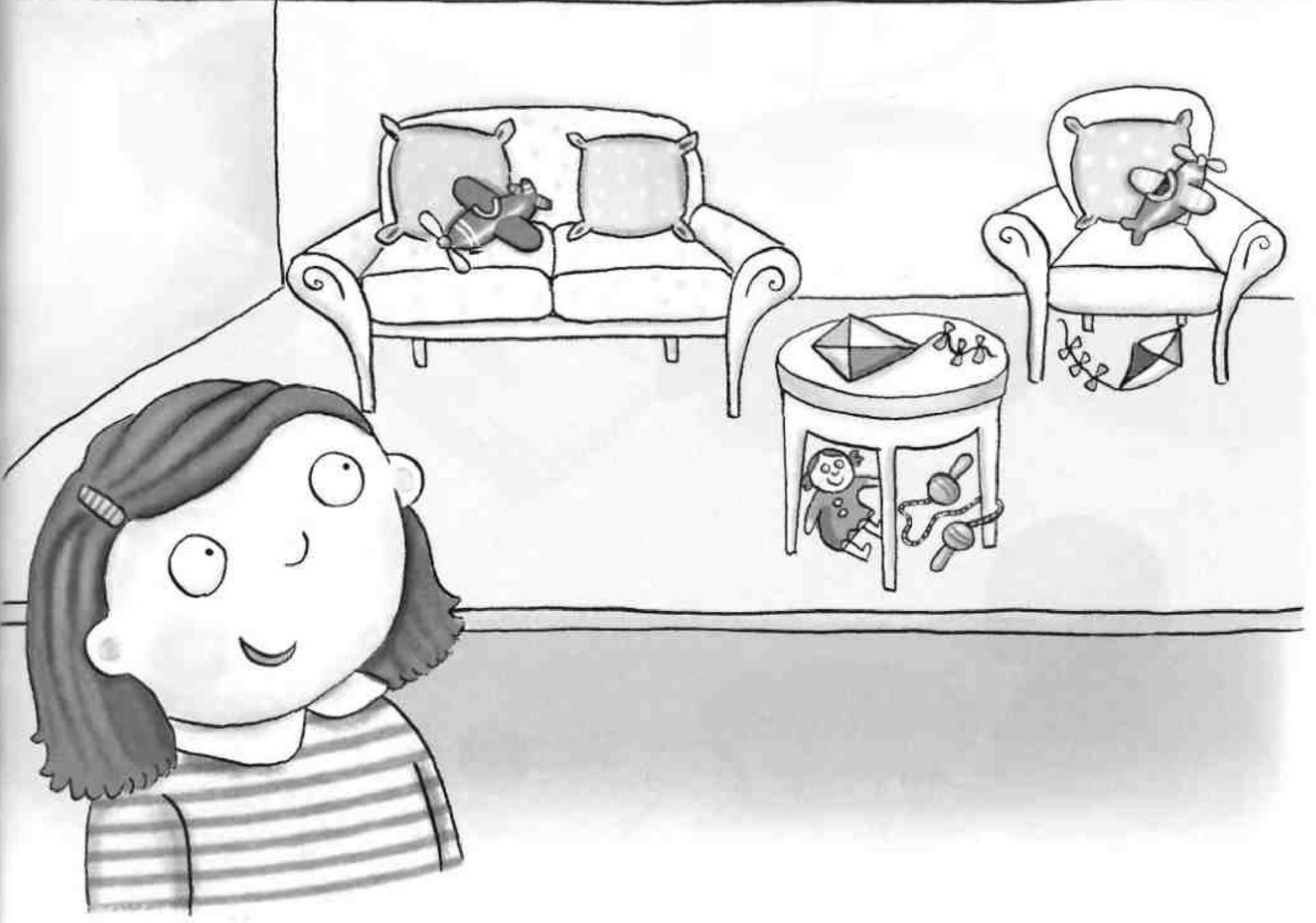
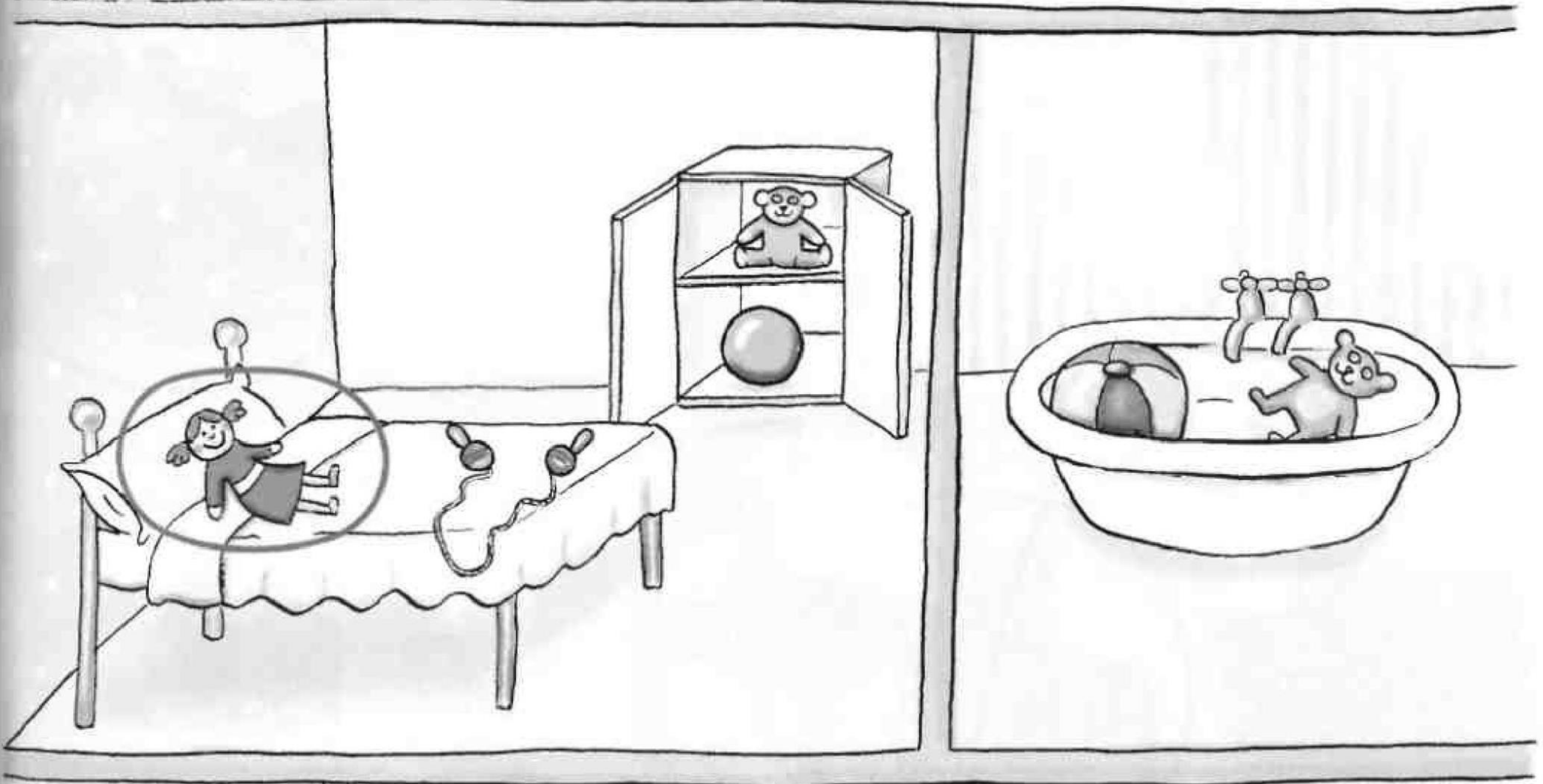

1

Draw lines.

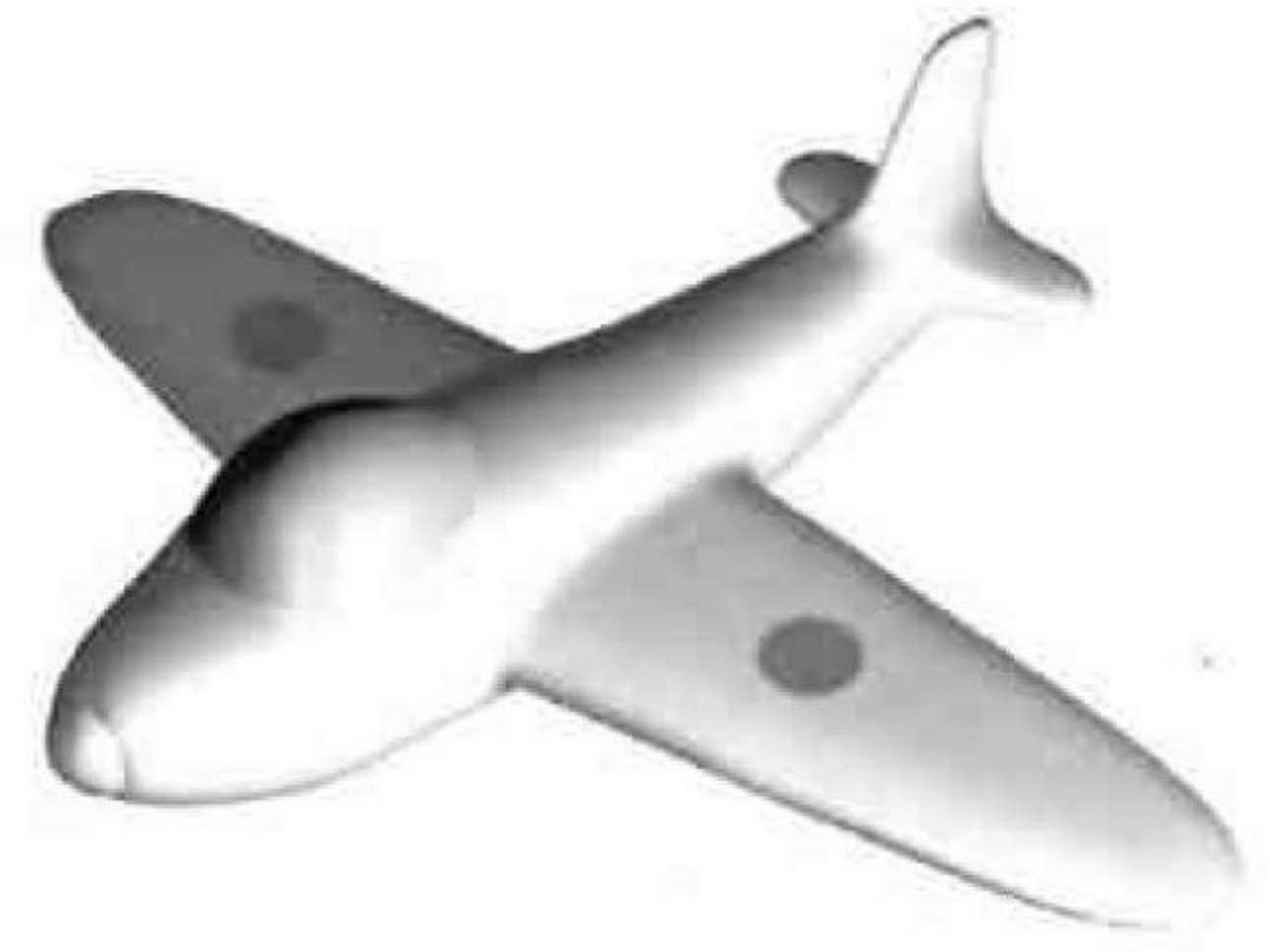
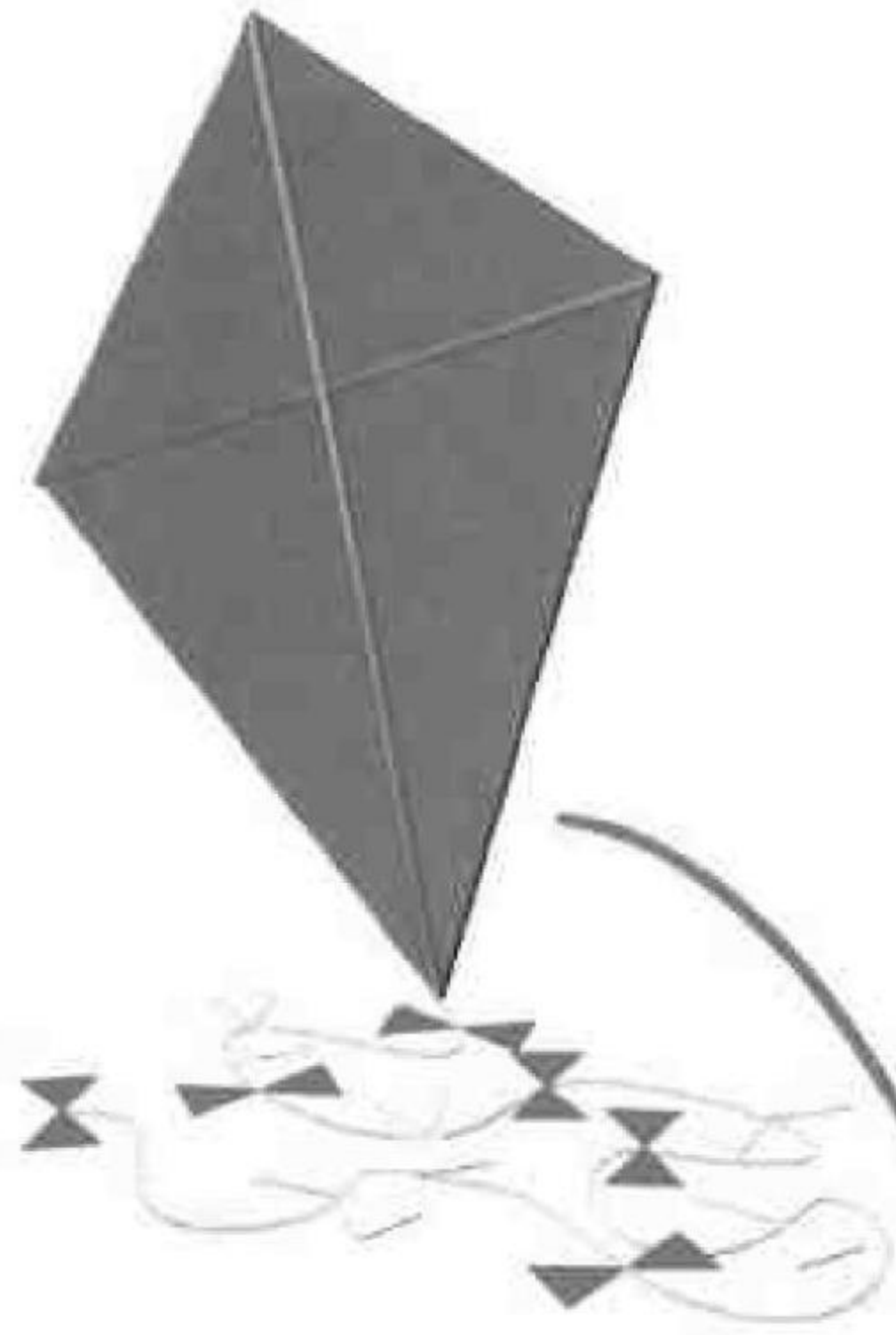

1 Find pairs and circle.

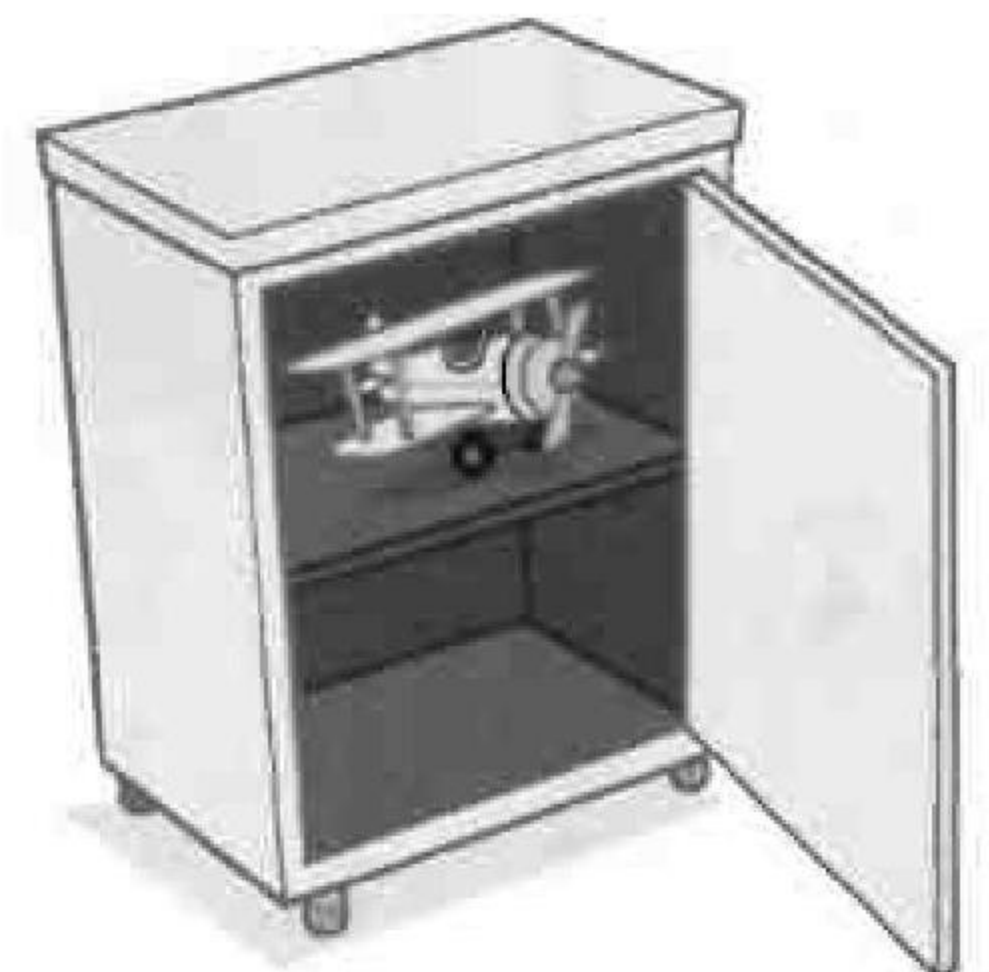
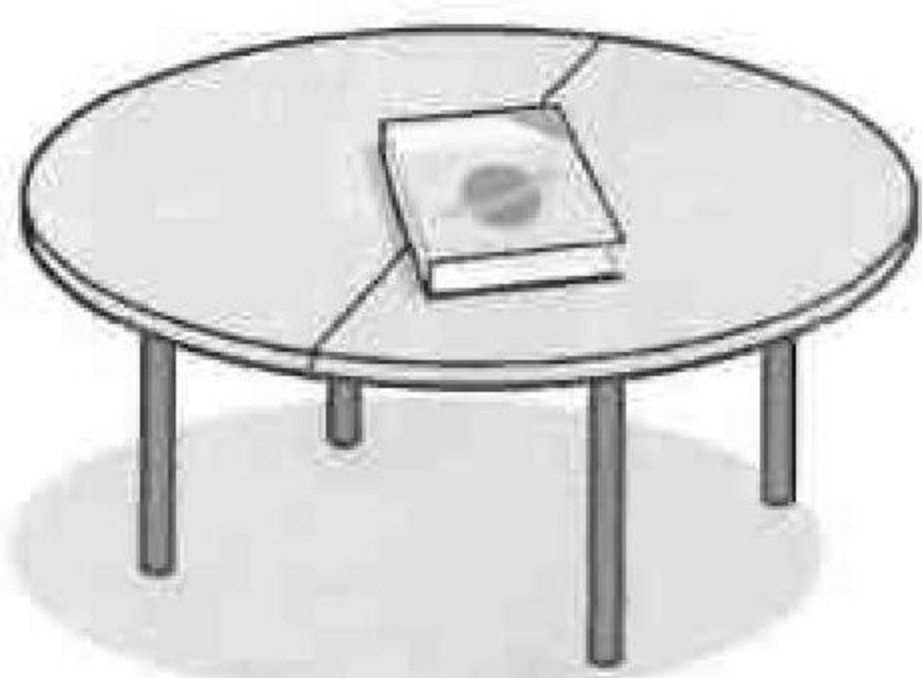
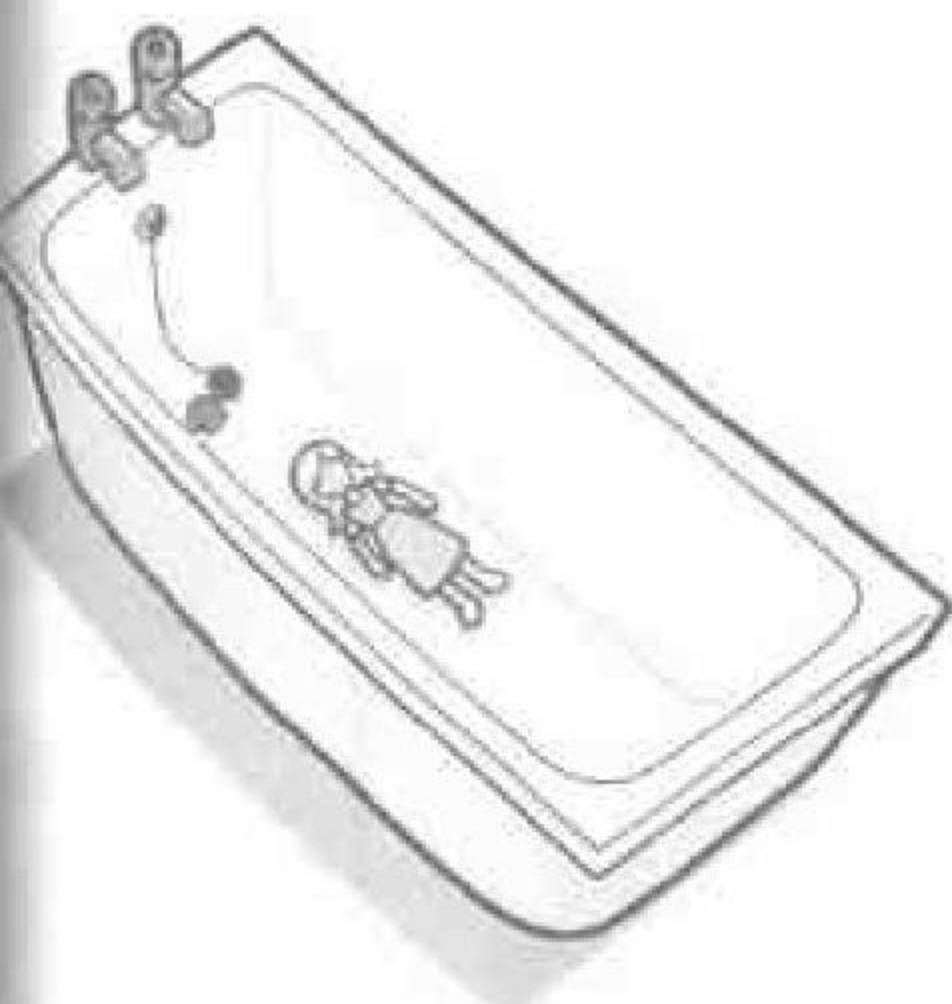
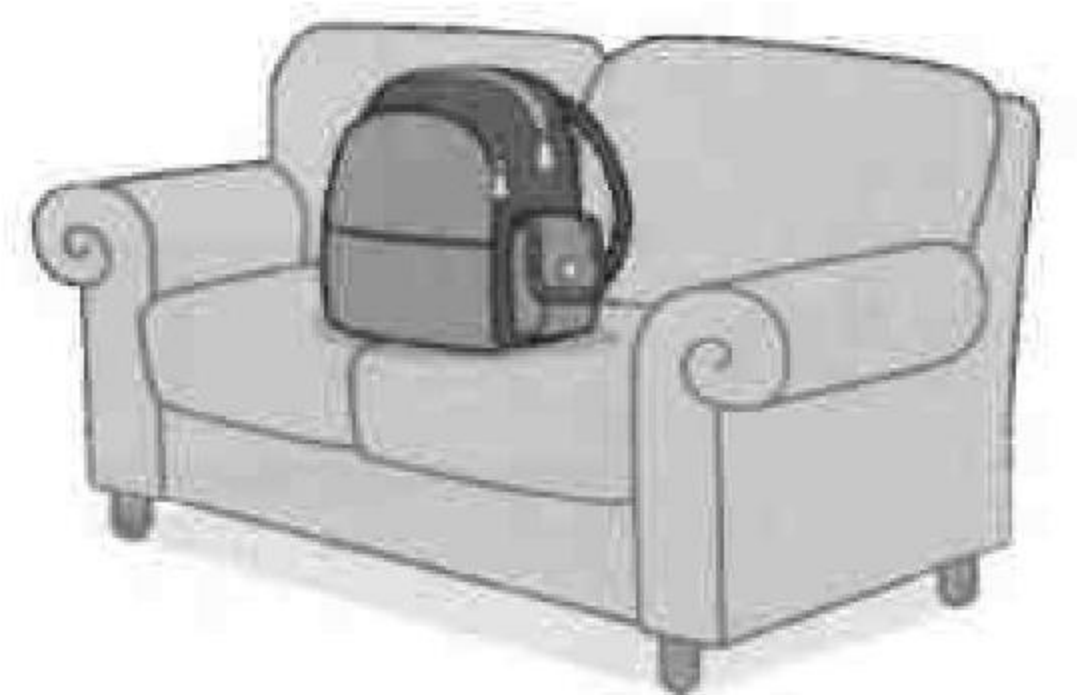
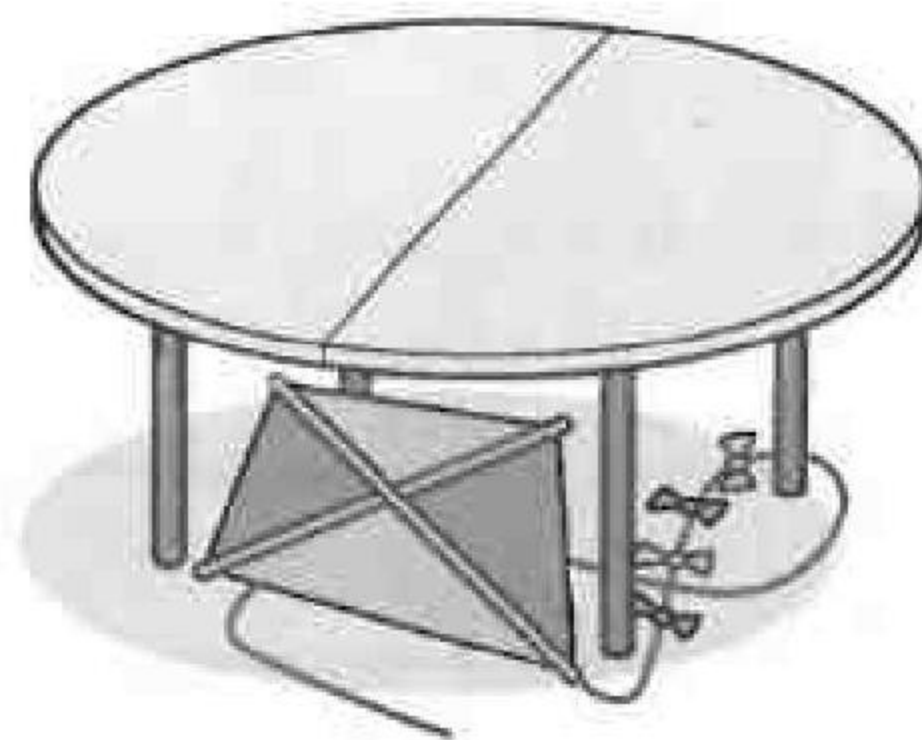
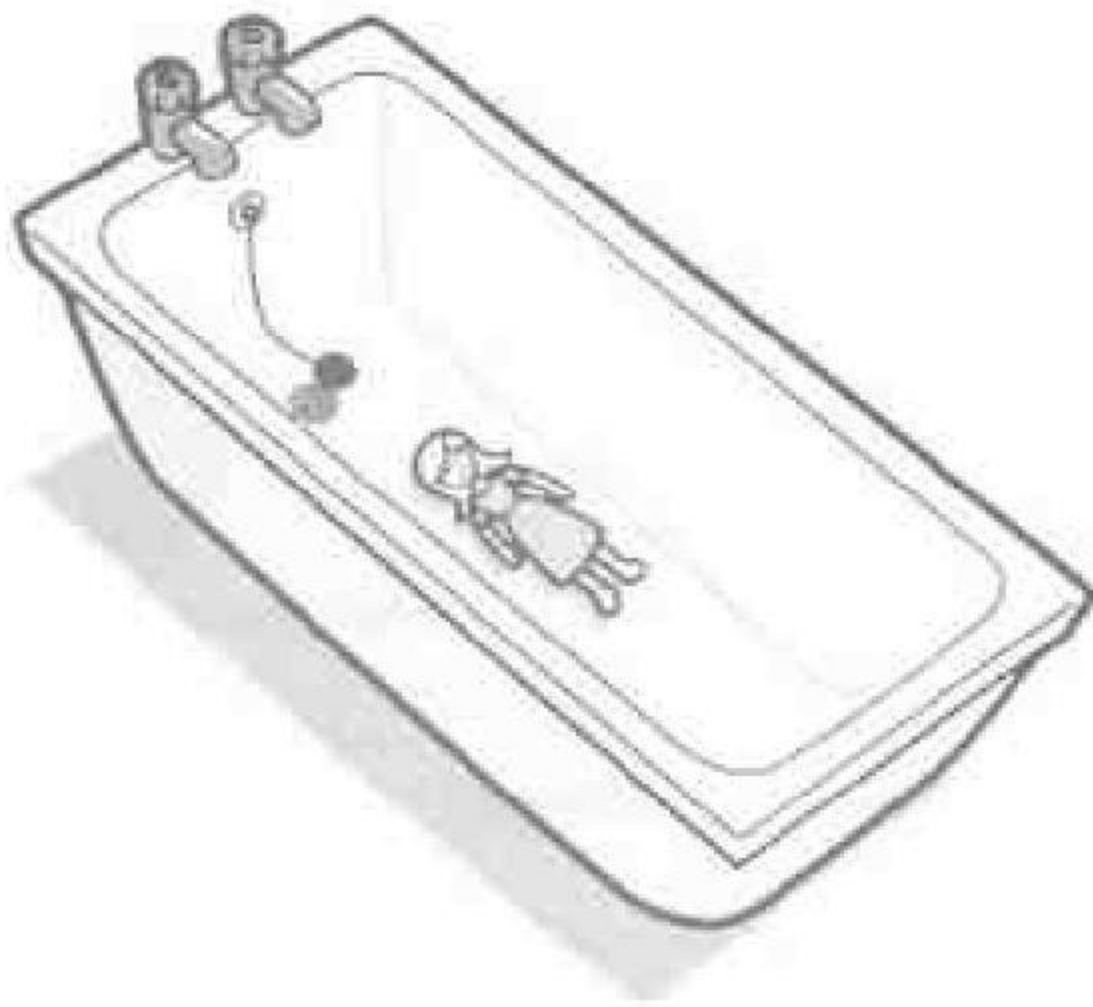
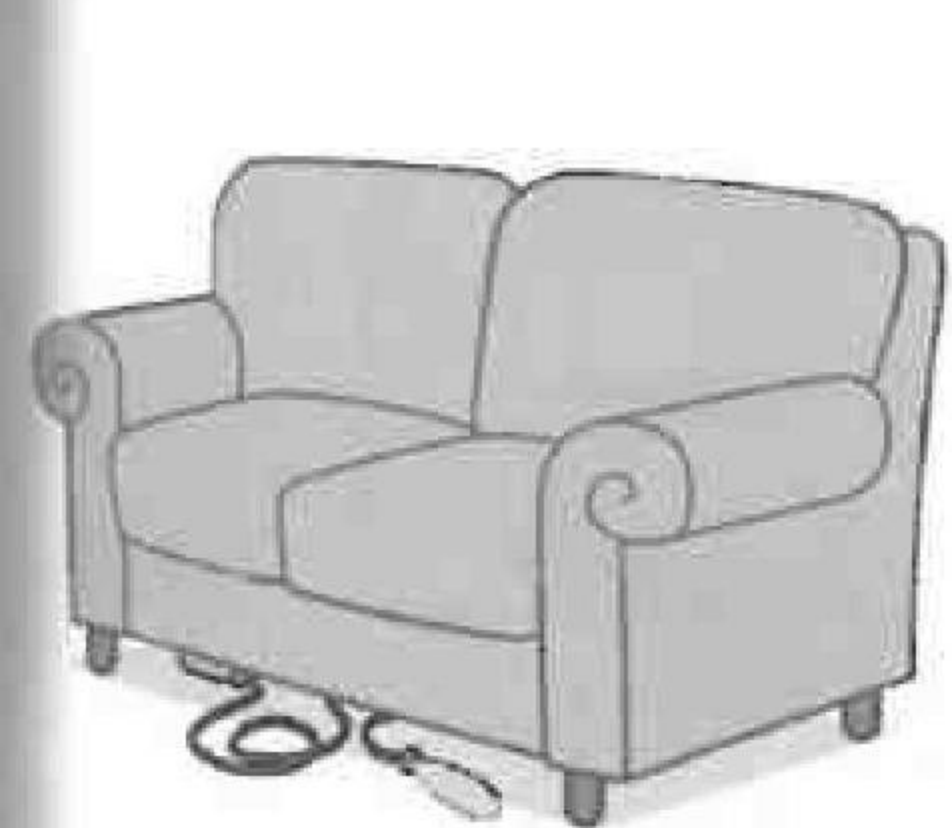
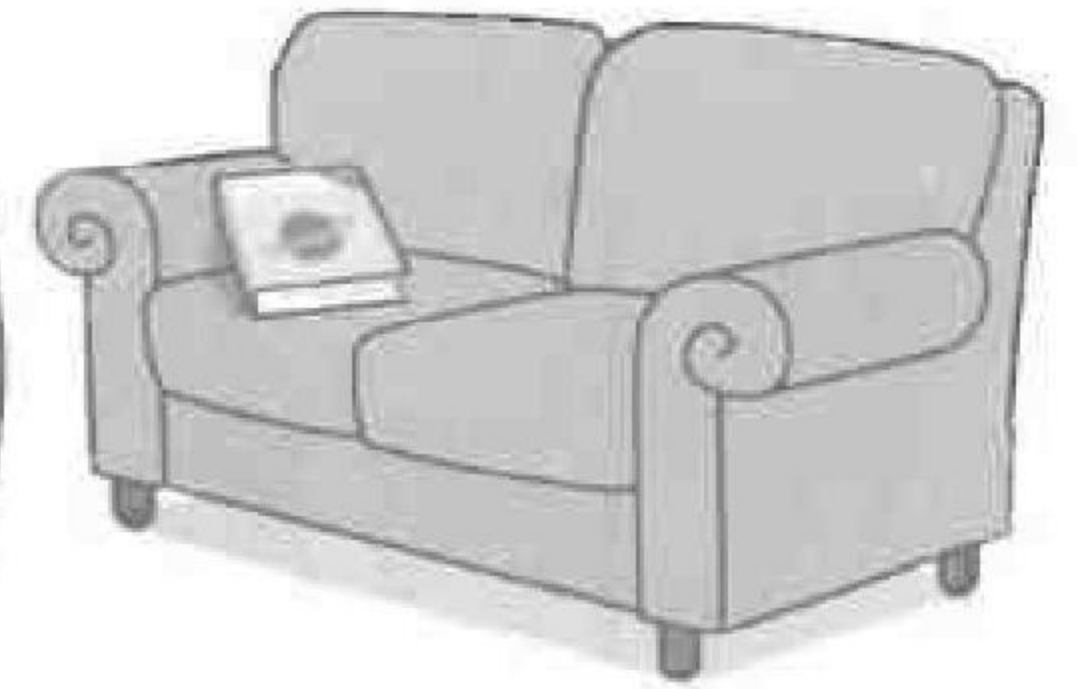
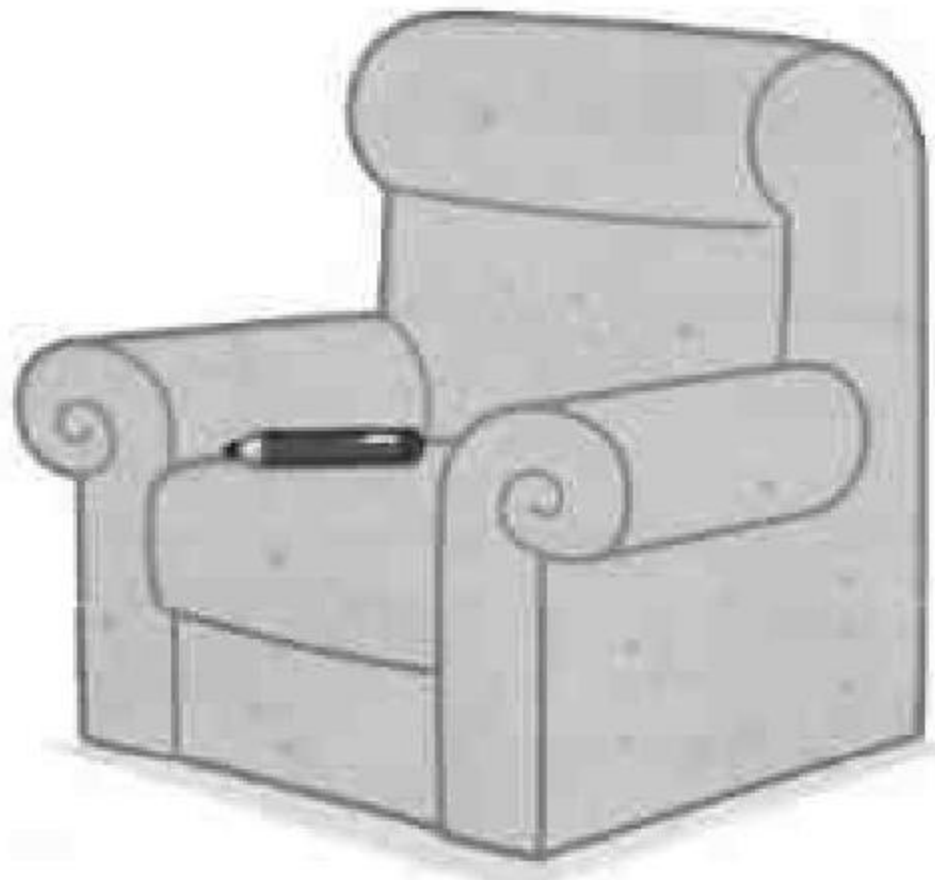
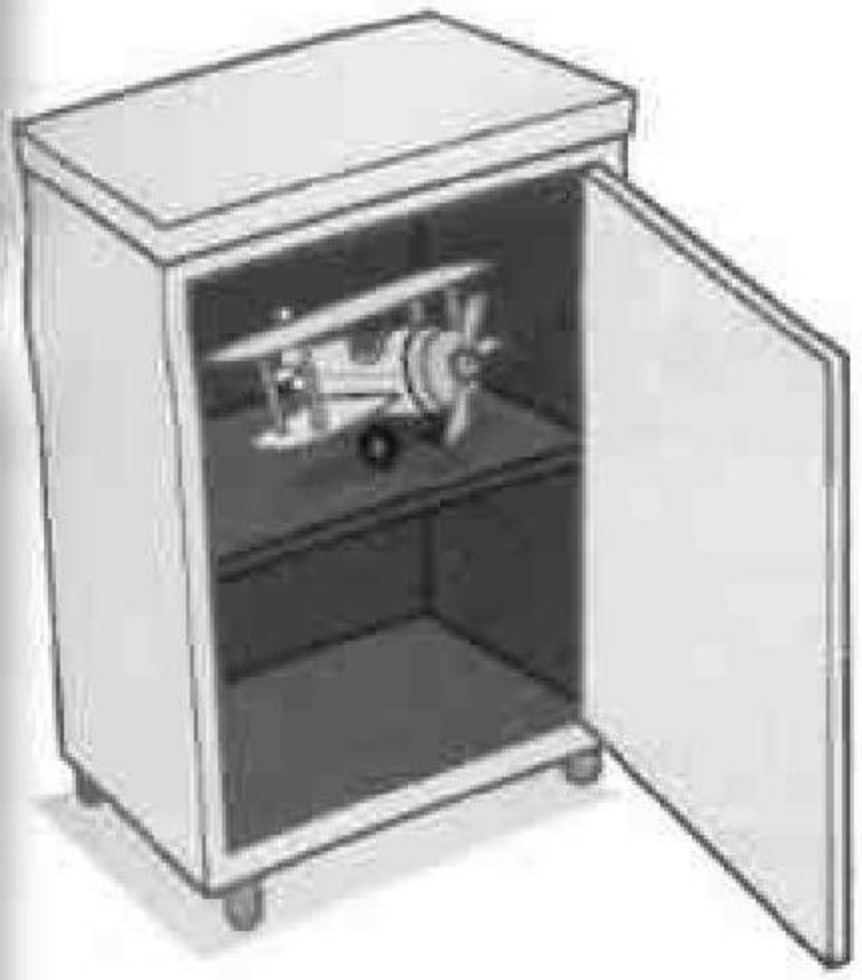
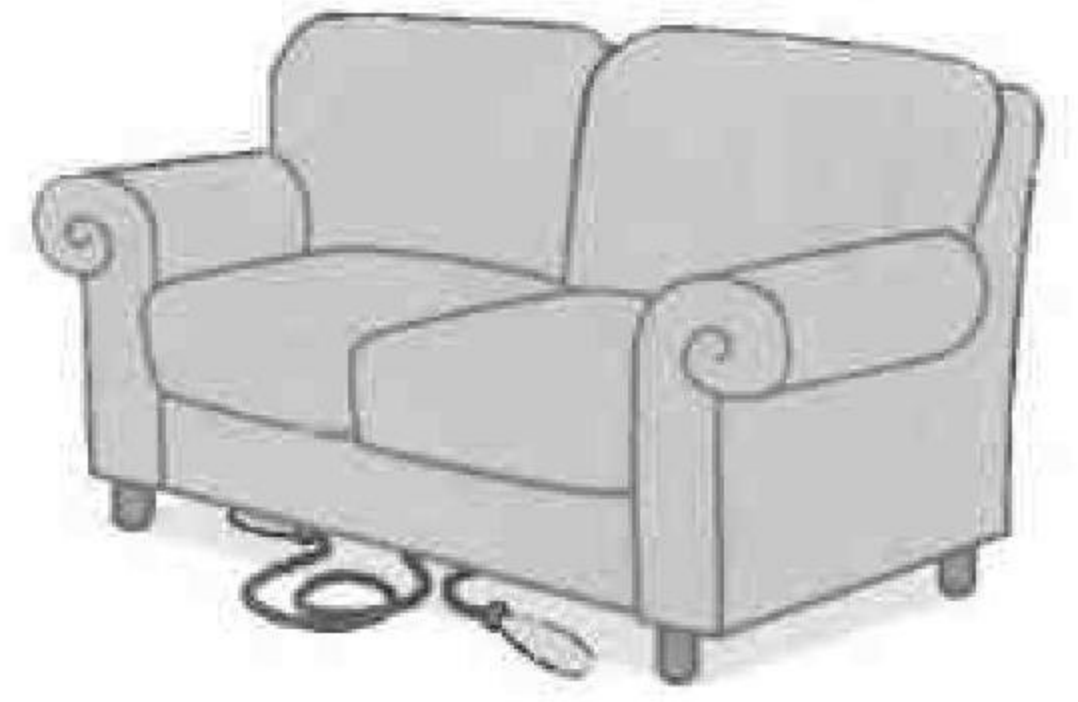
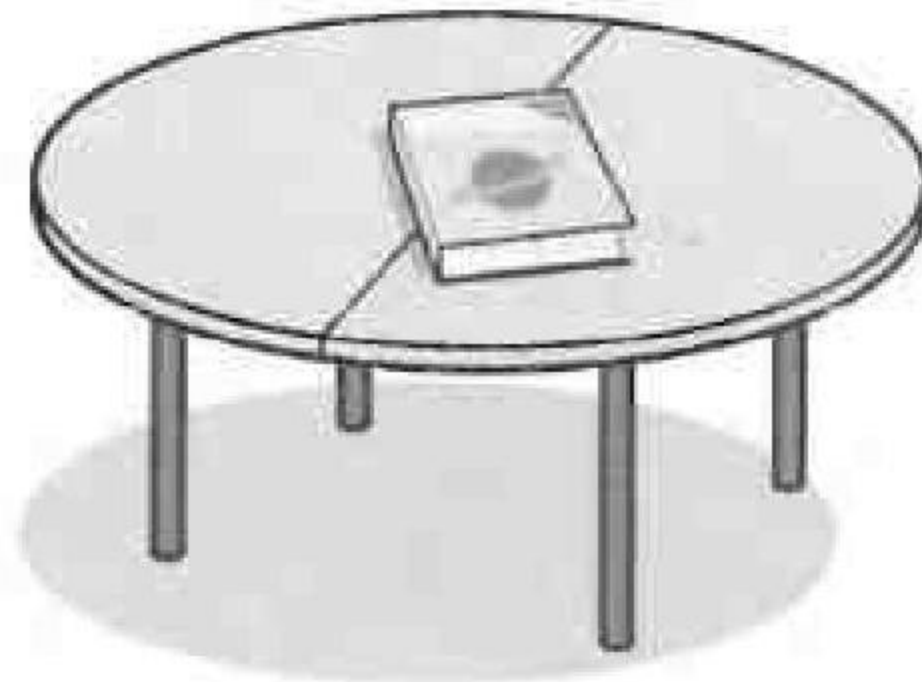
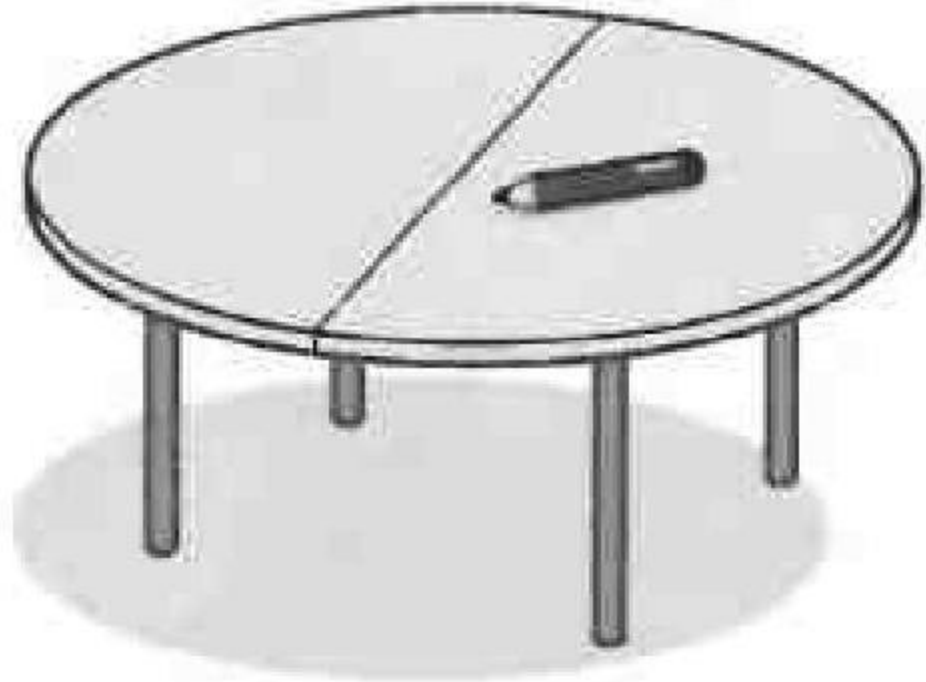

Listen and trace.

1

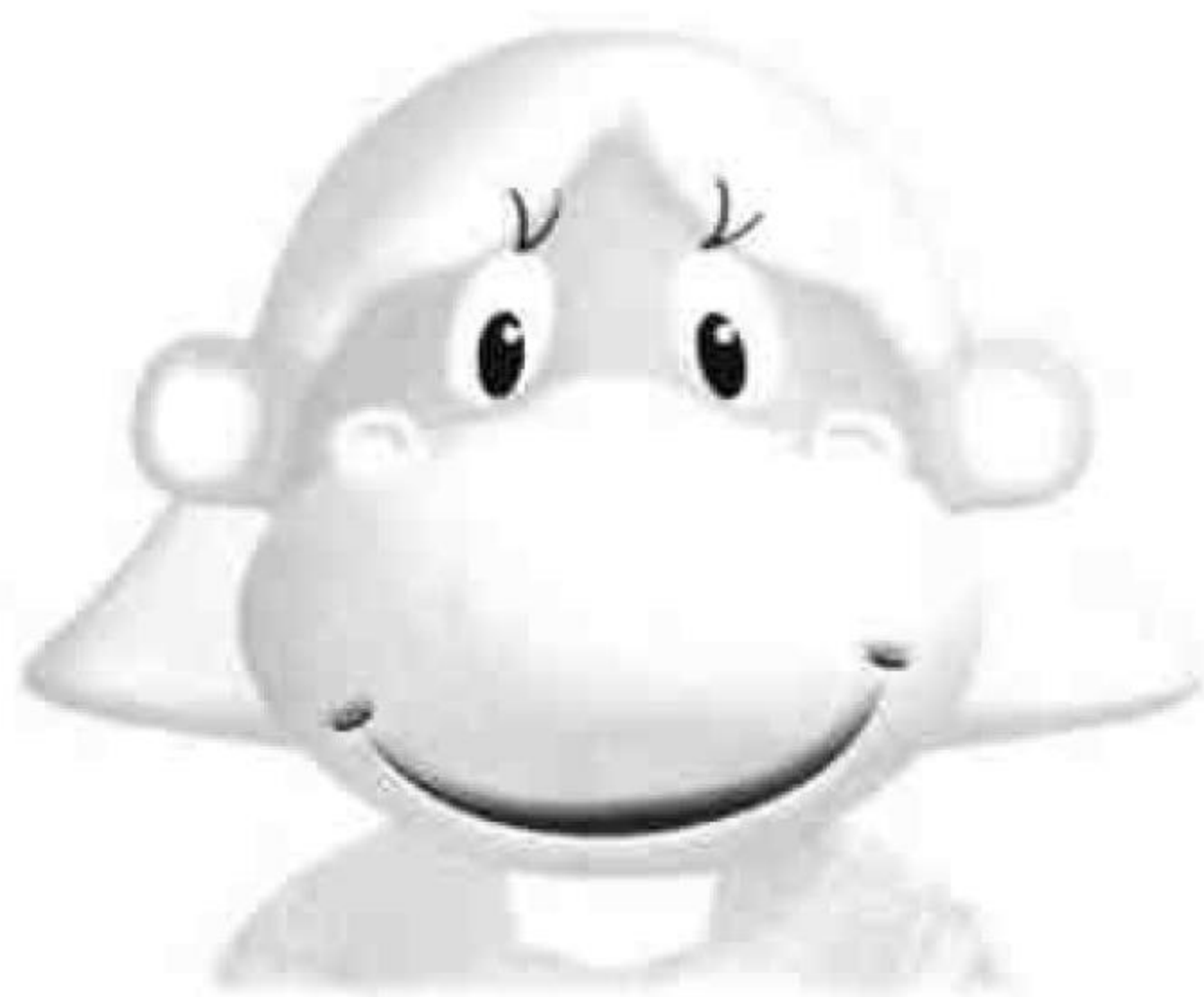

2

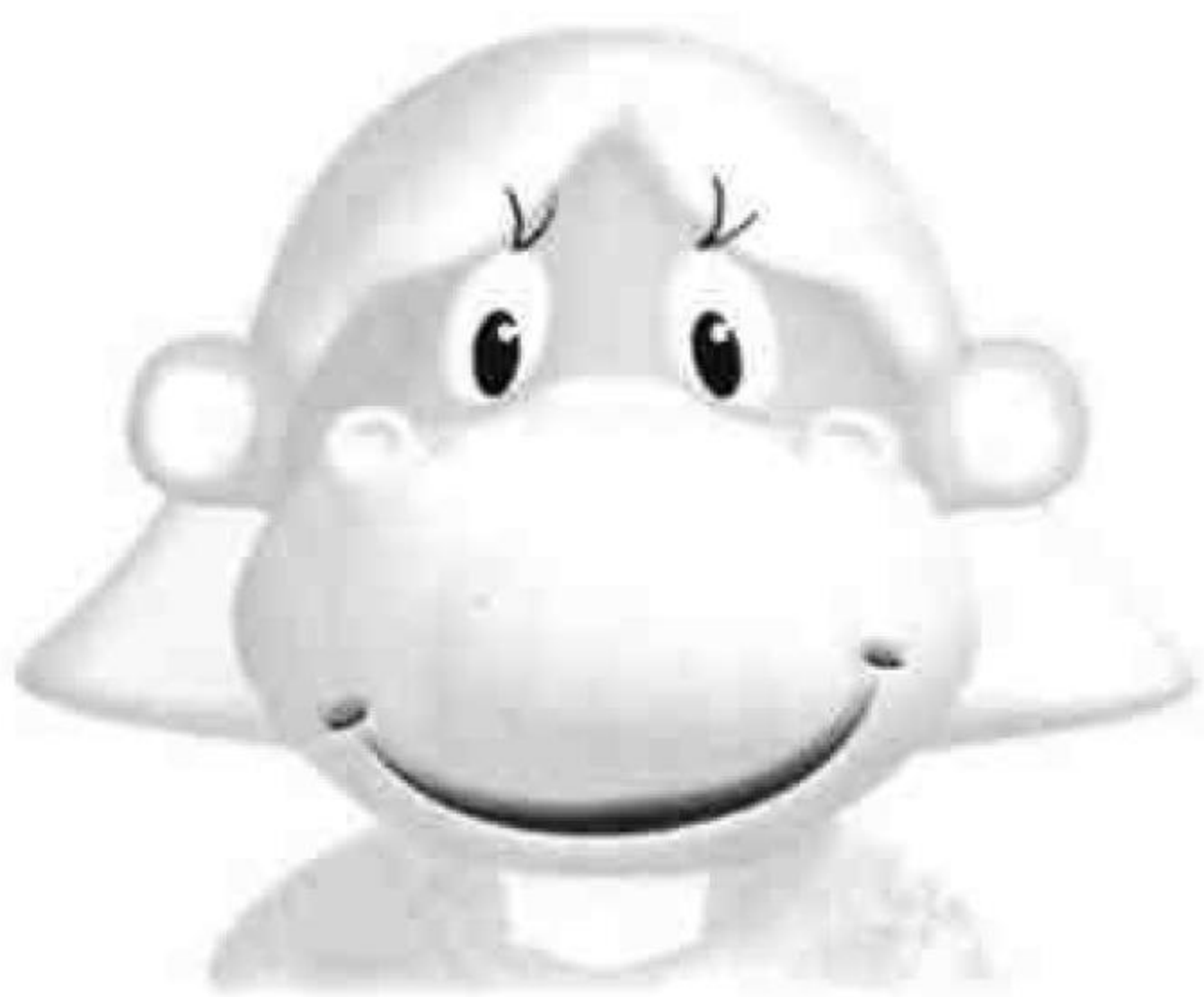

3

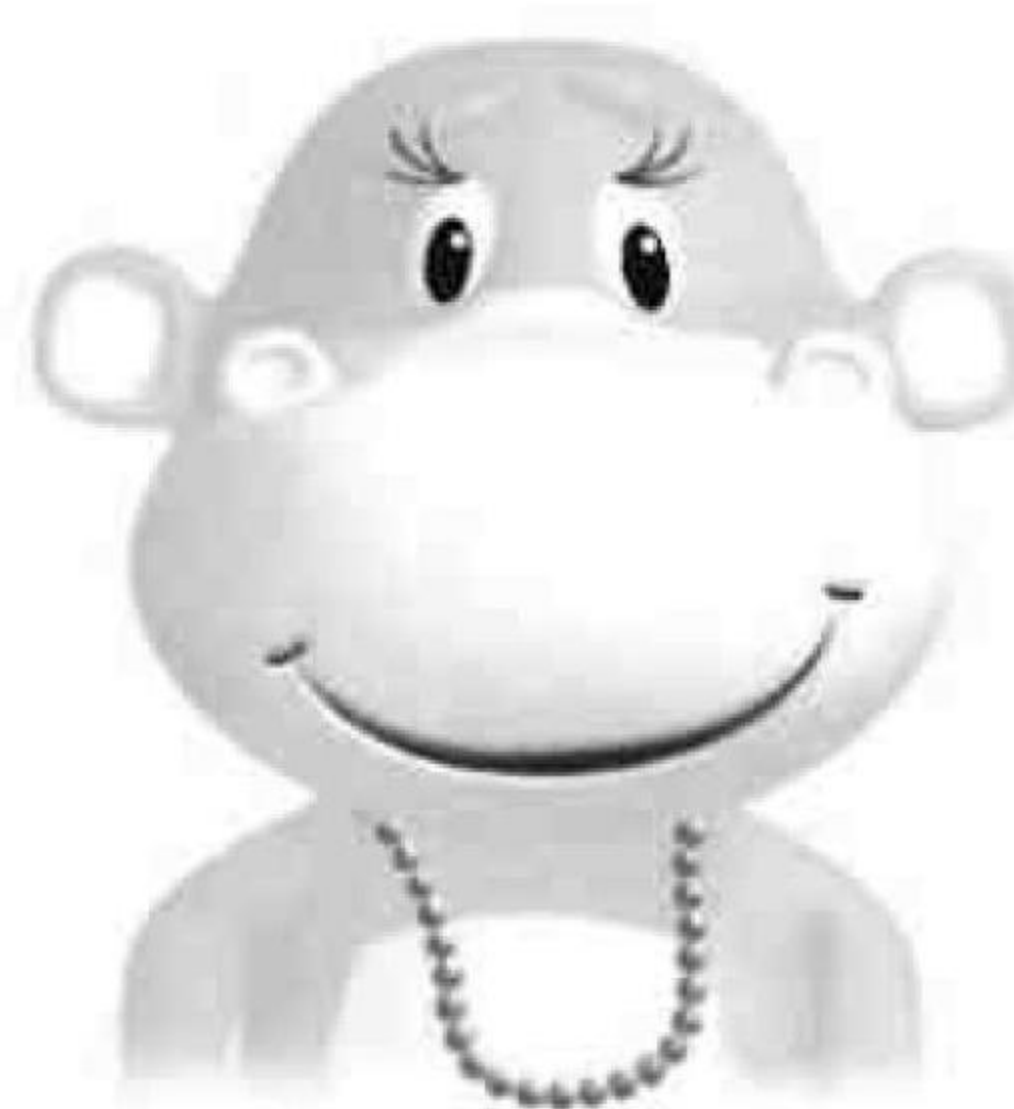

4



1 Think! Look and colour.



1

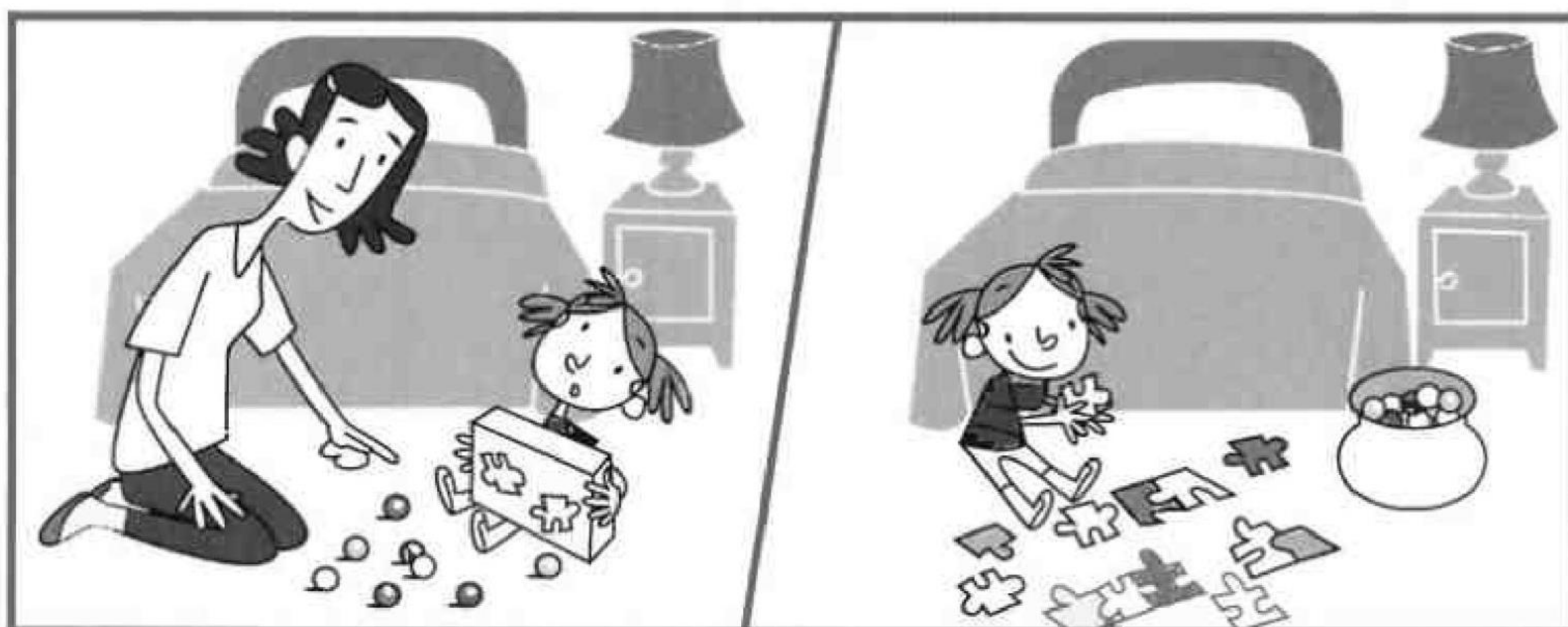

2

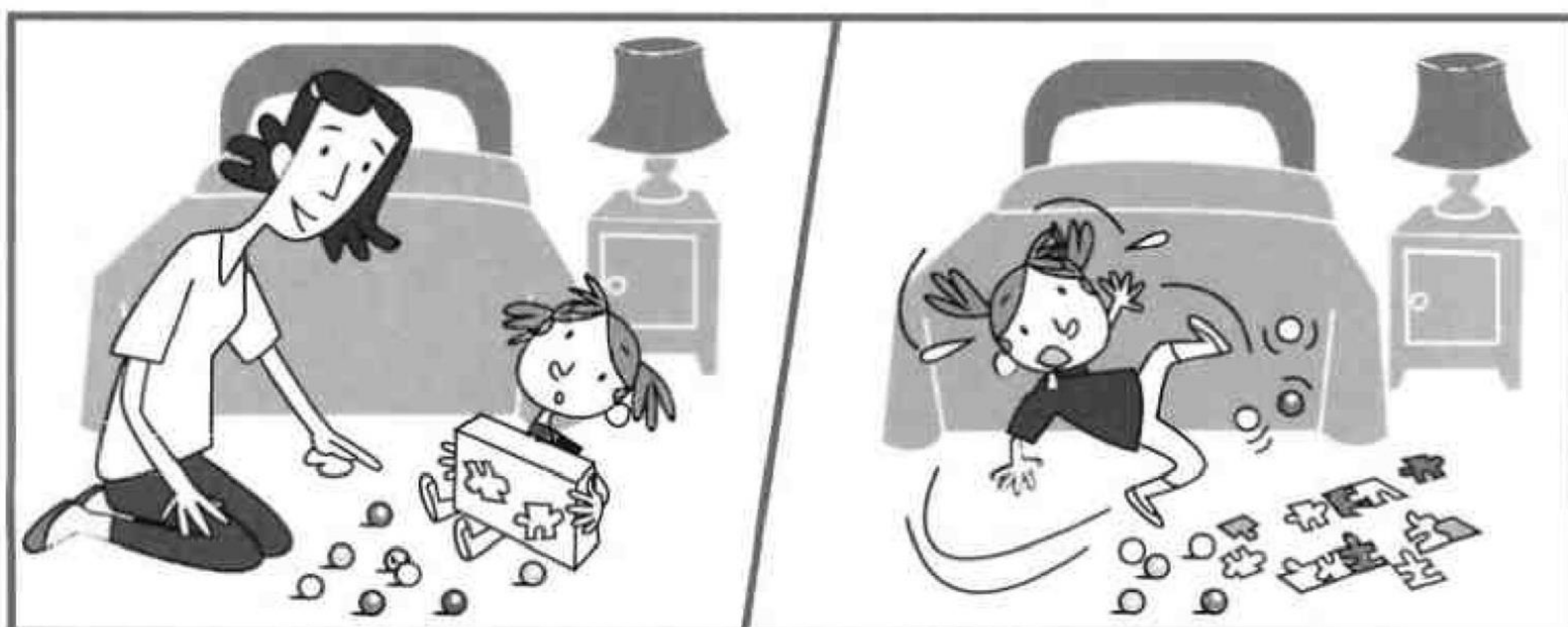

Listen and colour.

1	2	3	4	5	6
---	---	---	---	---	---

2 Think! Look and colour.

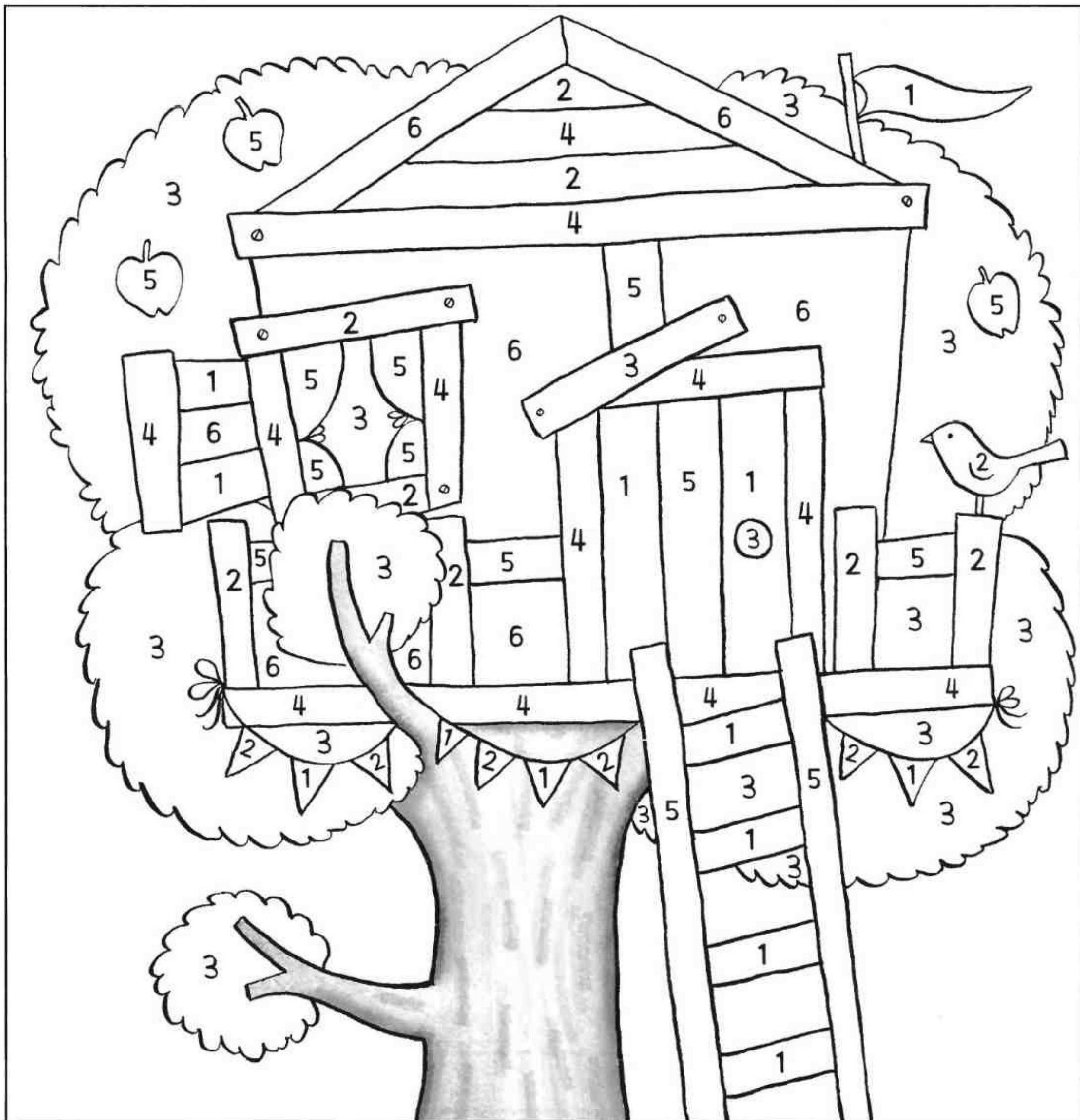

1 Think! Follow the path. Count and circle.

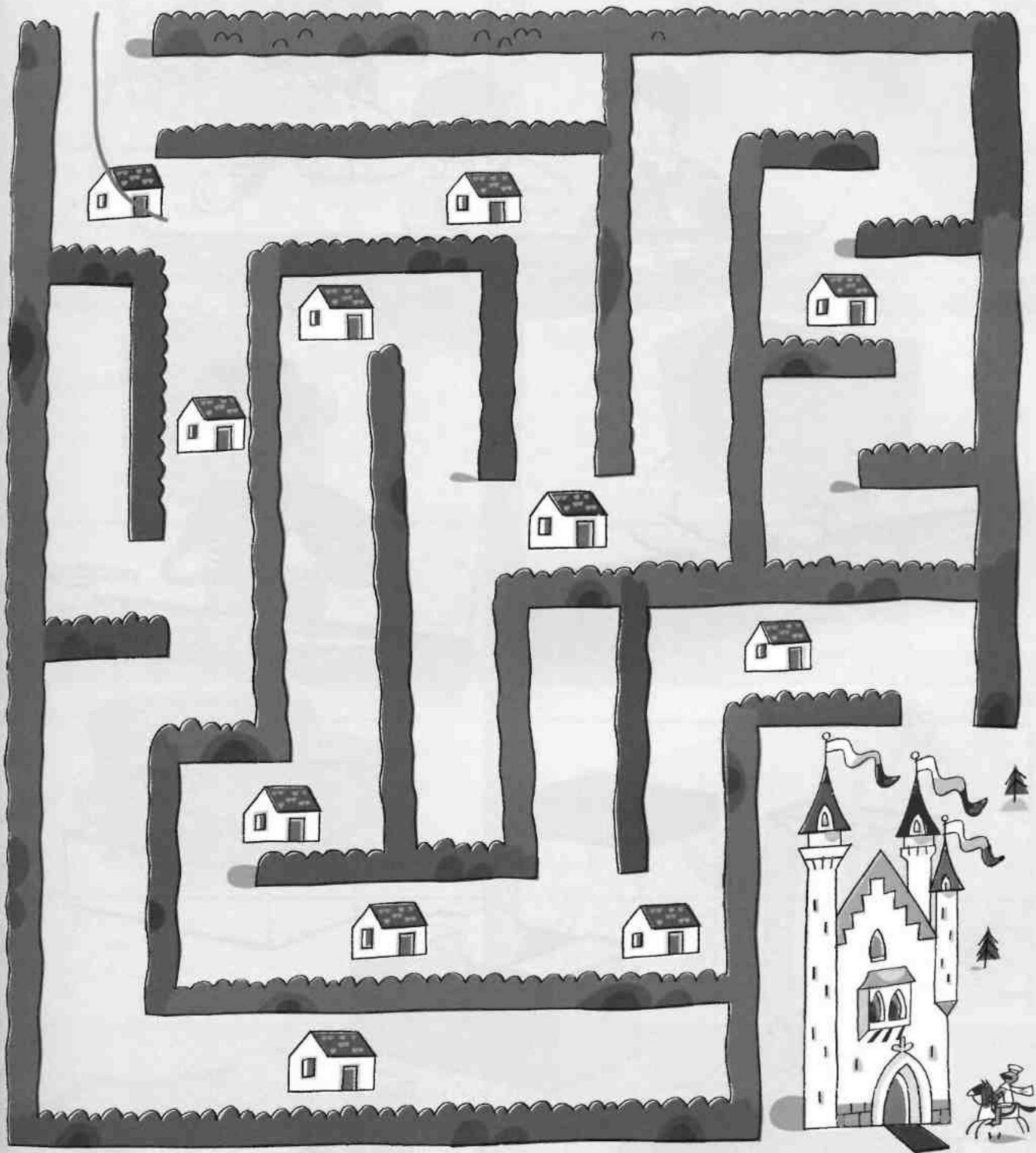

1

2

3

4

5

6

7

8

9

10

1 Make dolls' furniture.

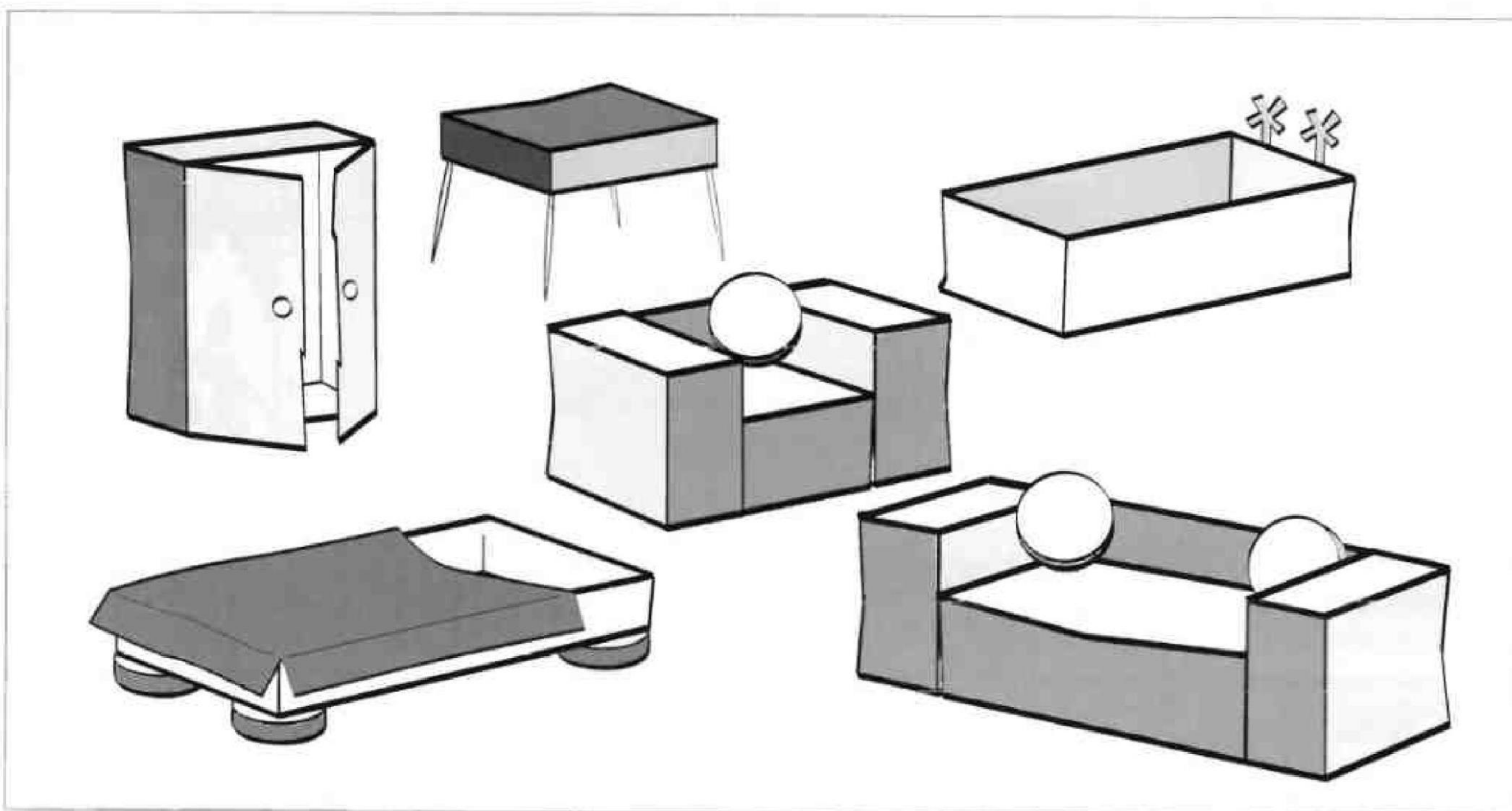

1 Say the words and trace. Colour the circles.



bed

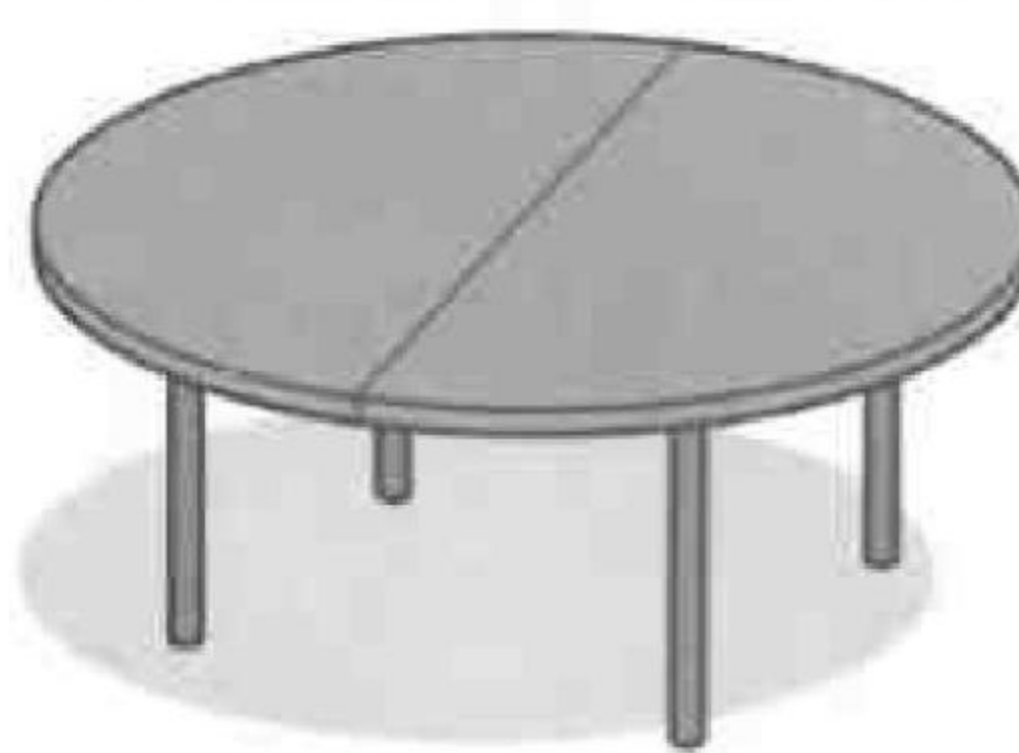

table

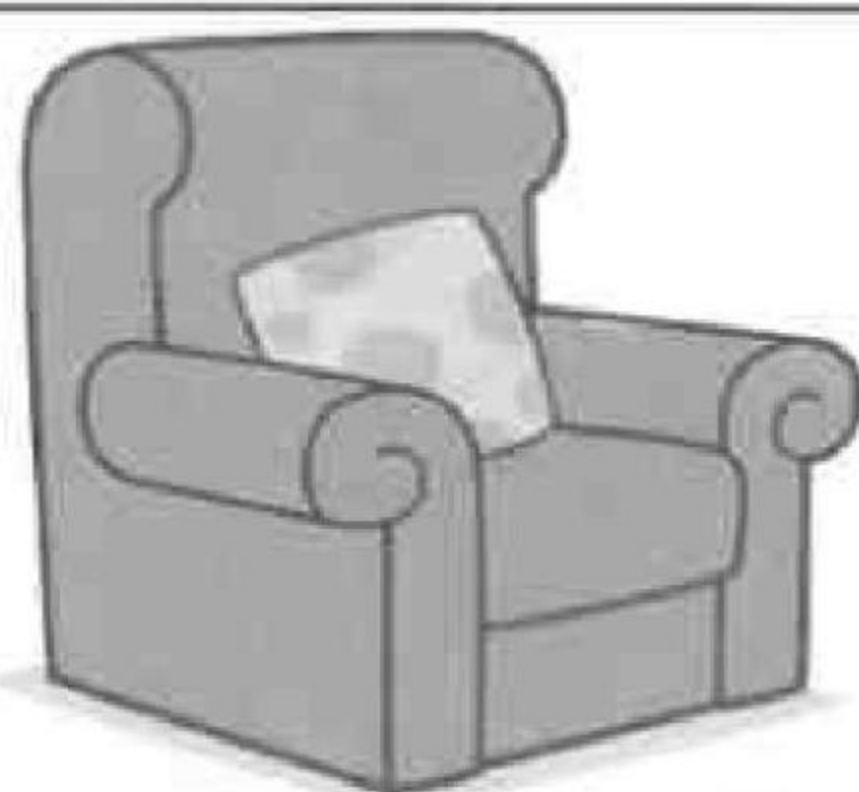

armchair

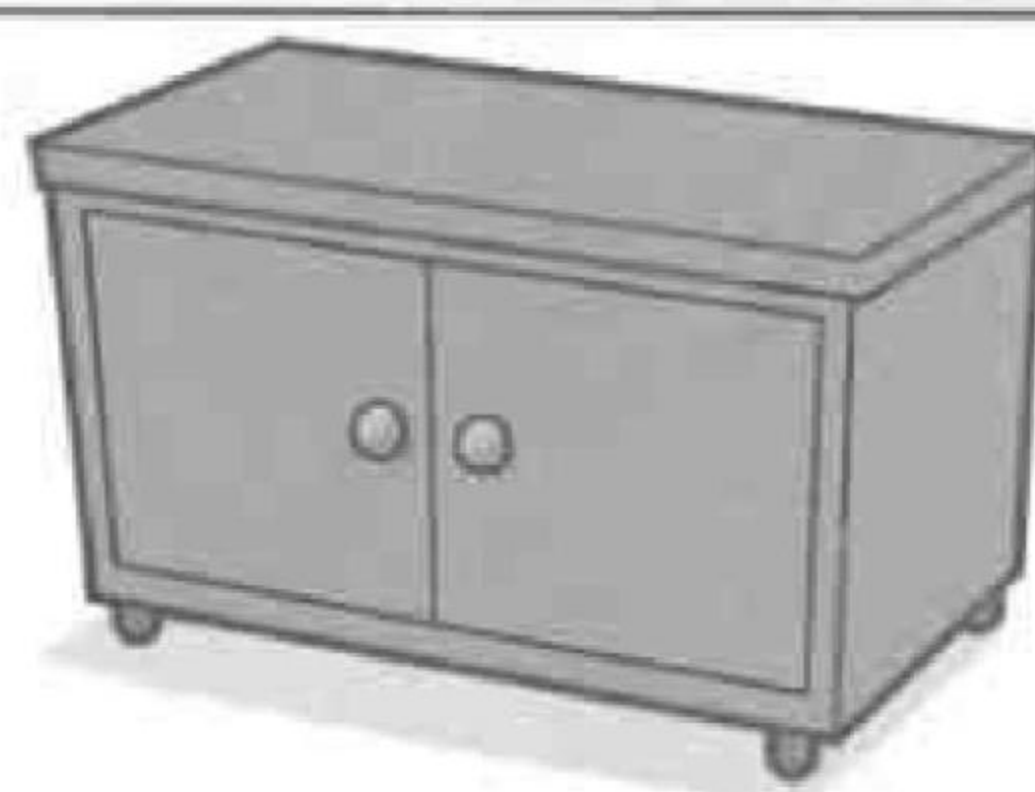

cupboard

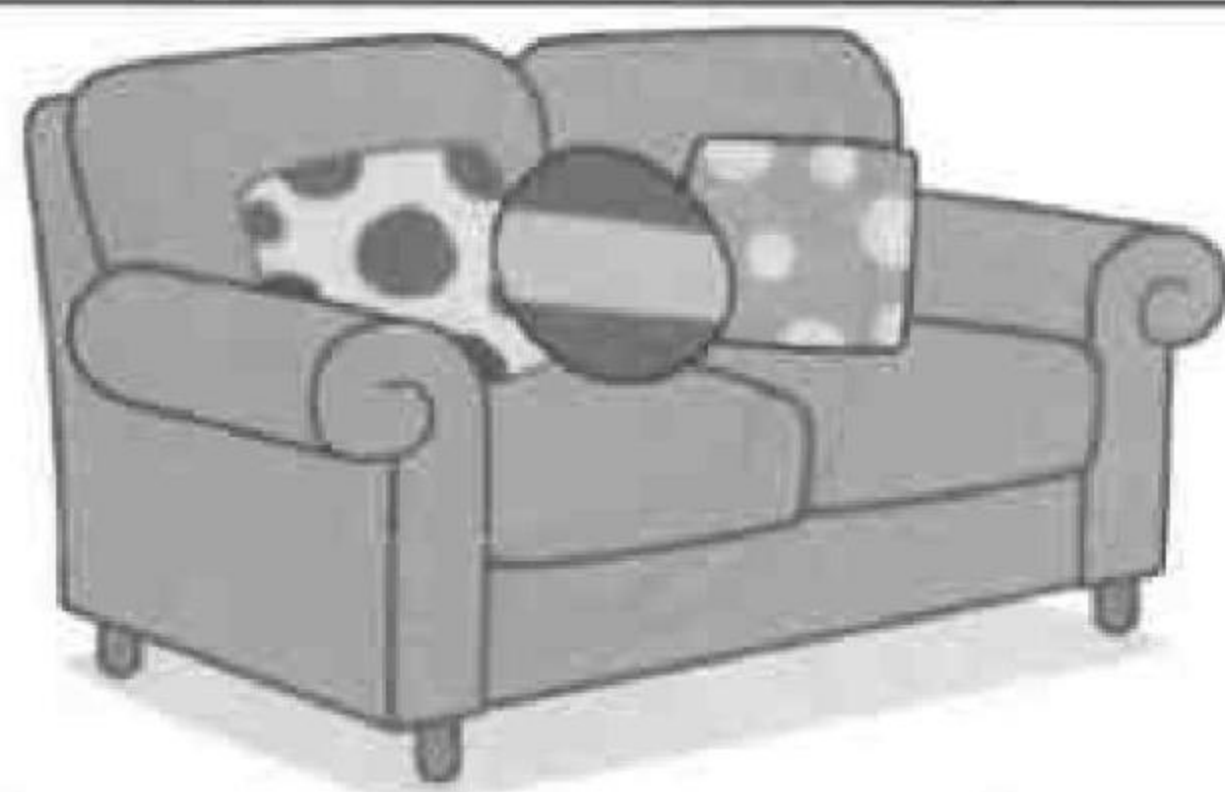

sofa



bath



2 Draw faces. 😊 😐 😞

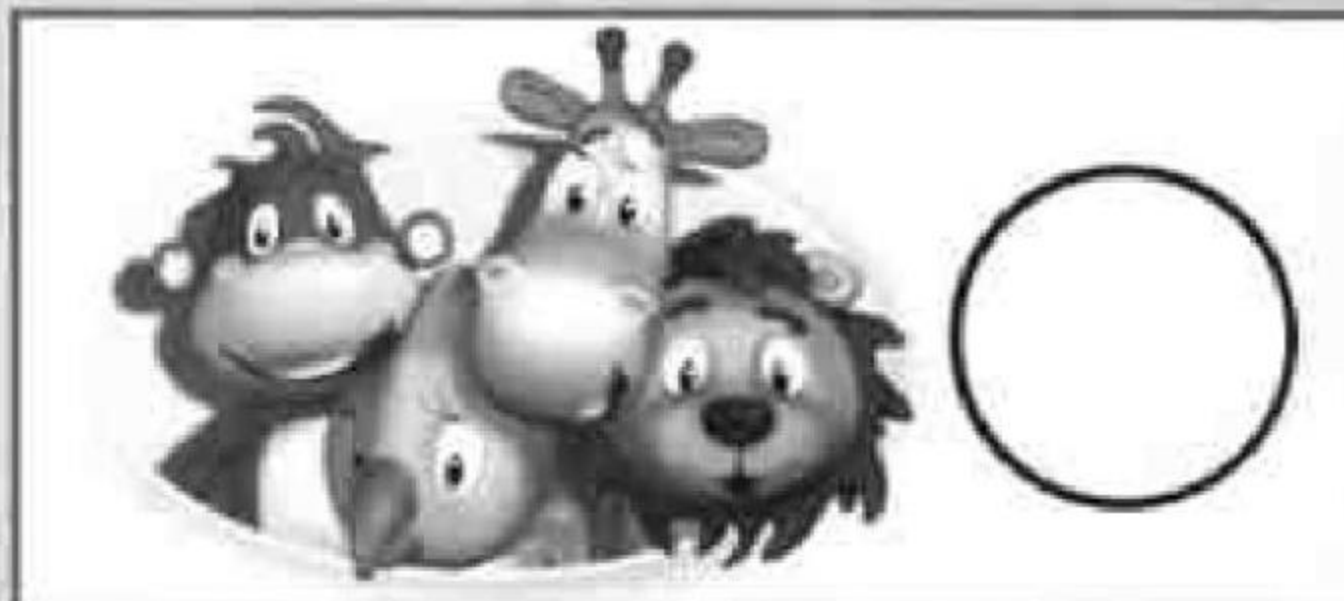

1 Complete the animals. Say the words.

1



dog

2



cat

3



sheep

4



cow

5



rabbit

6



horse

1 Draw your favourite animals.



Listen, point and say the words.



1 CD2
20 Listen and colour. Follow the paths.

1

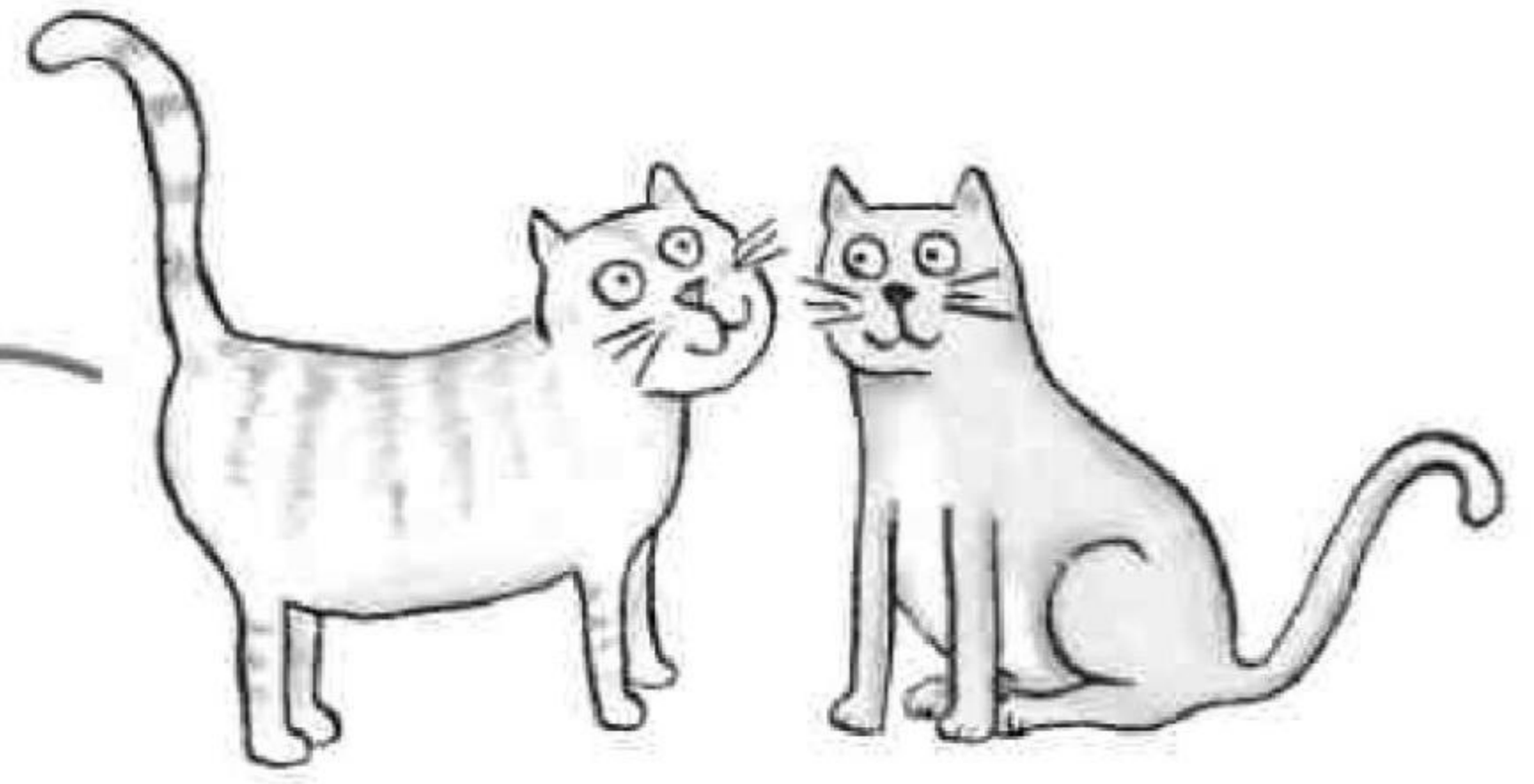
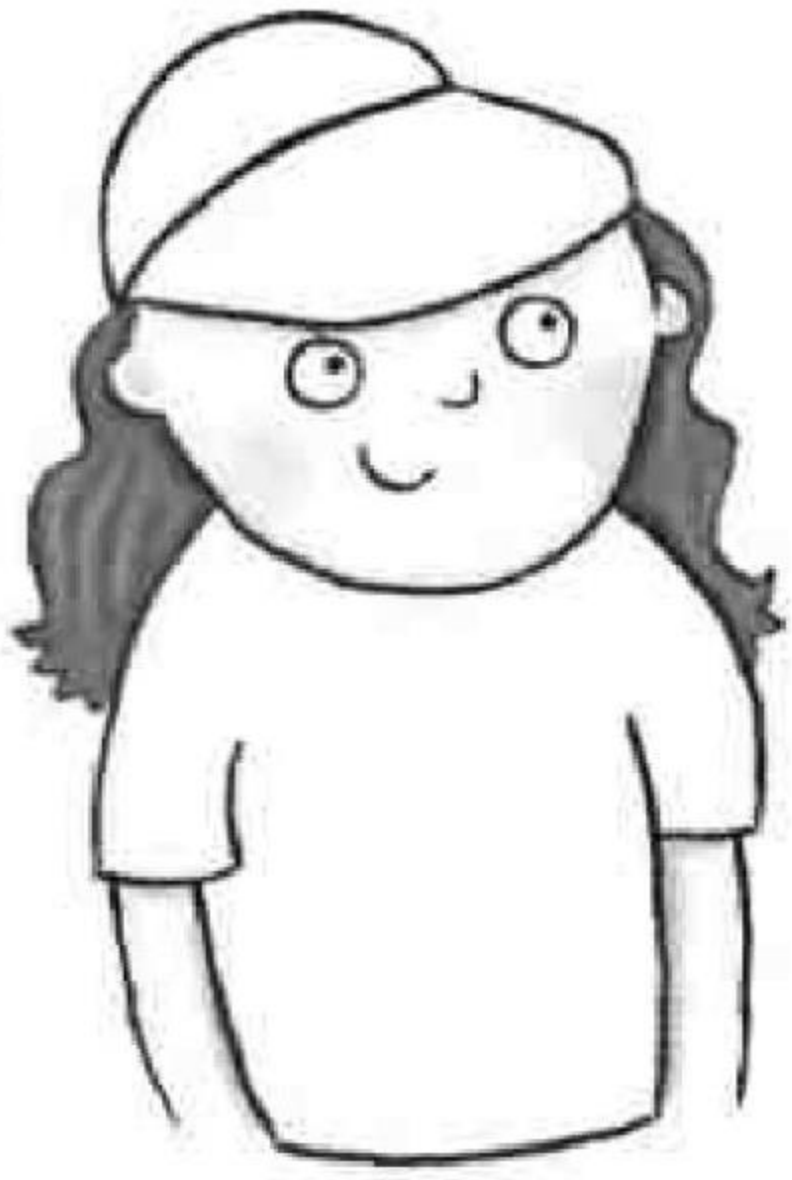

2

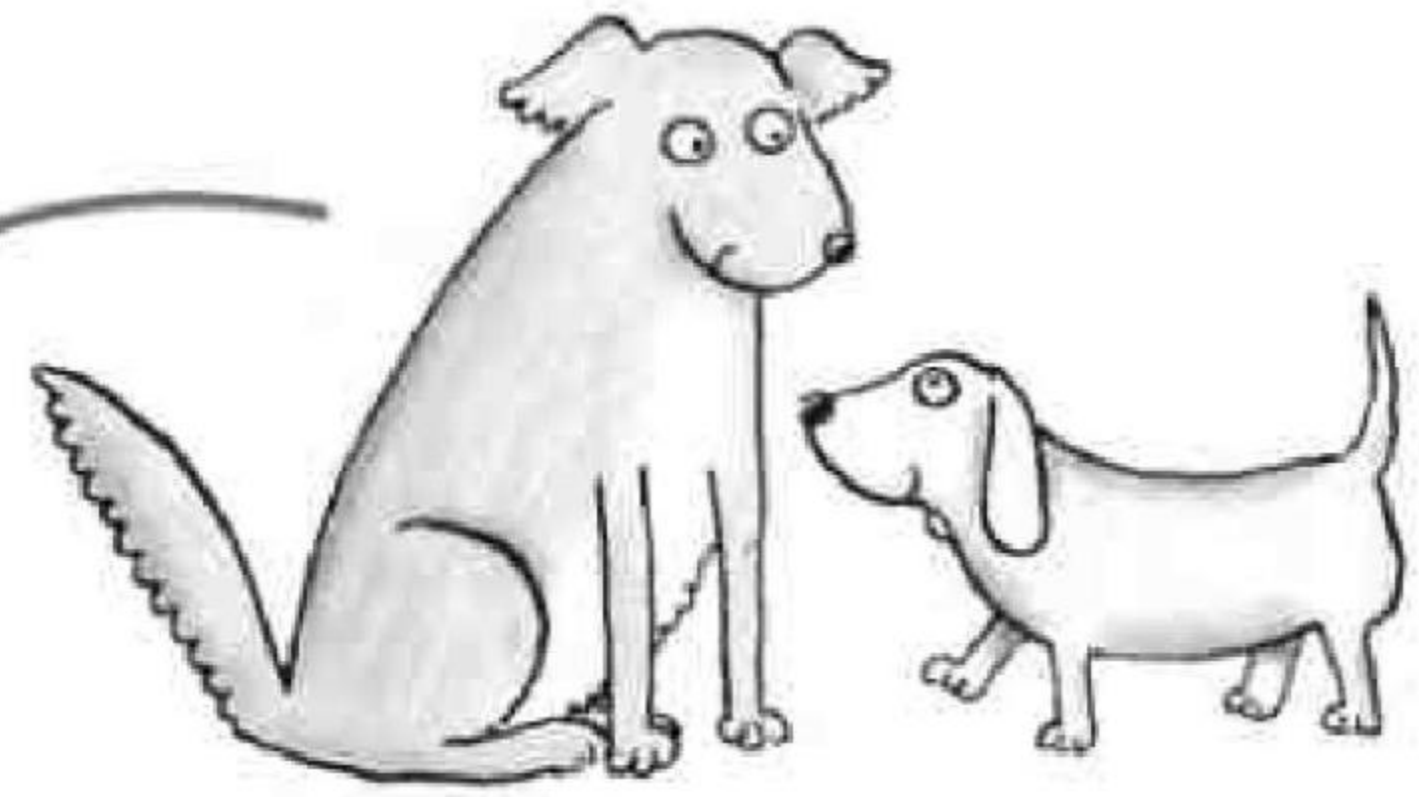

3

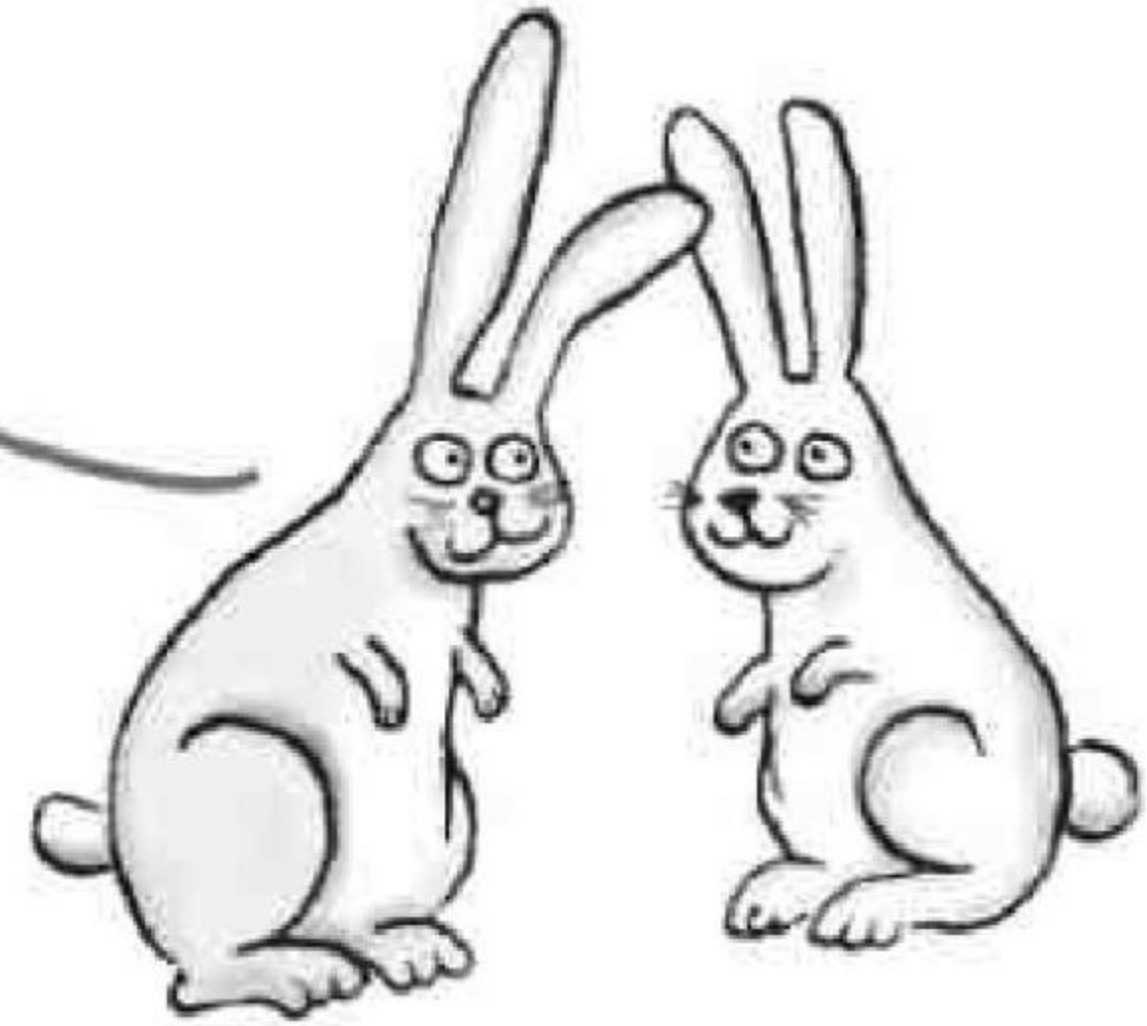

4

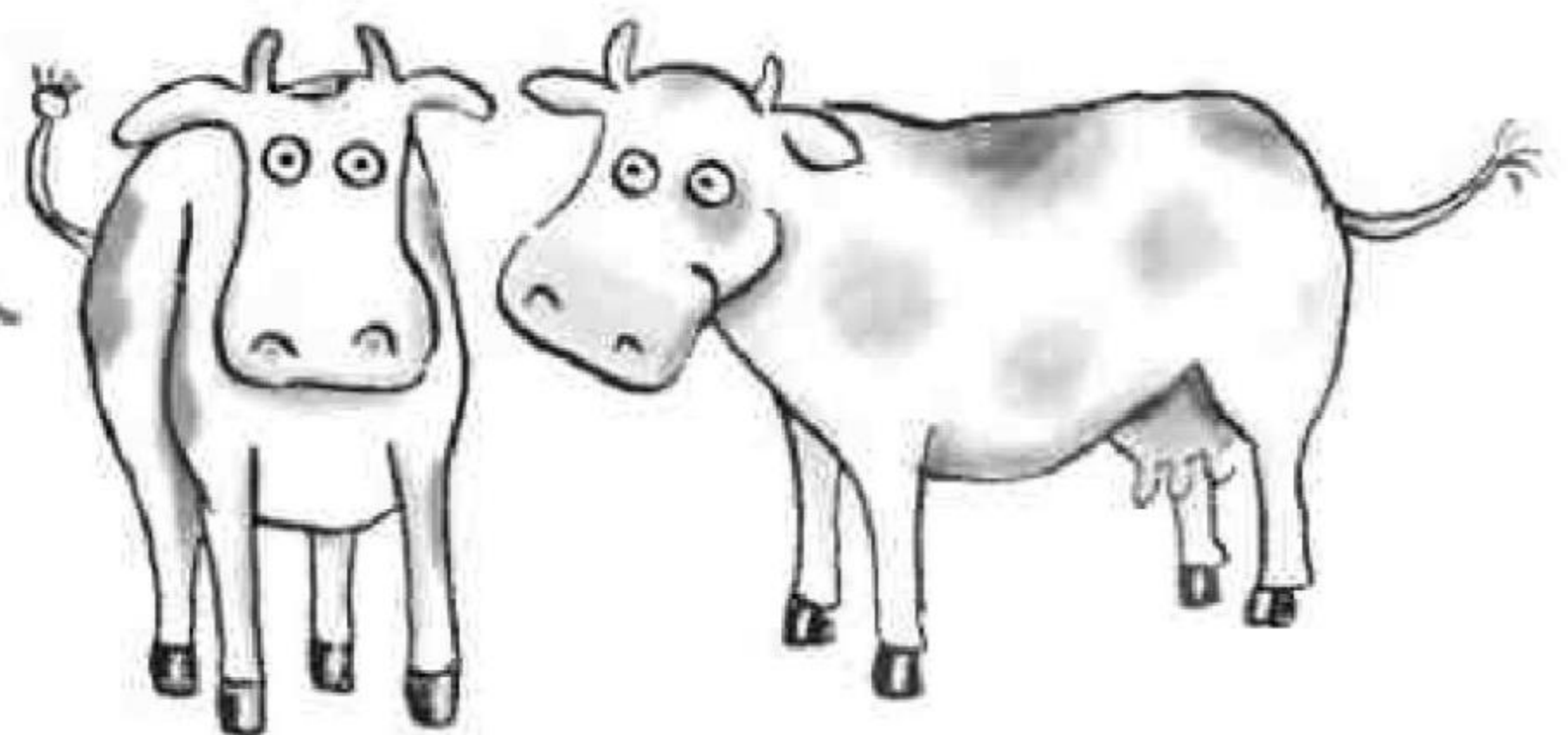

My favourite colour is (blue) / (toys) are (planes).

Listen and trace.

1

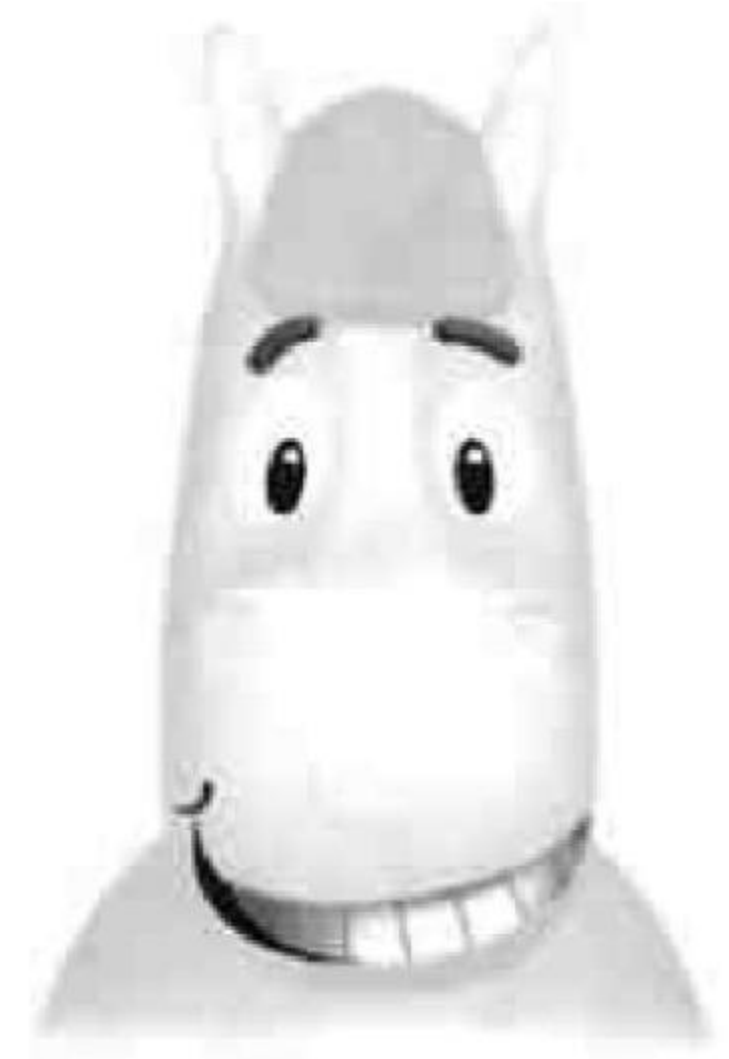

2

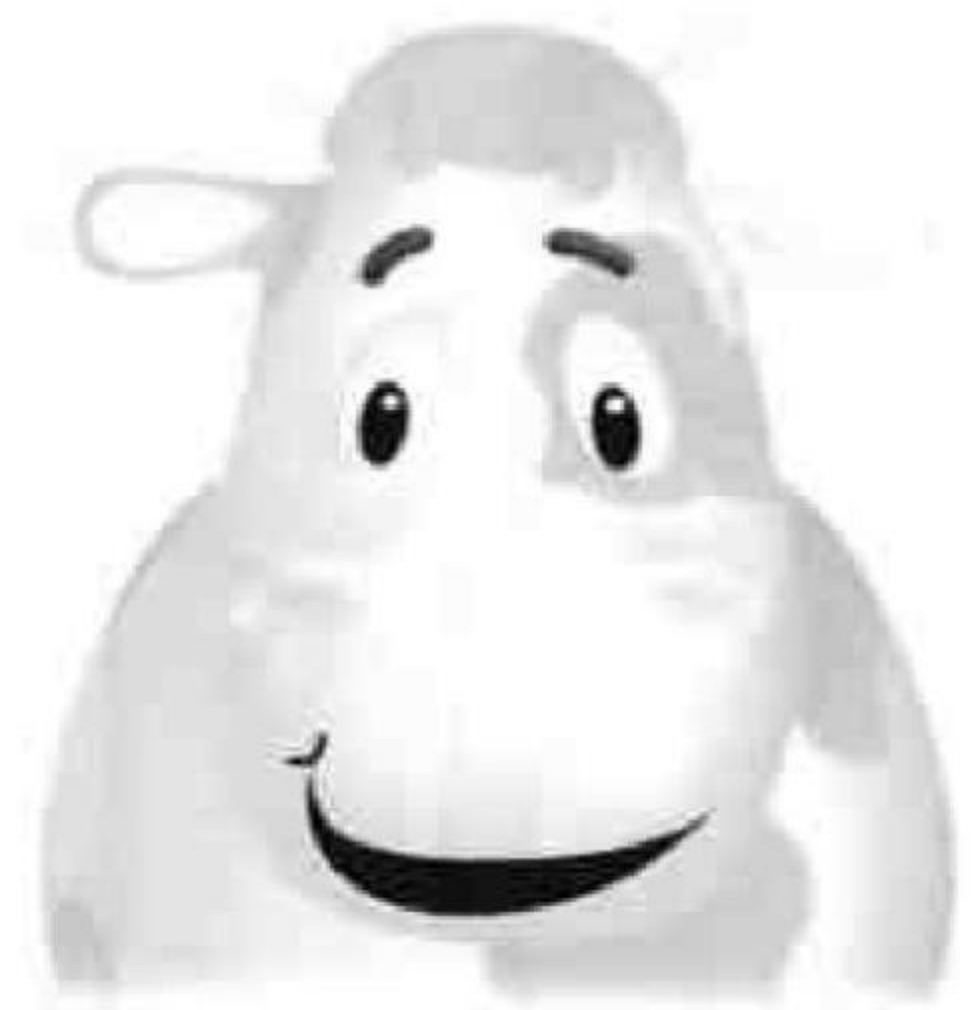

3

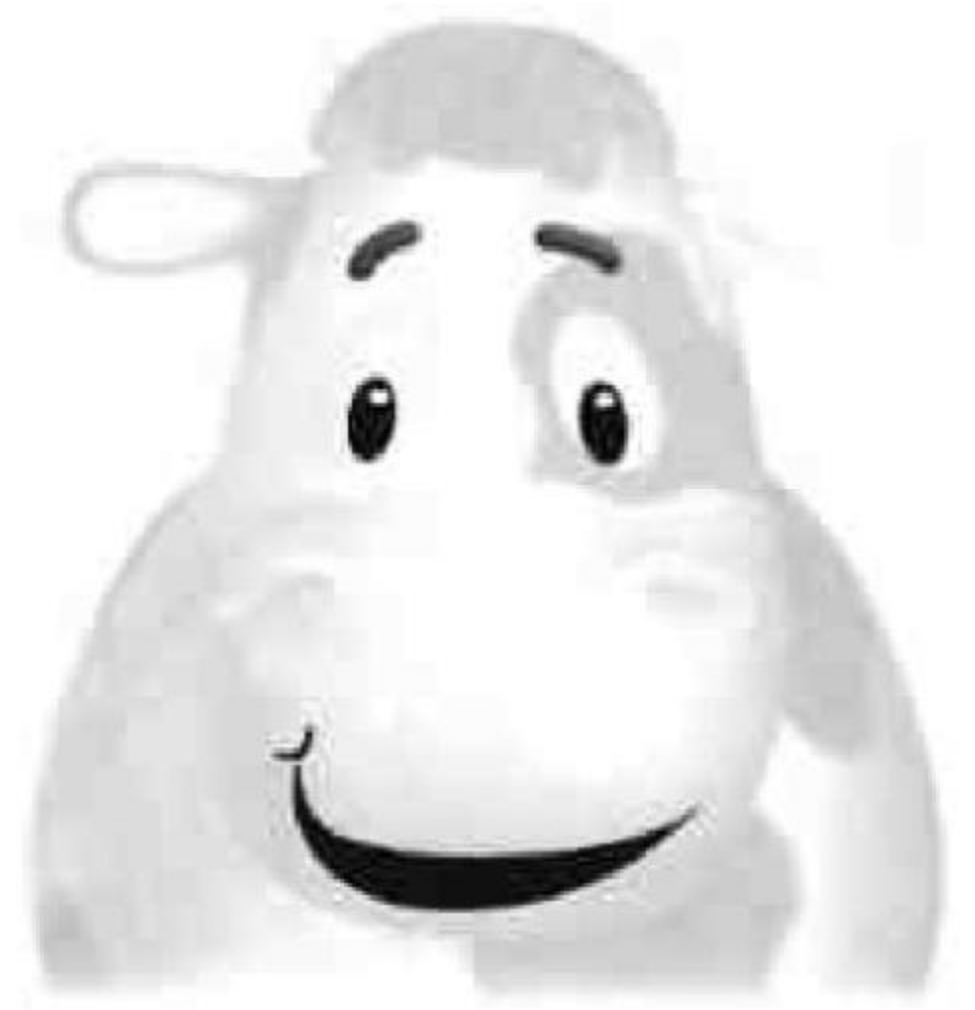

4



1 Think! Look and colour.

1

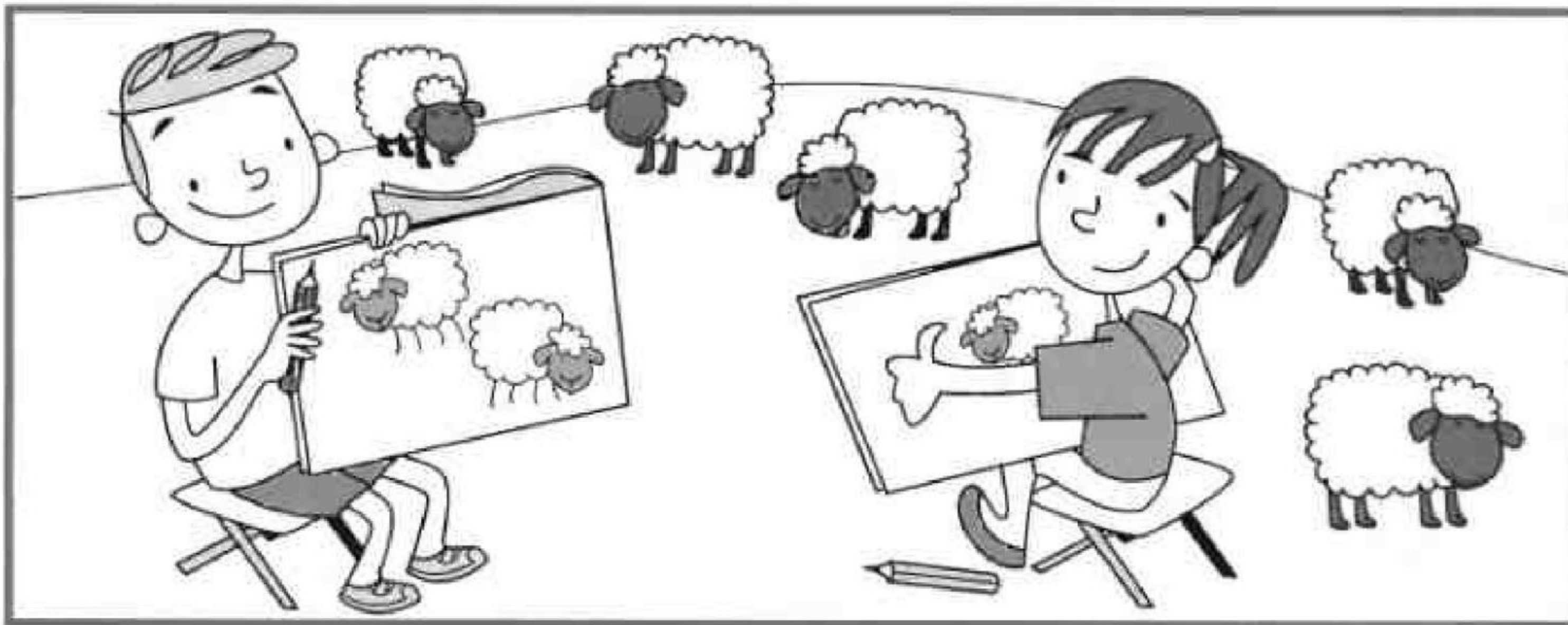

2

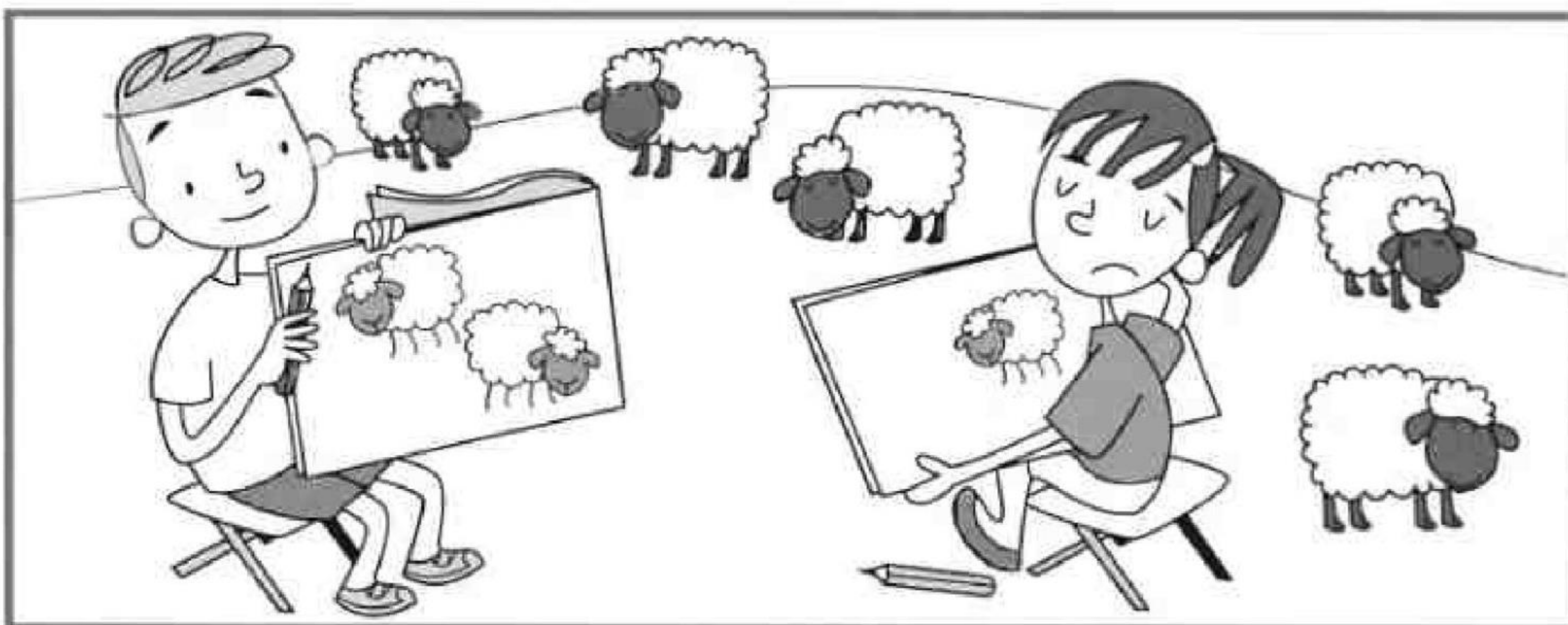

1

Match. Where do they live?

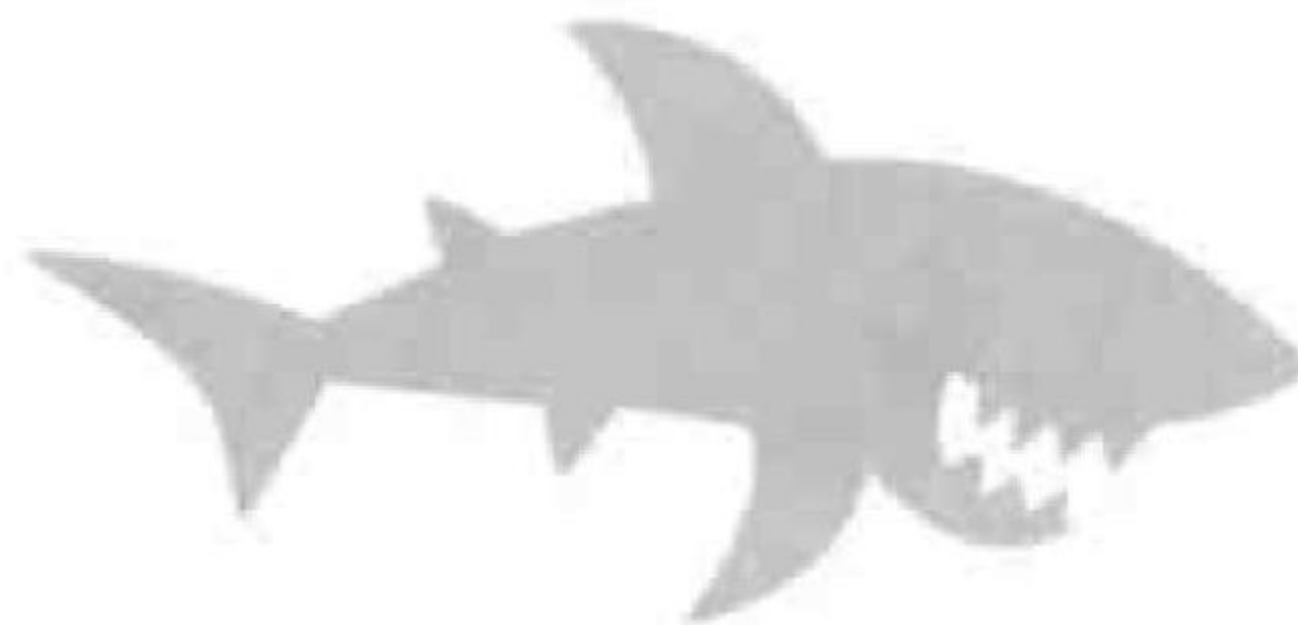
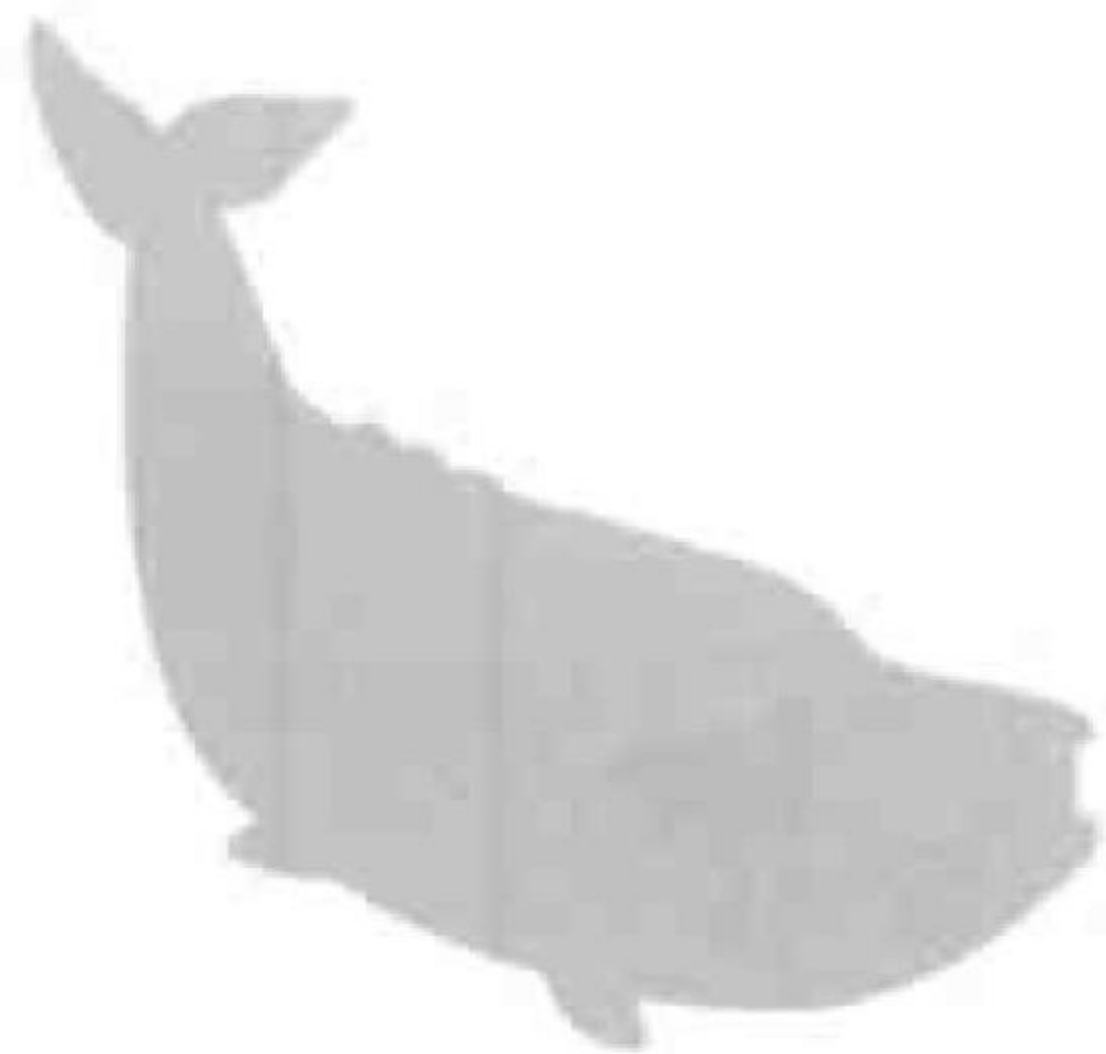
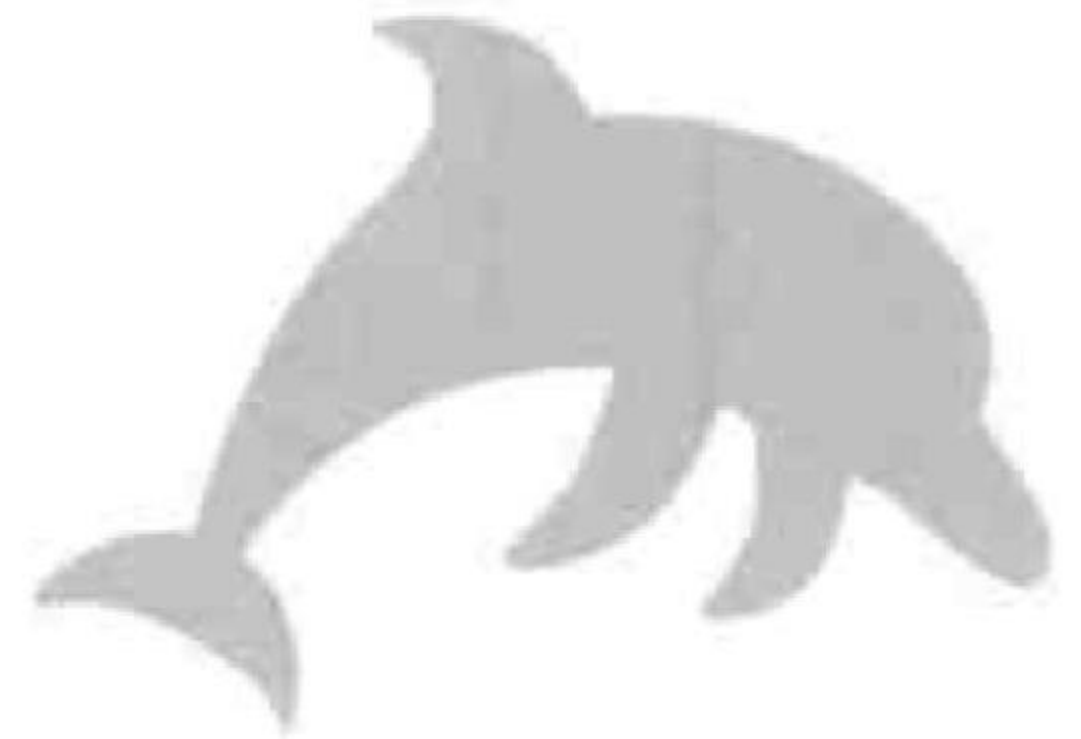
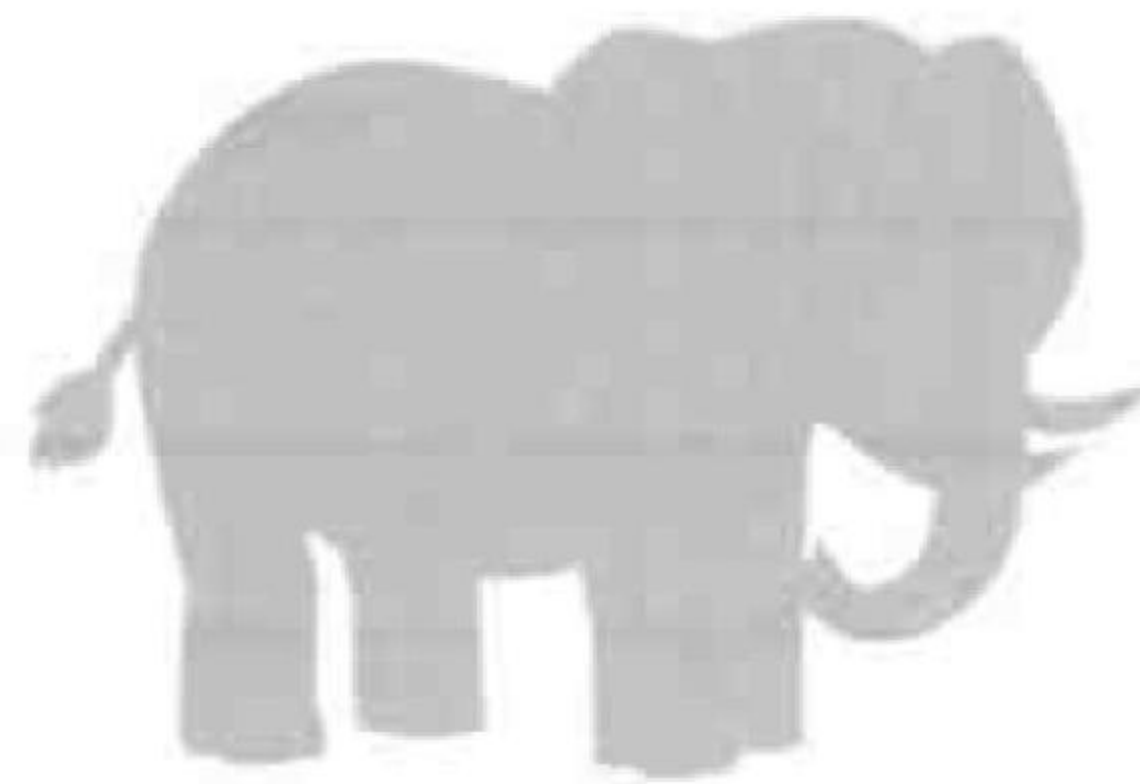
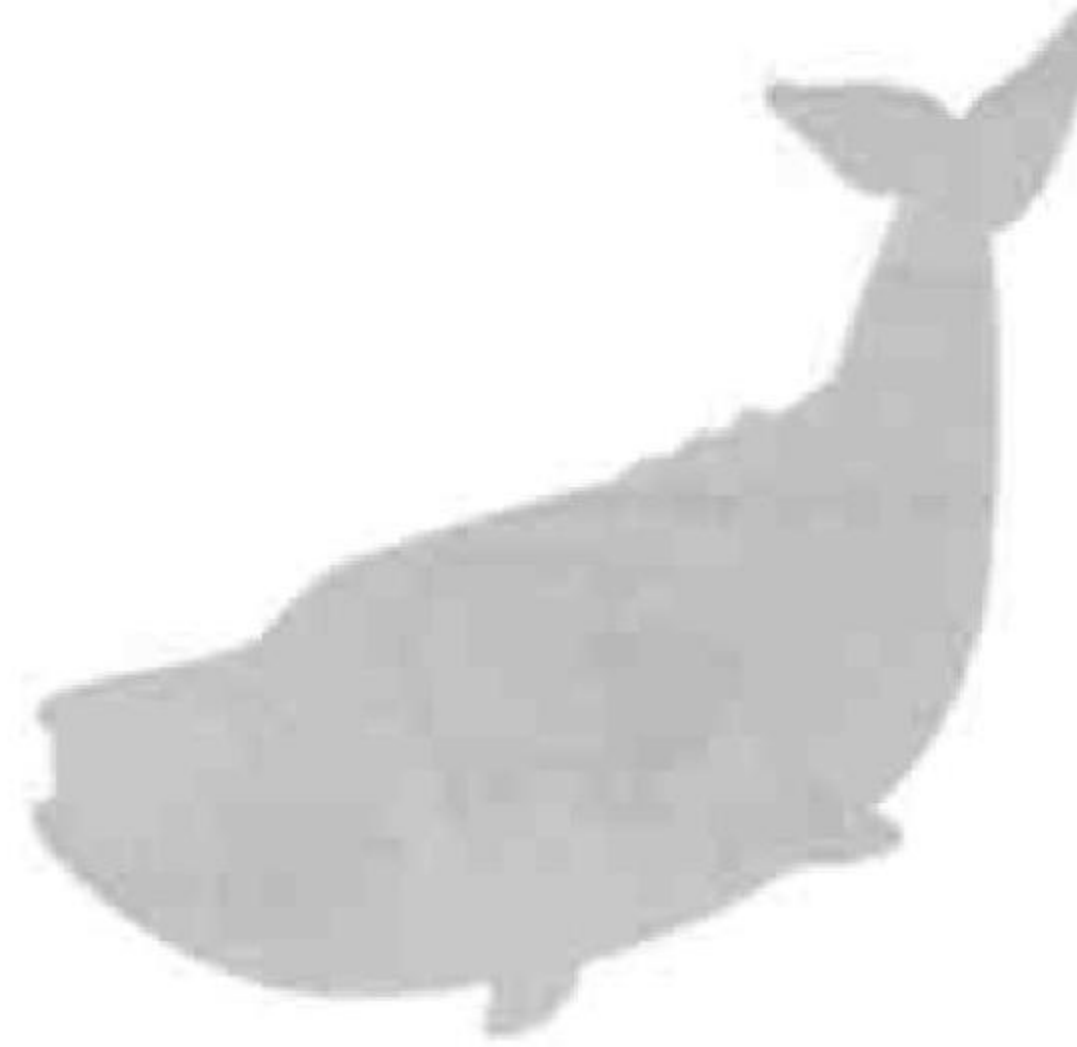
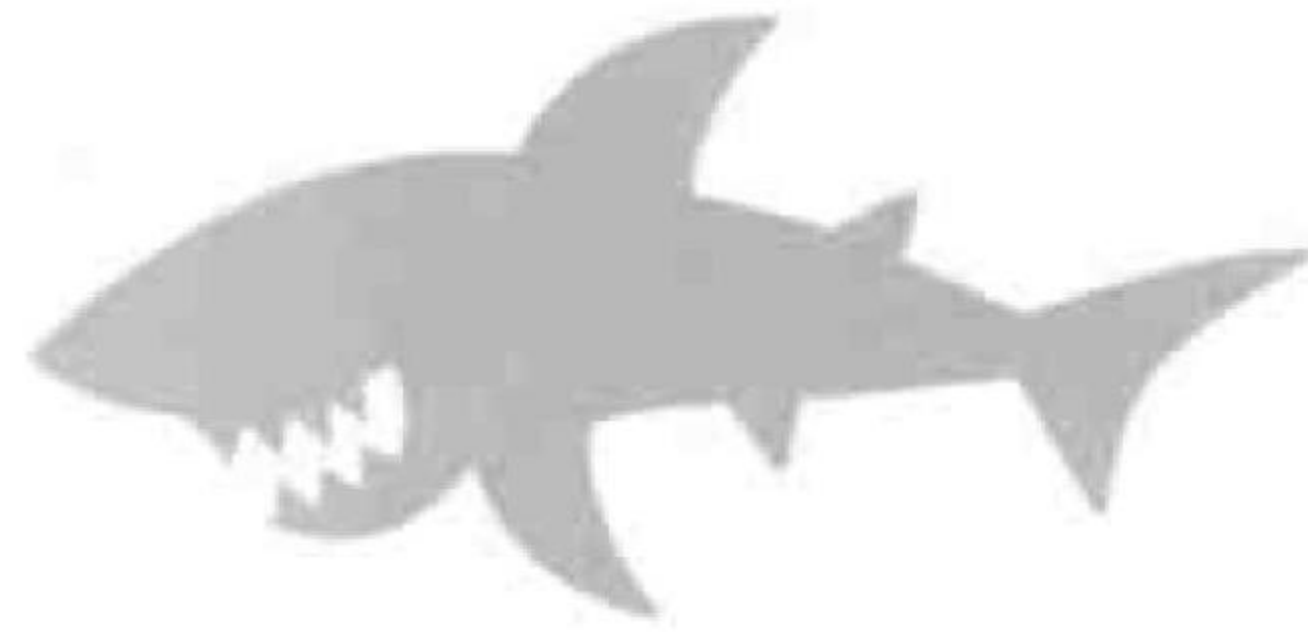
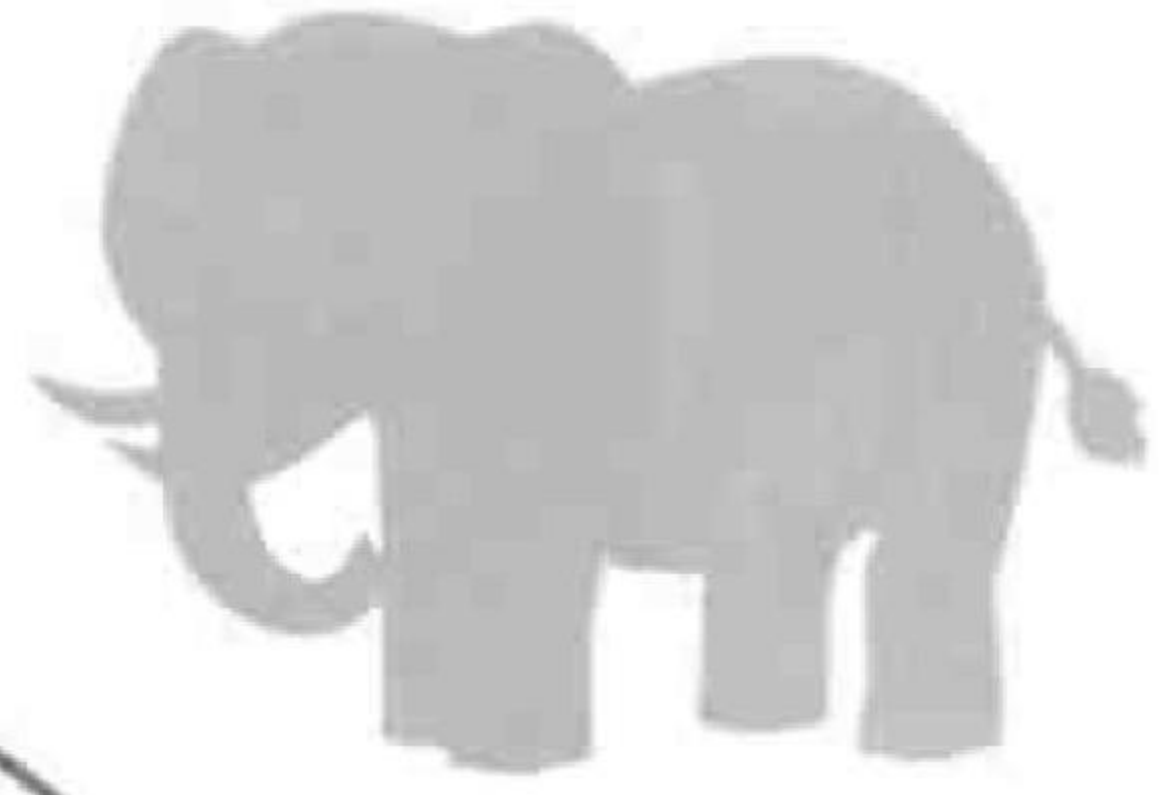
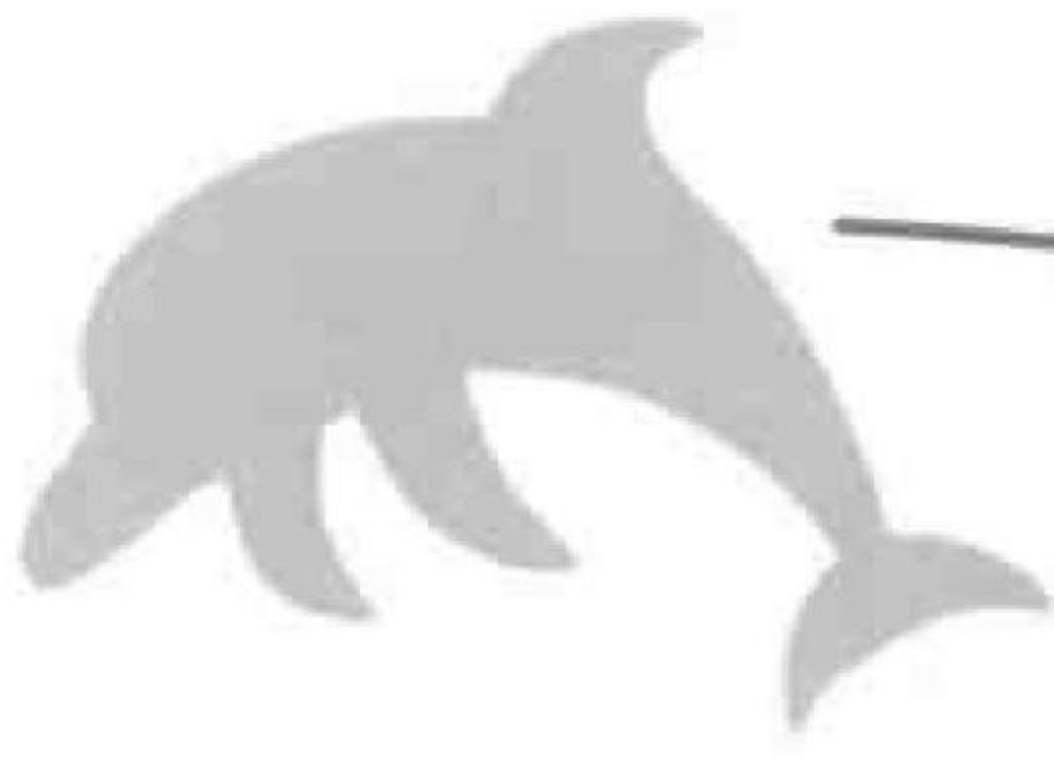

1 Think! Look and cross out.

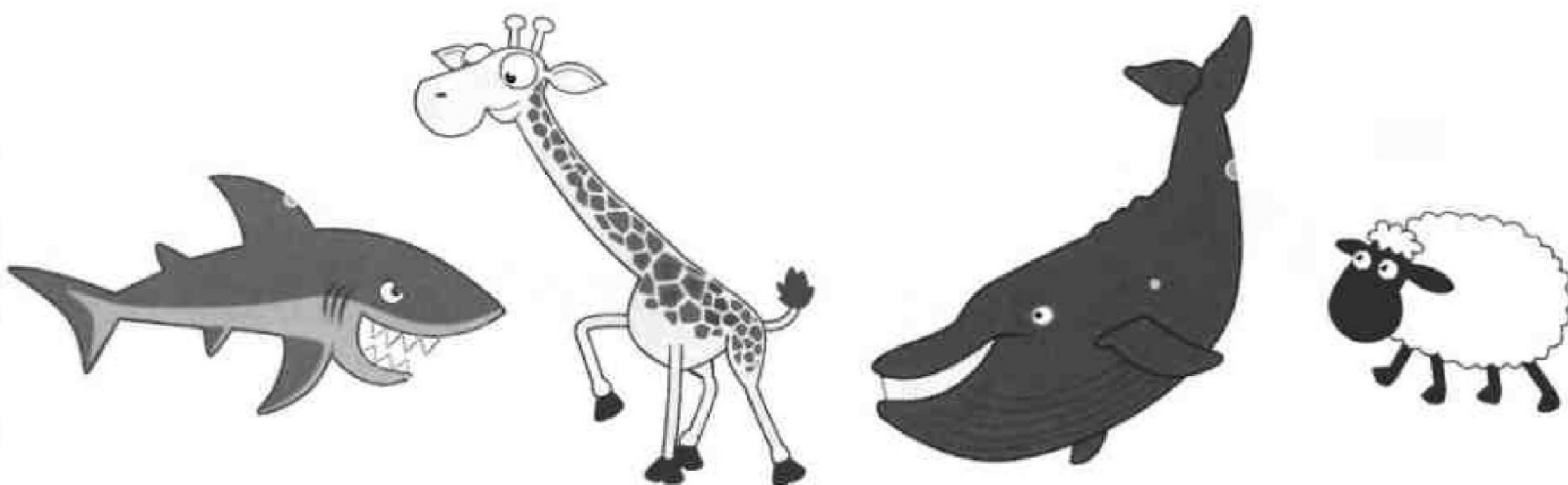
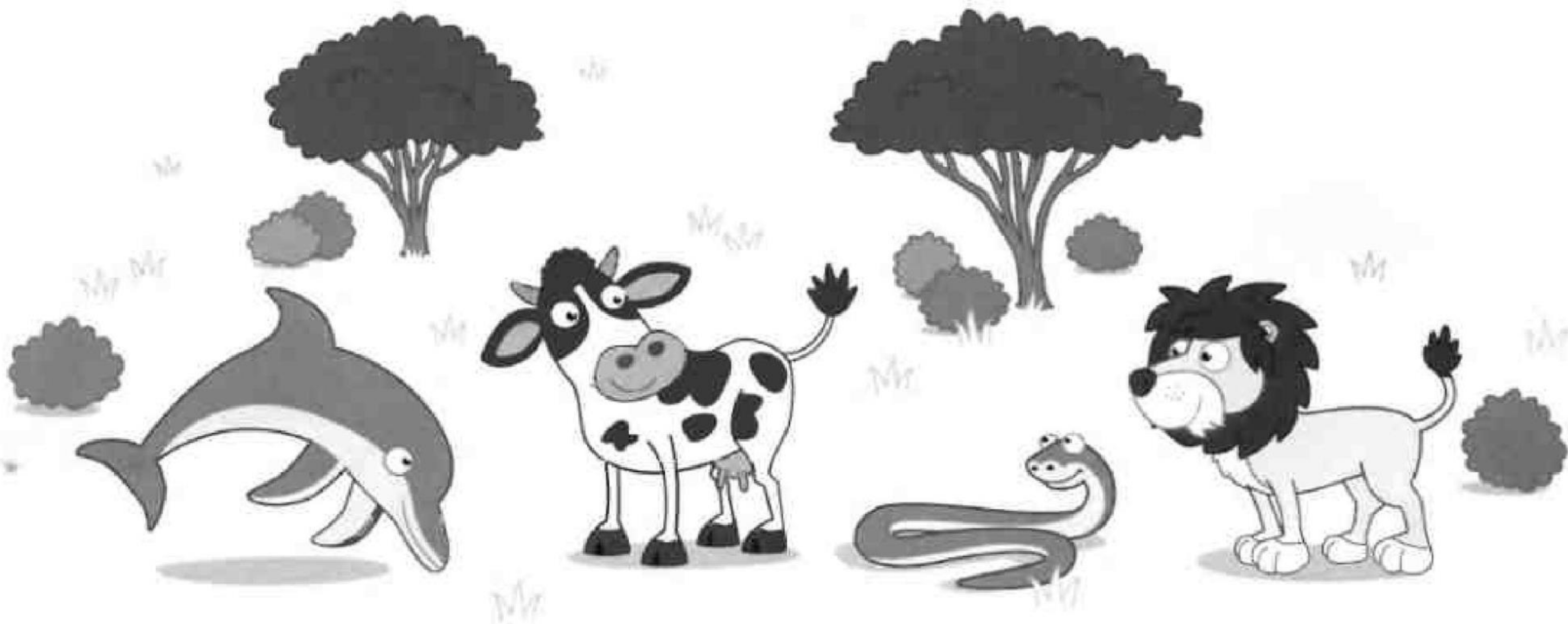
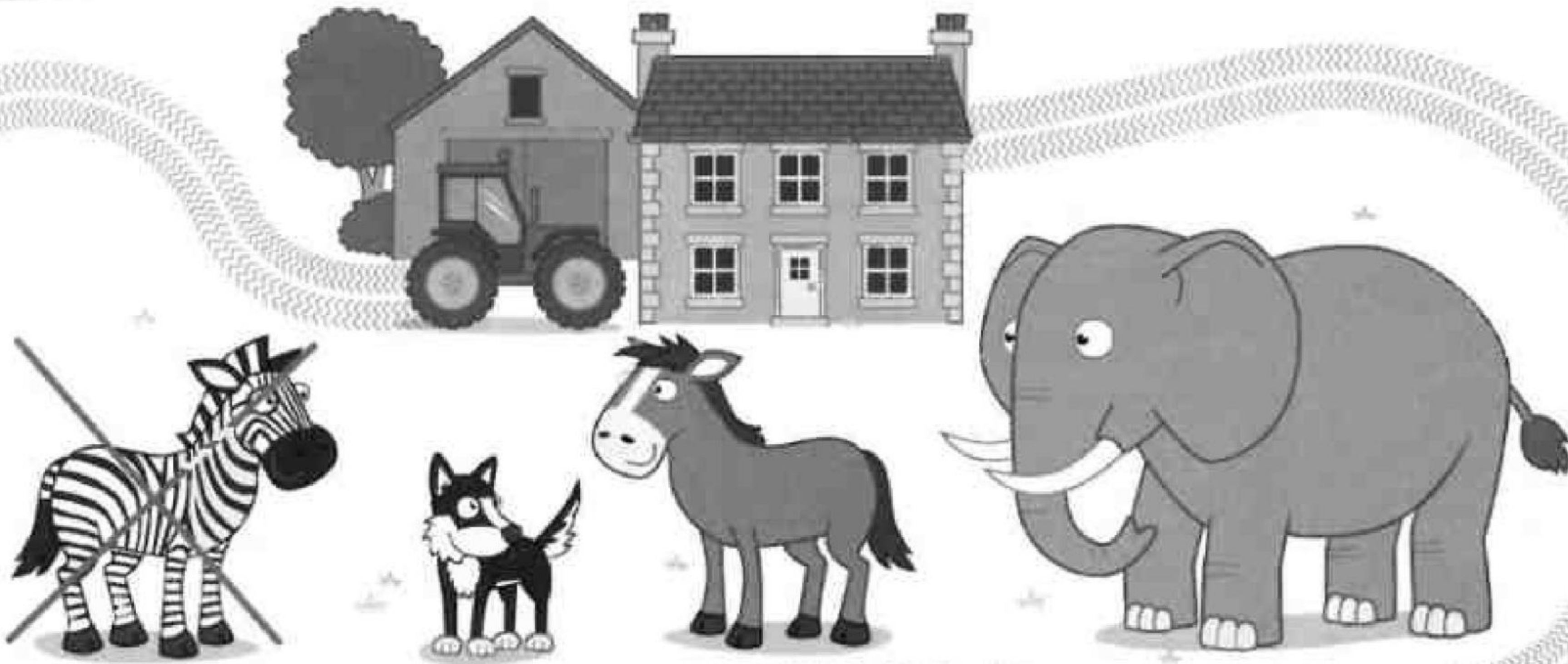

1 Make a woolly sheep.

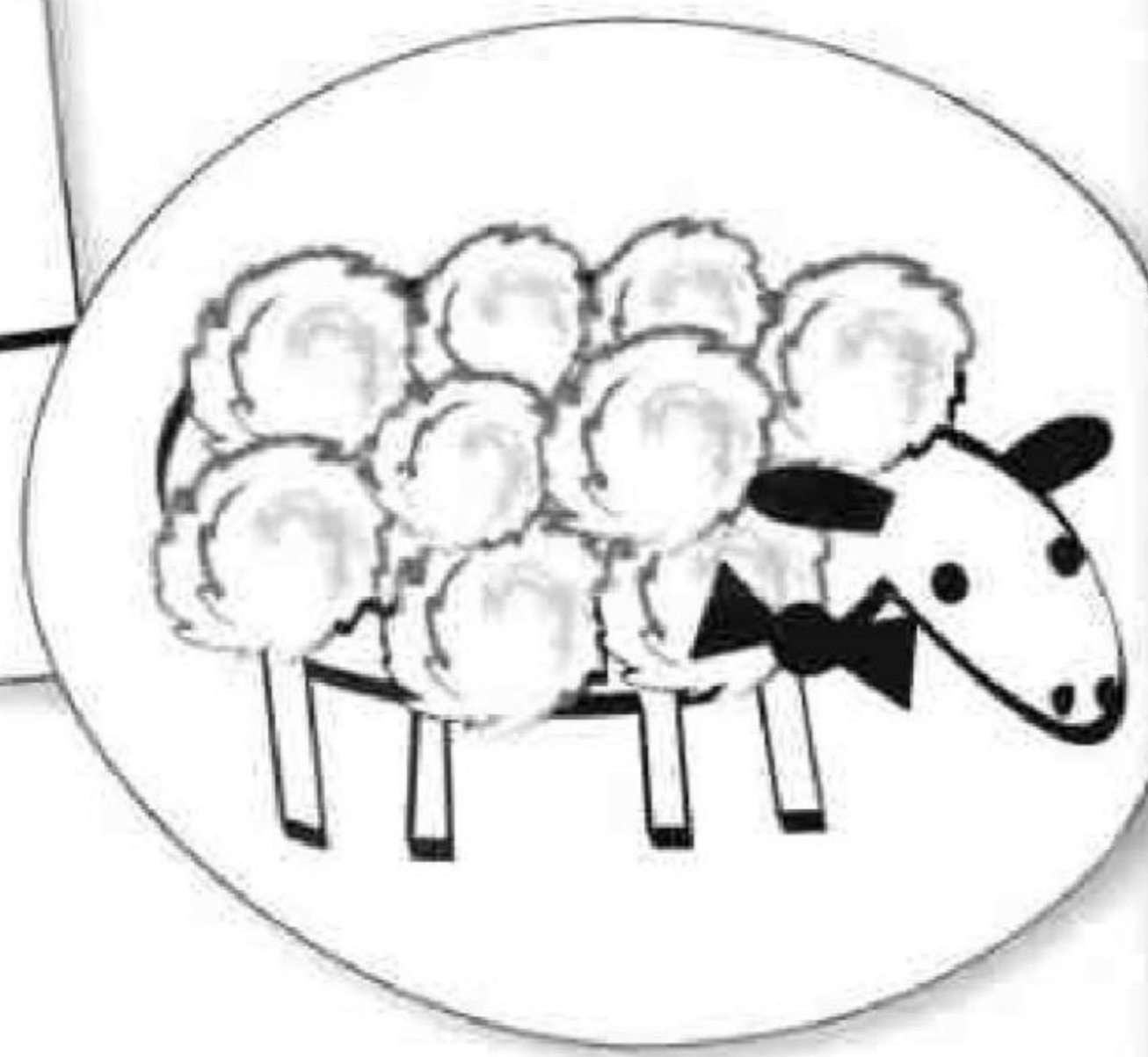
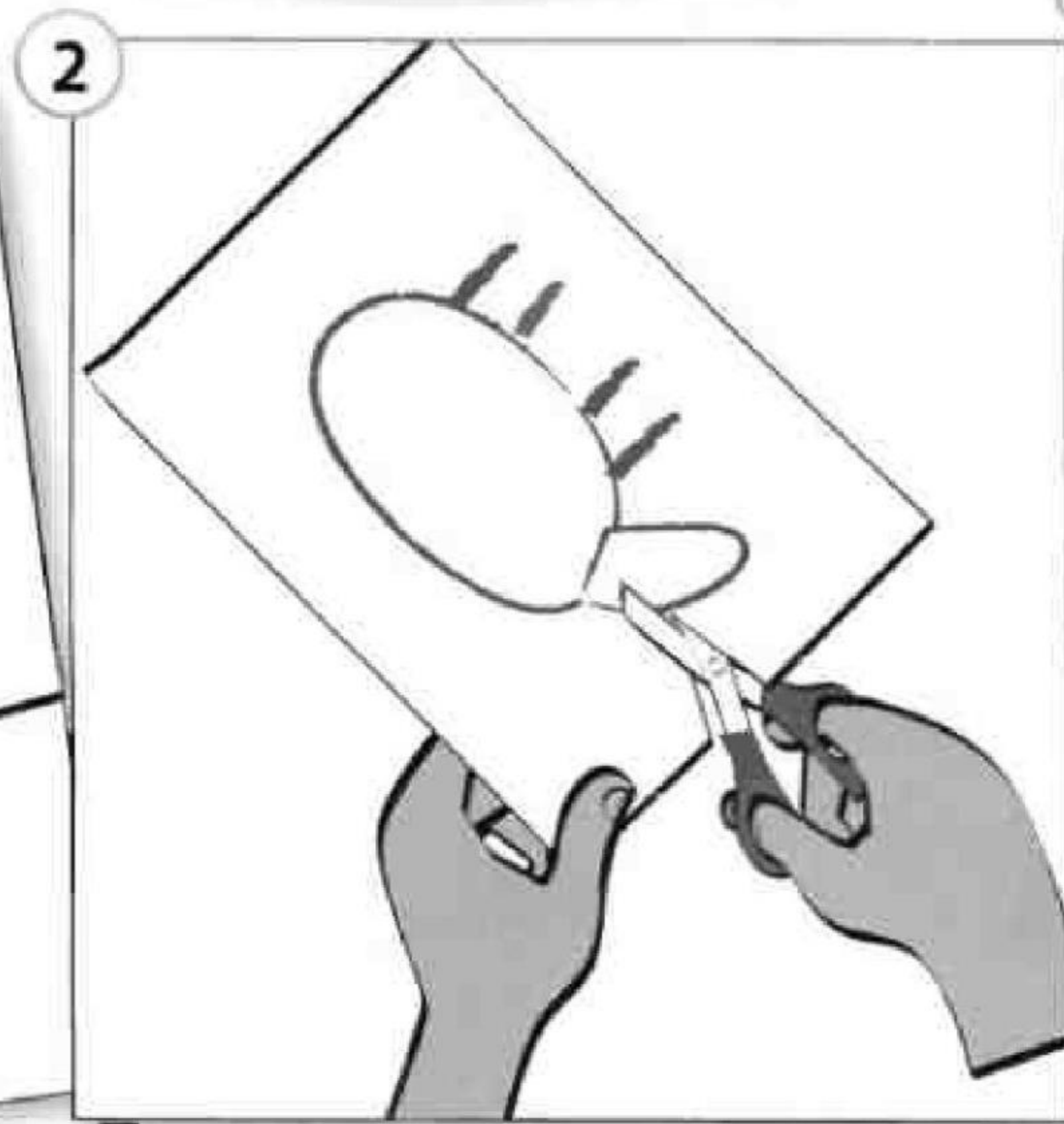
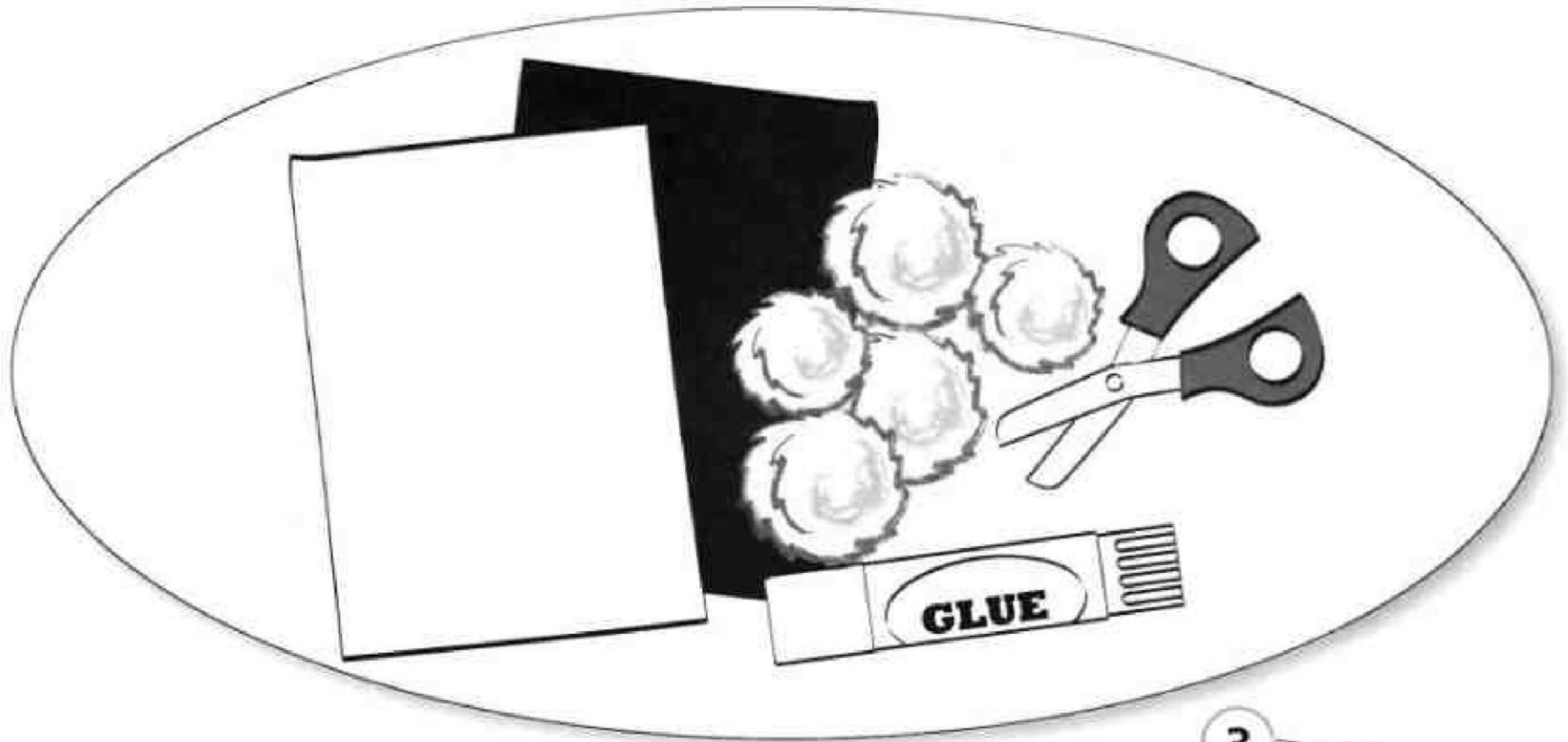

1 Say the words and trace. Colour the circles.



dog

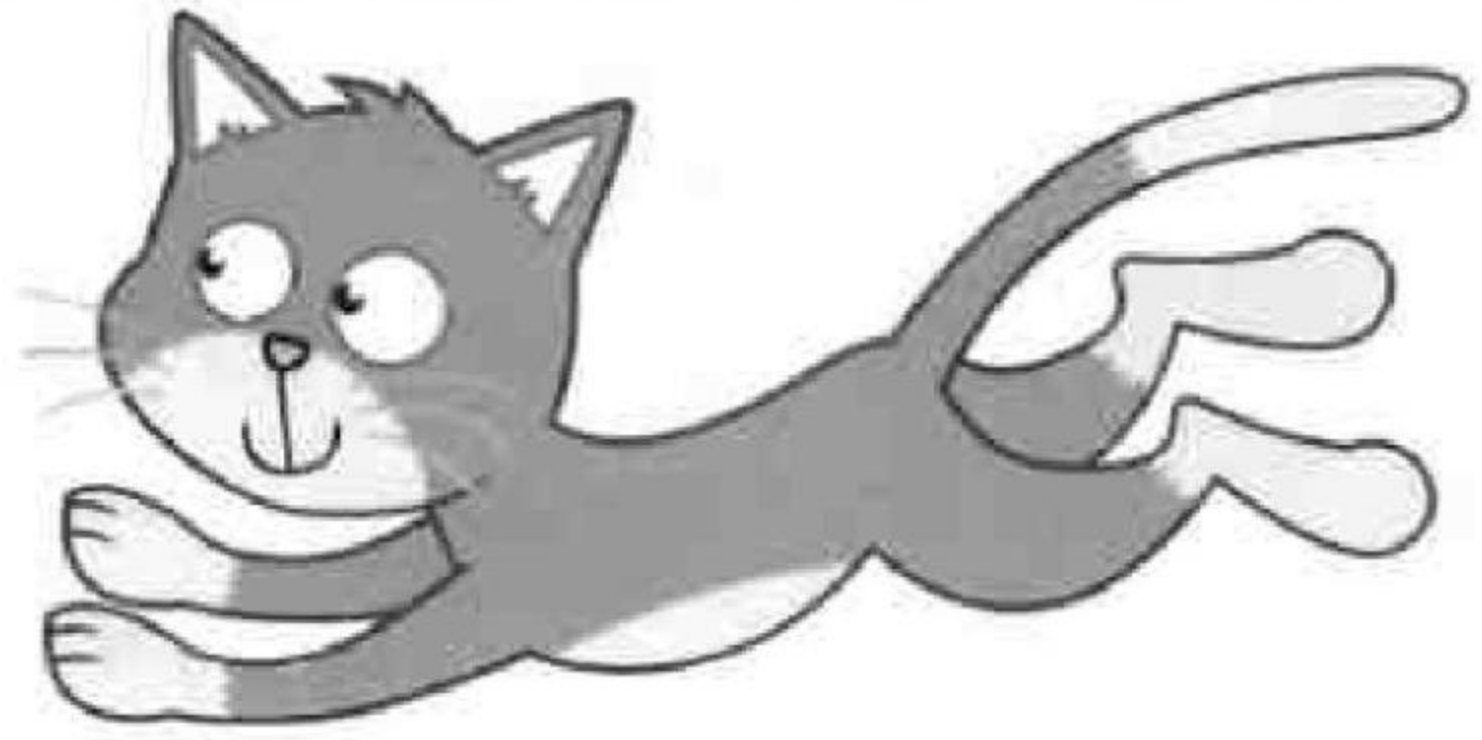

cat

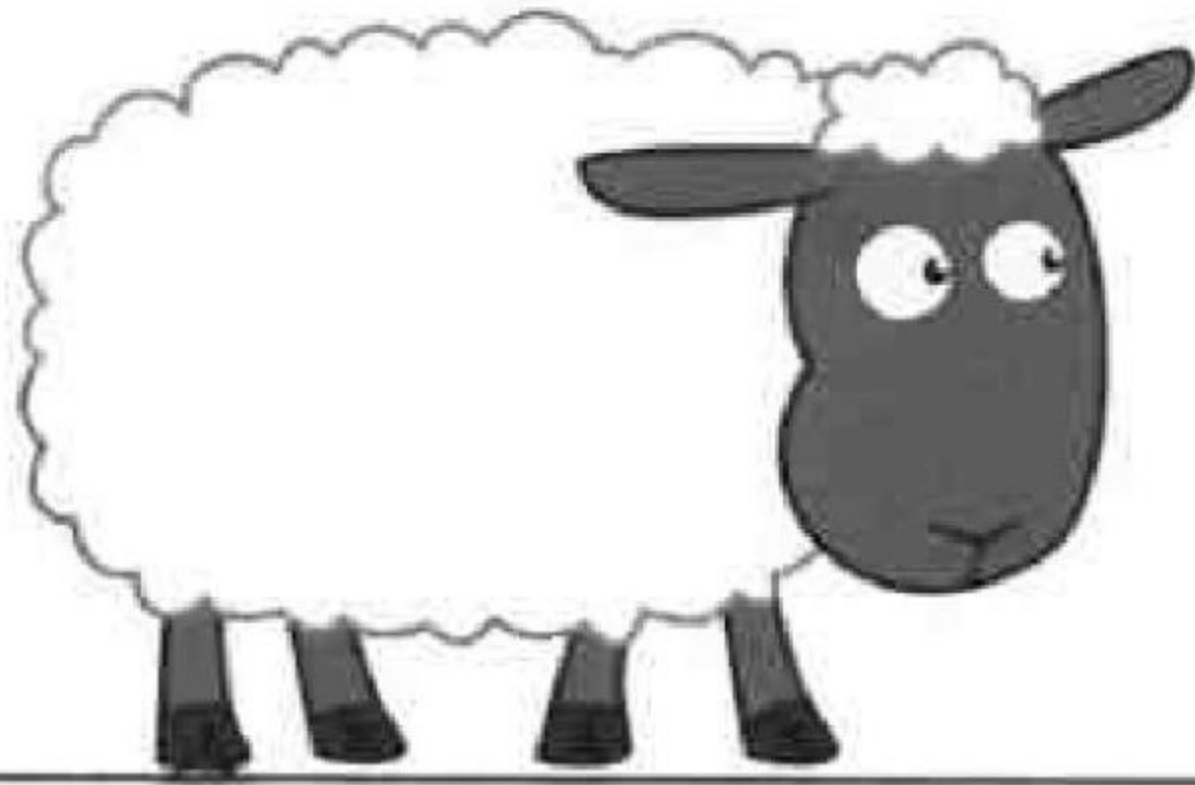

sheep

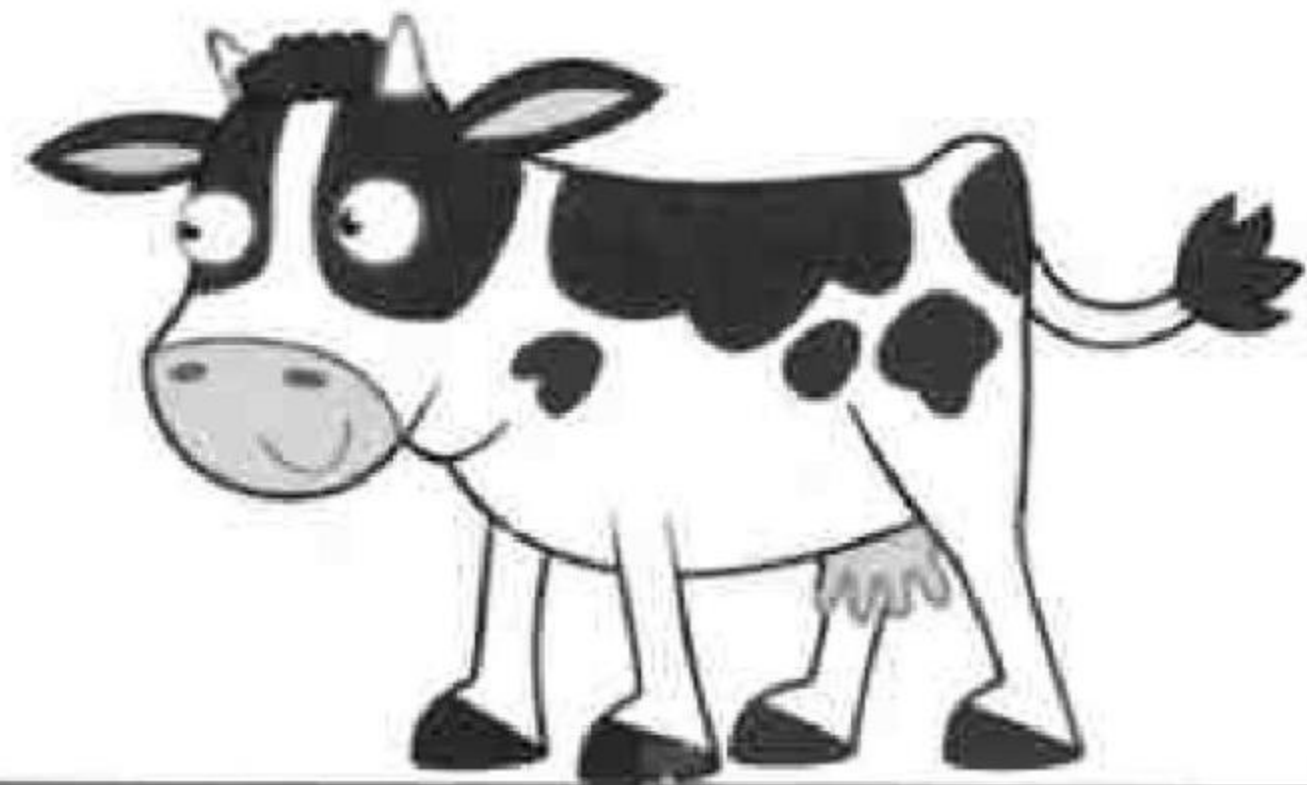

cow

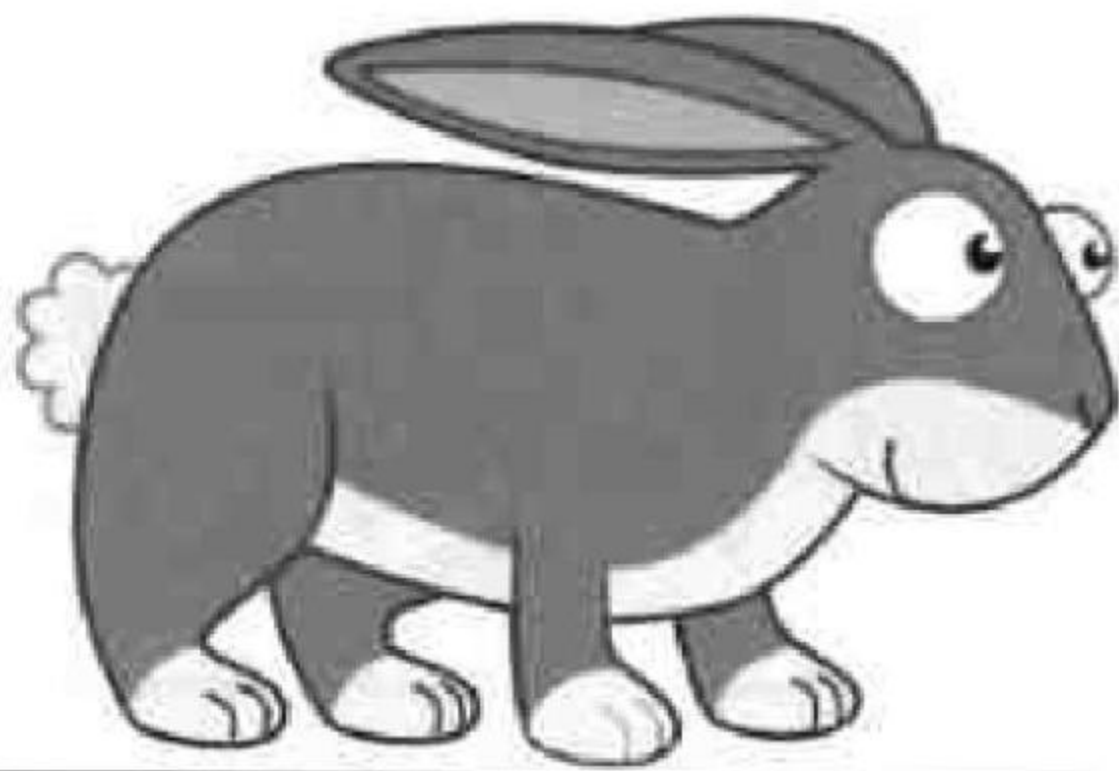
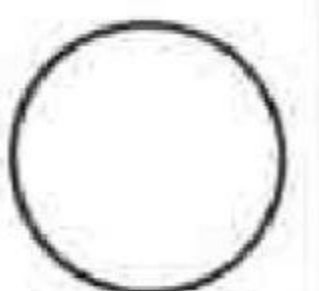

rabbit

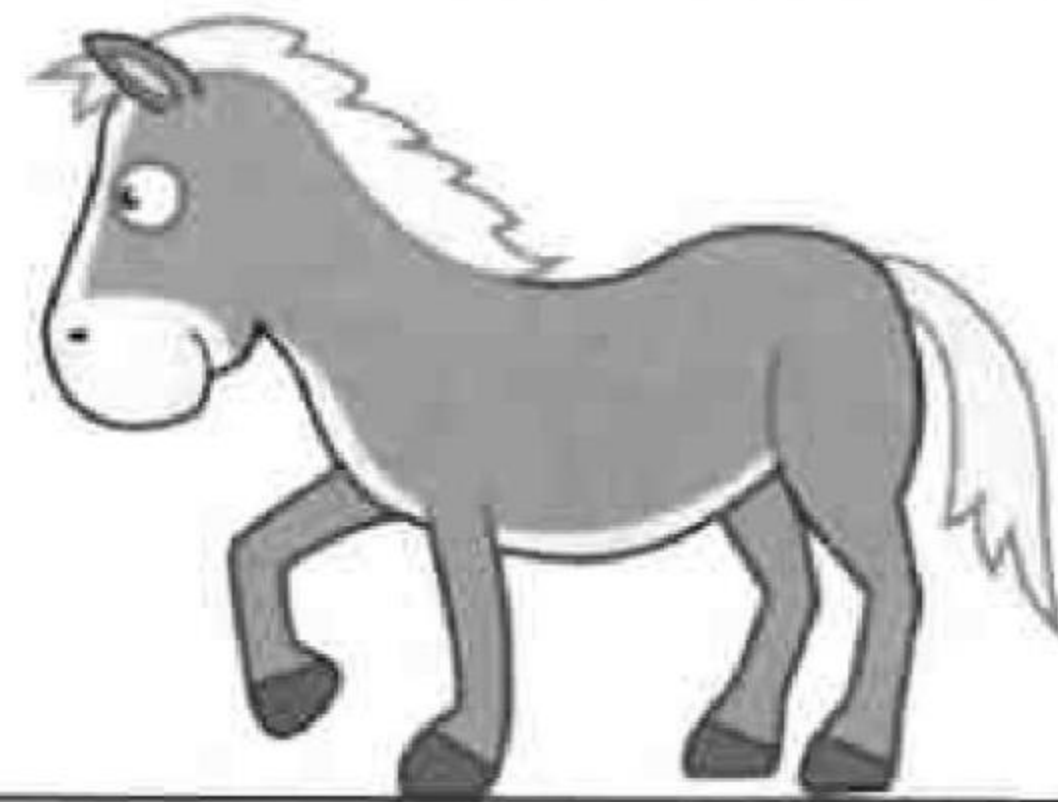
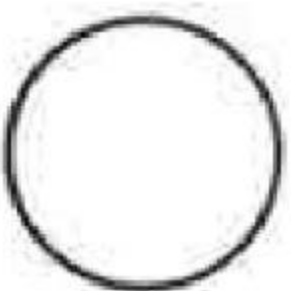

horse



2 Draw faces. 😊 😐 😞

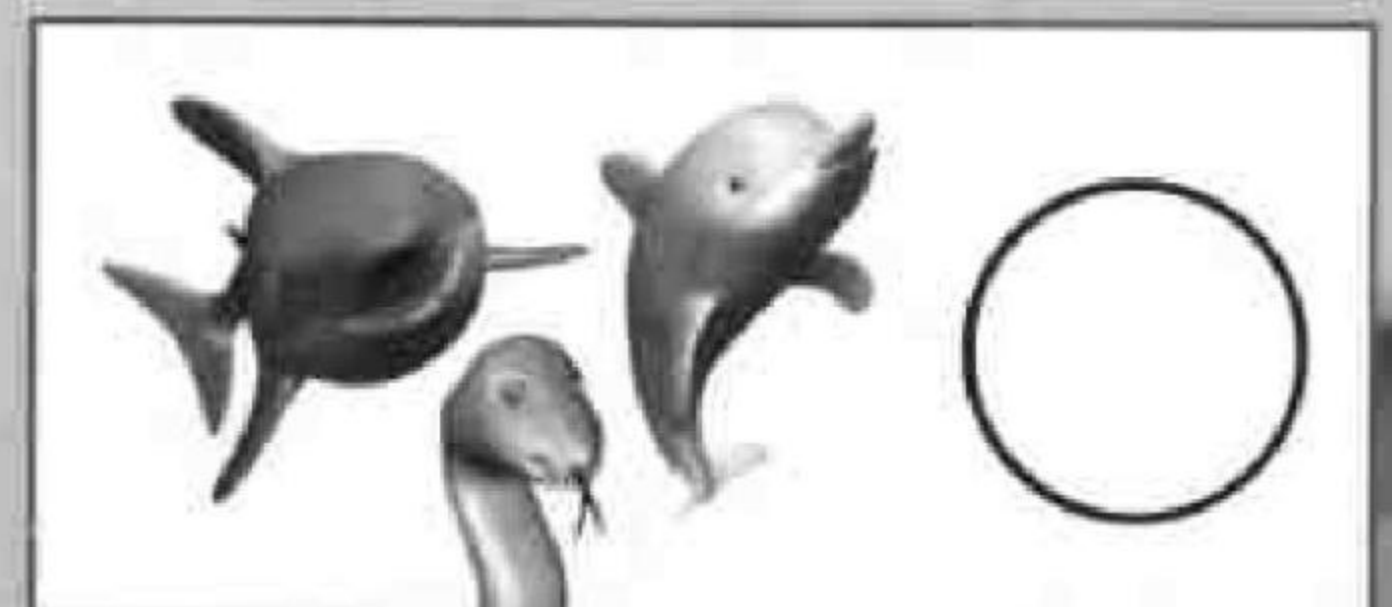
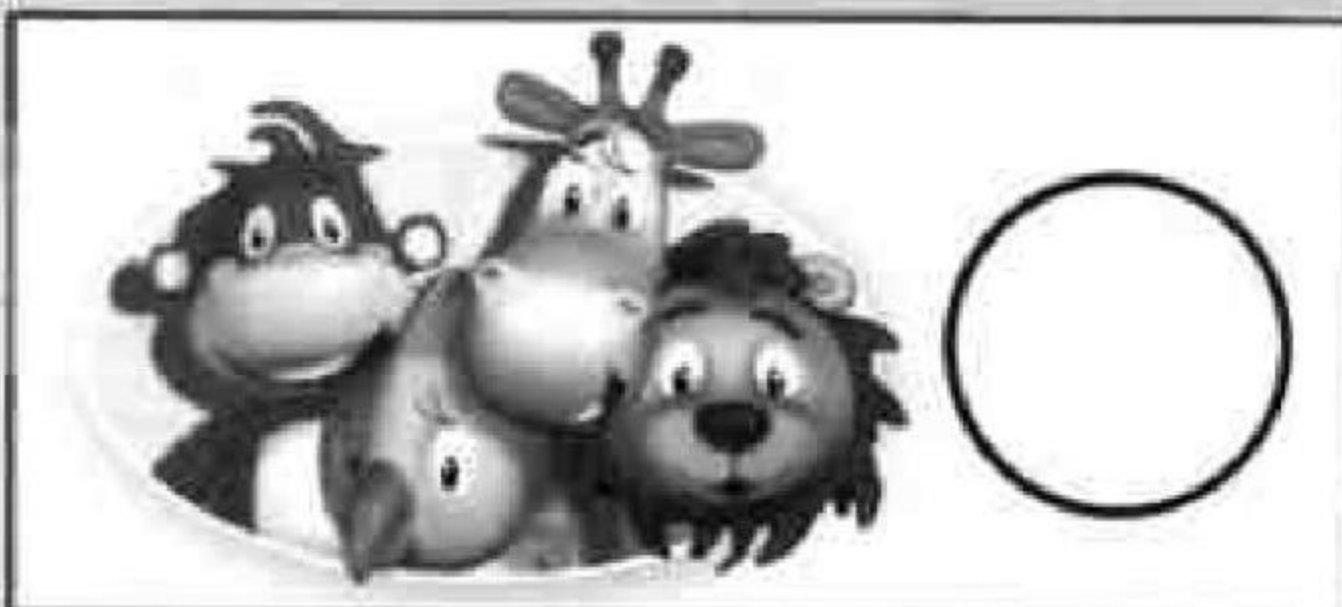
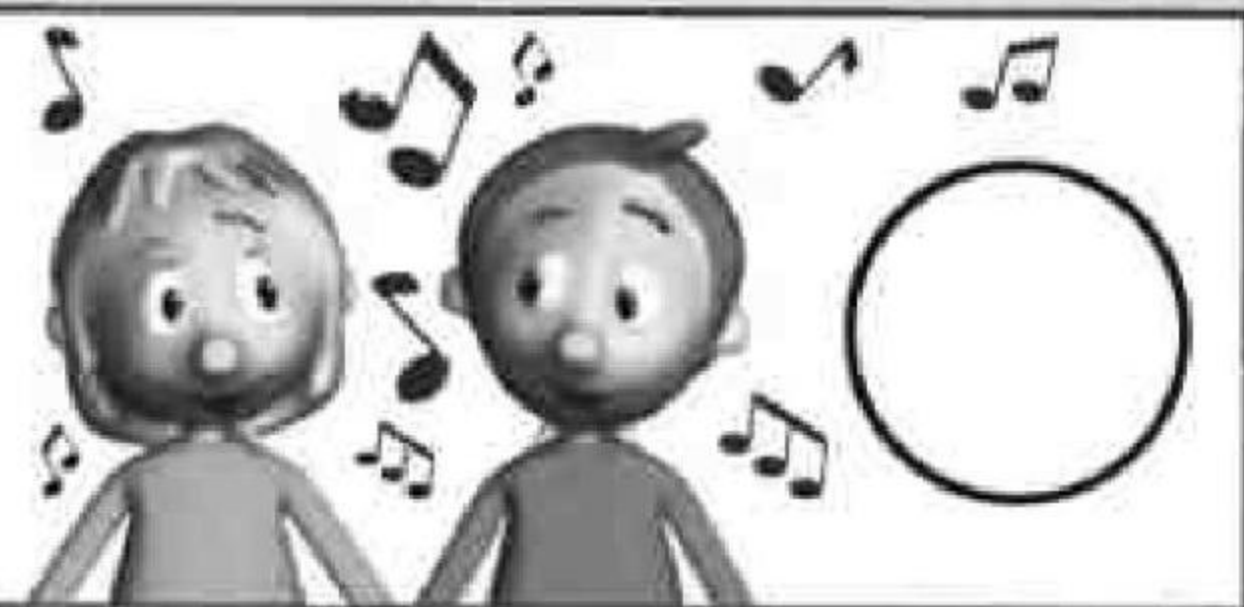

7

I'm hungry!

1

Think! Look, draw and say the words.

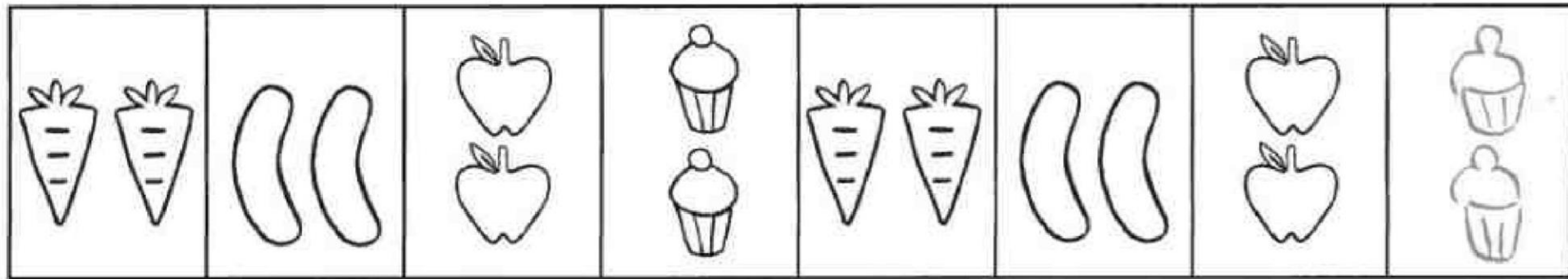

2

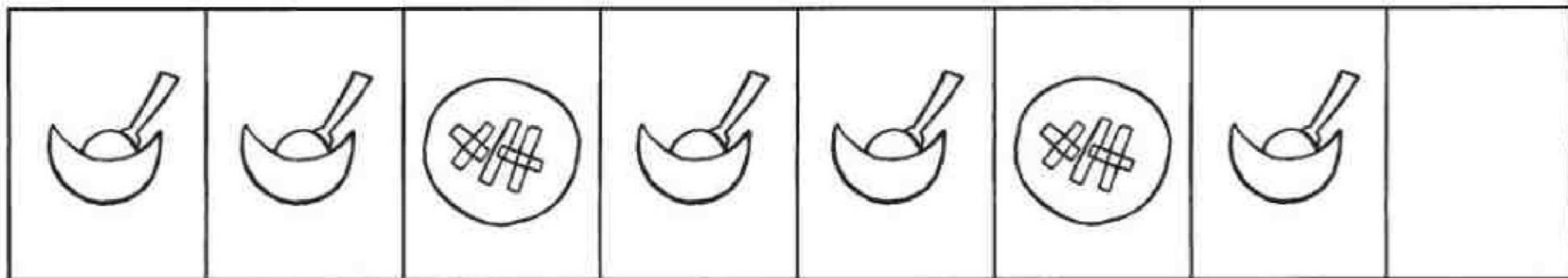

3

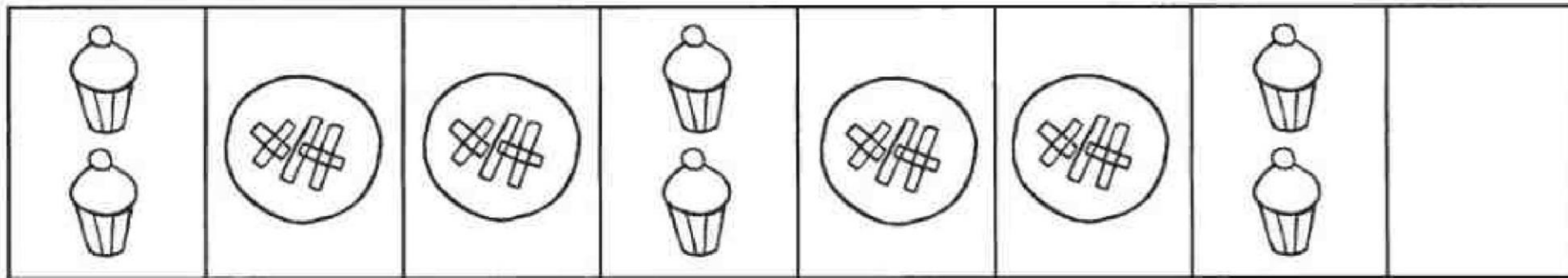

4

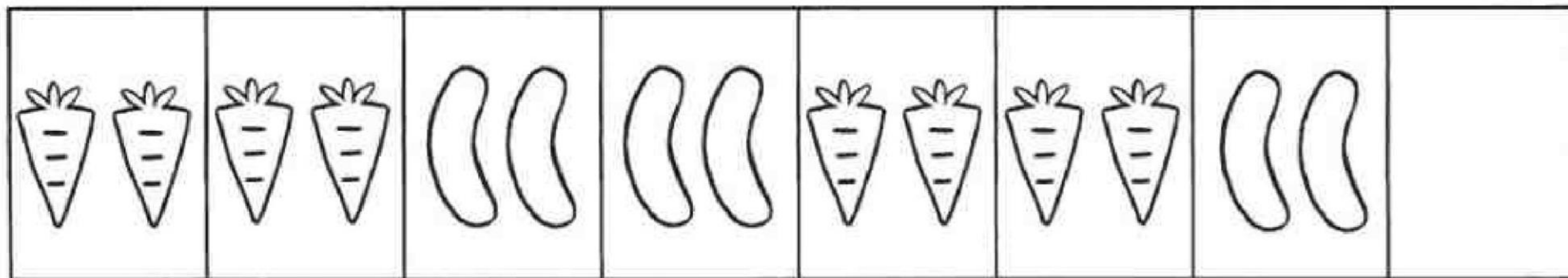

5

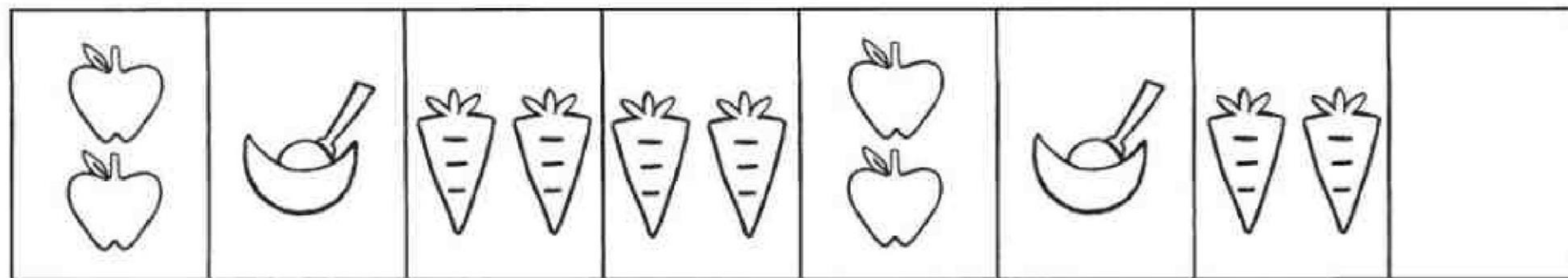

6

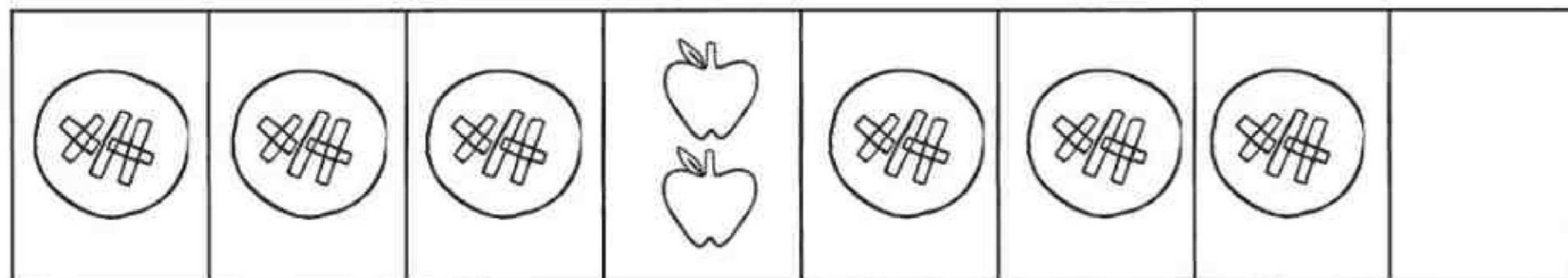

1 CD2
28

Listen and match.

1

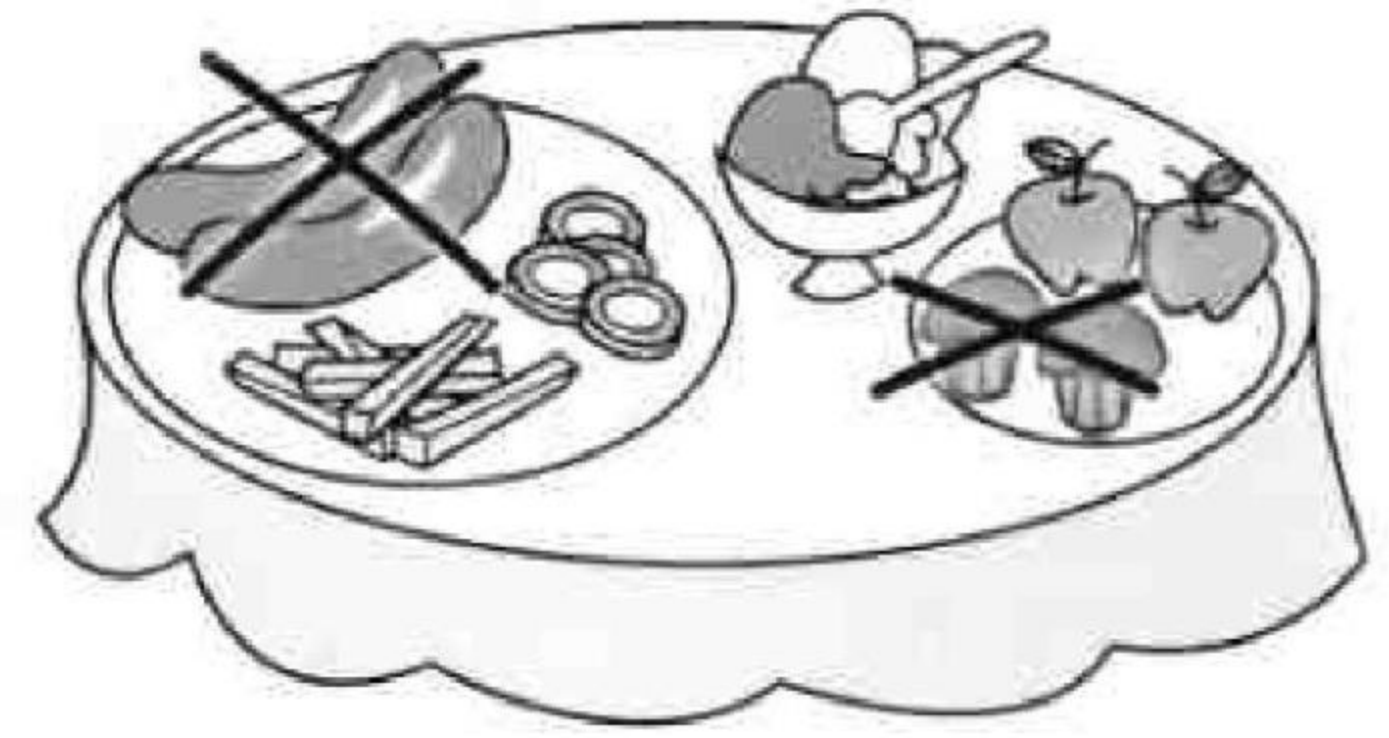

2

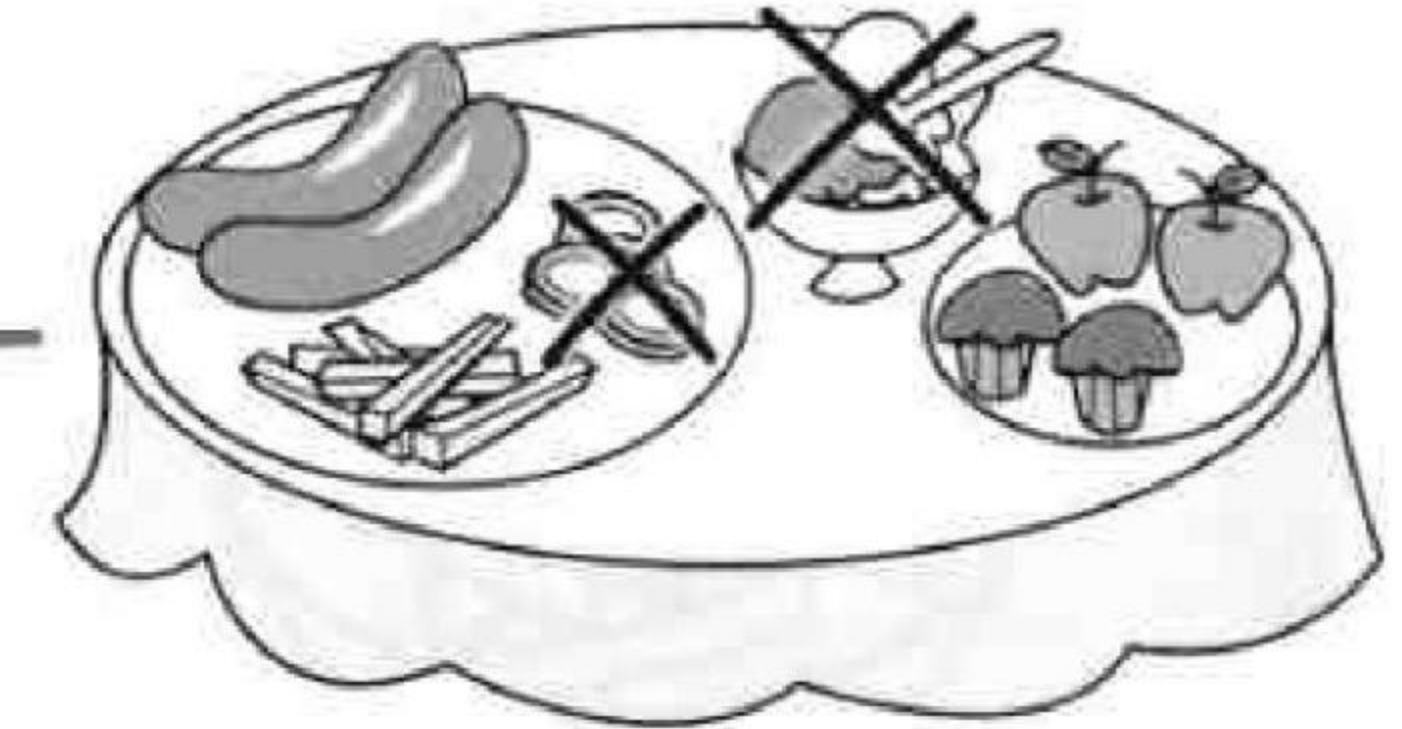

3

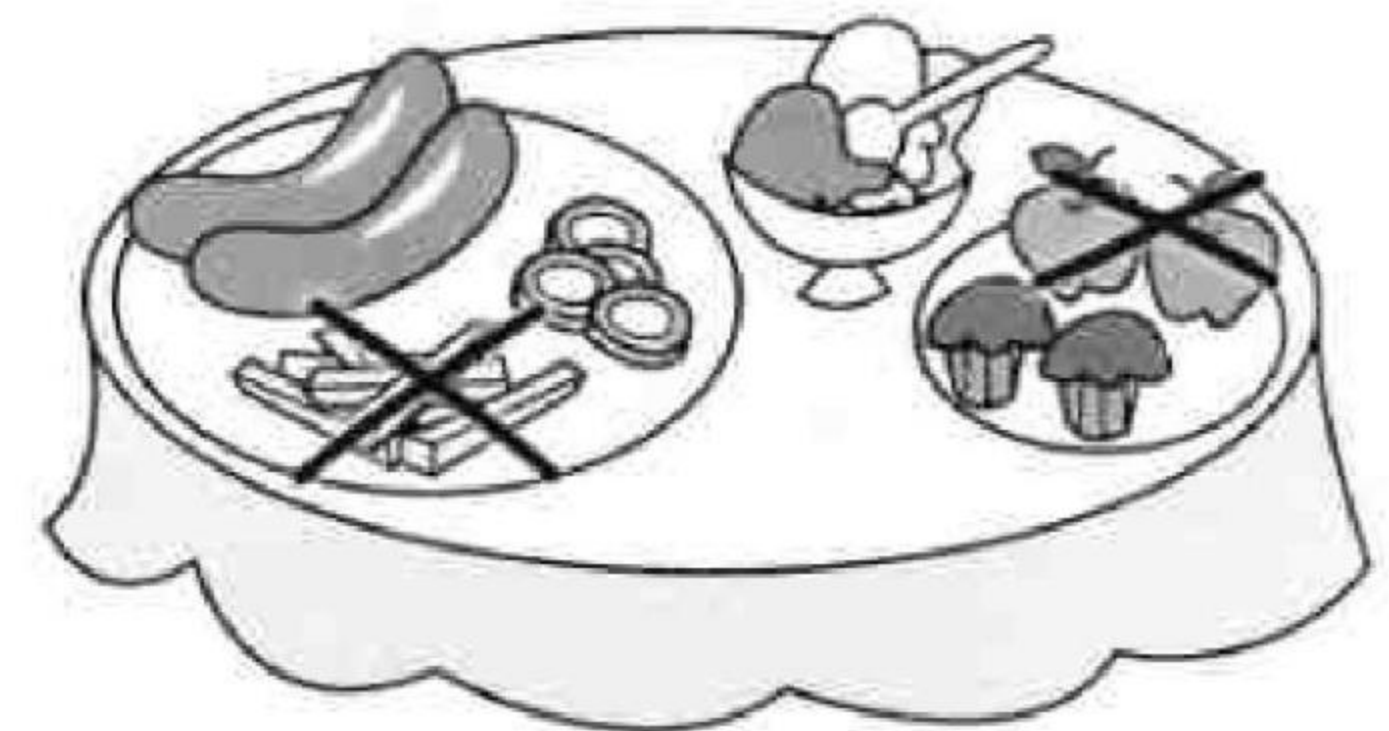

4

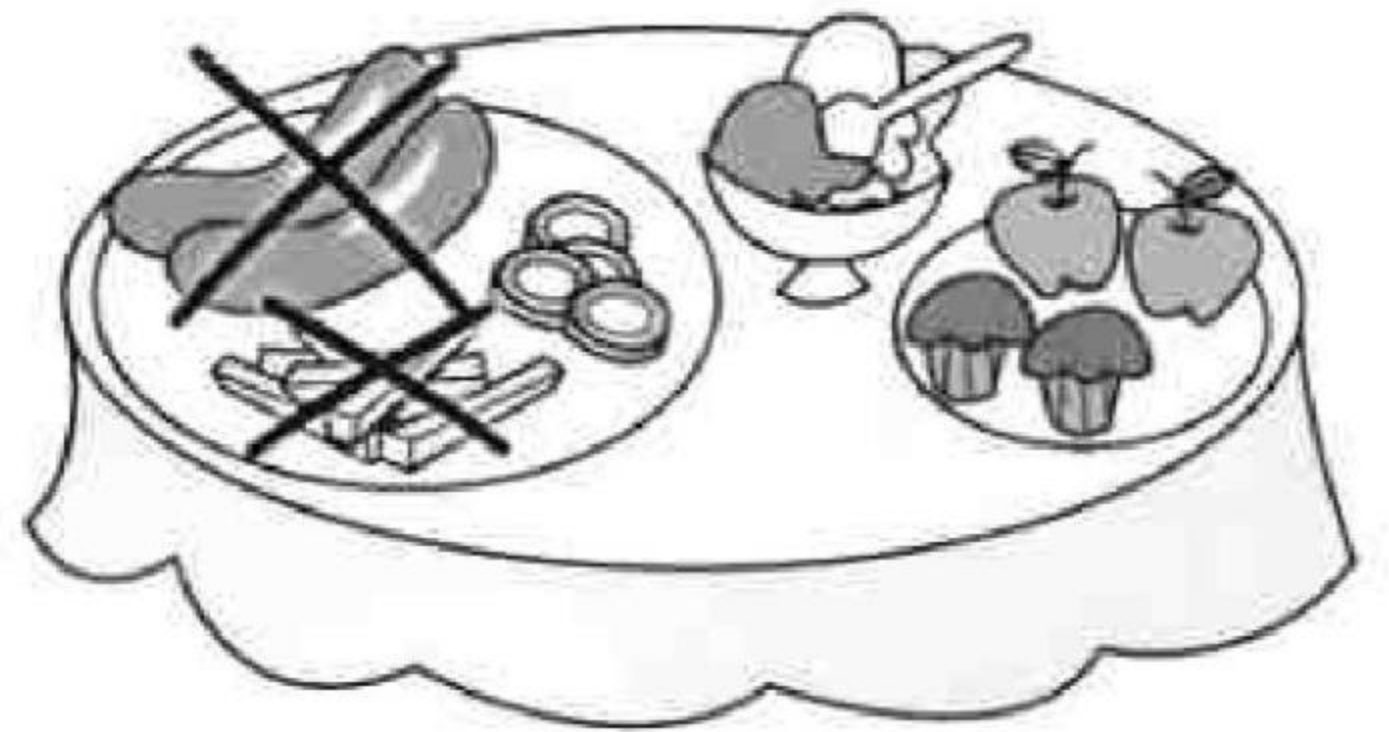
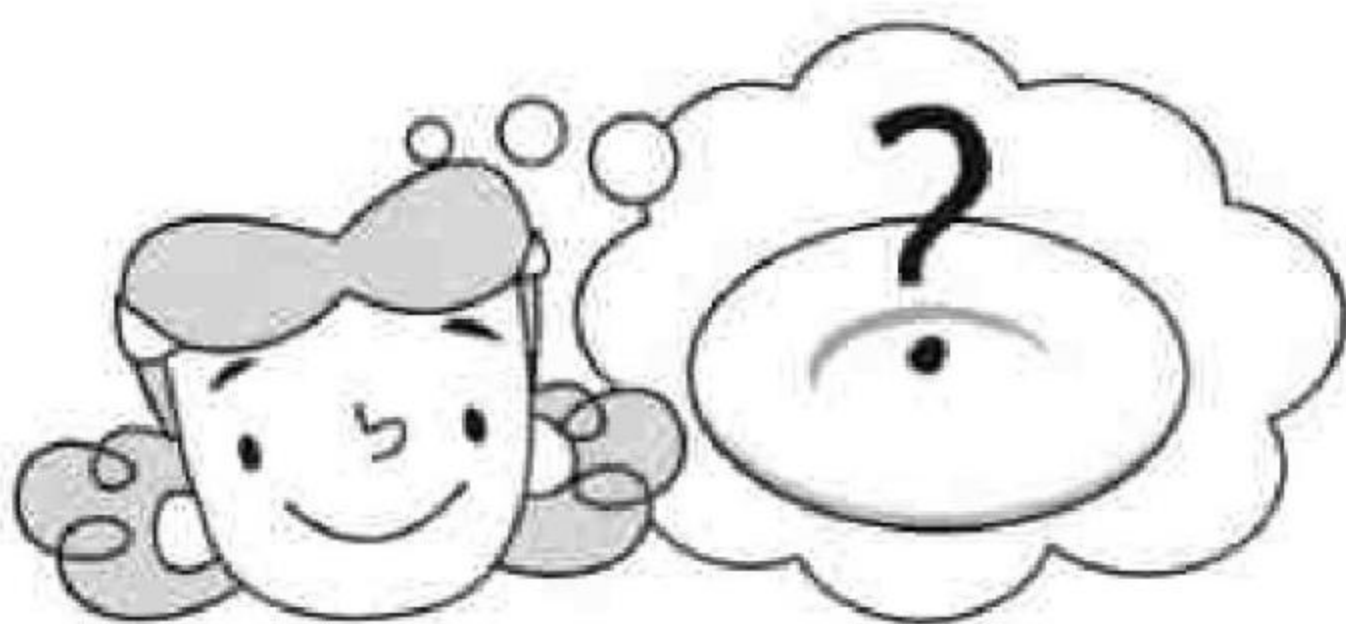

2

Draw your favourite food.

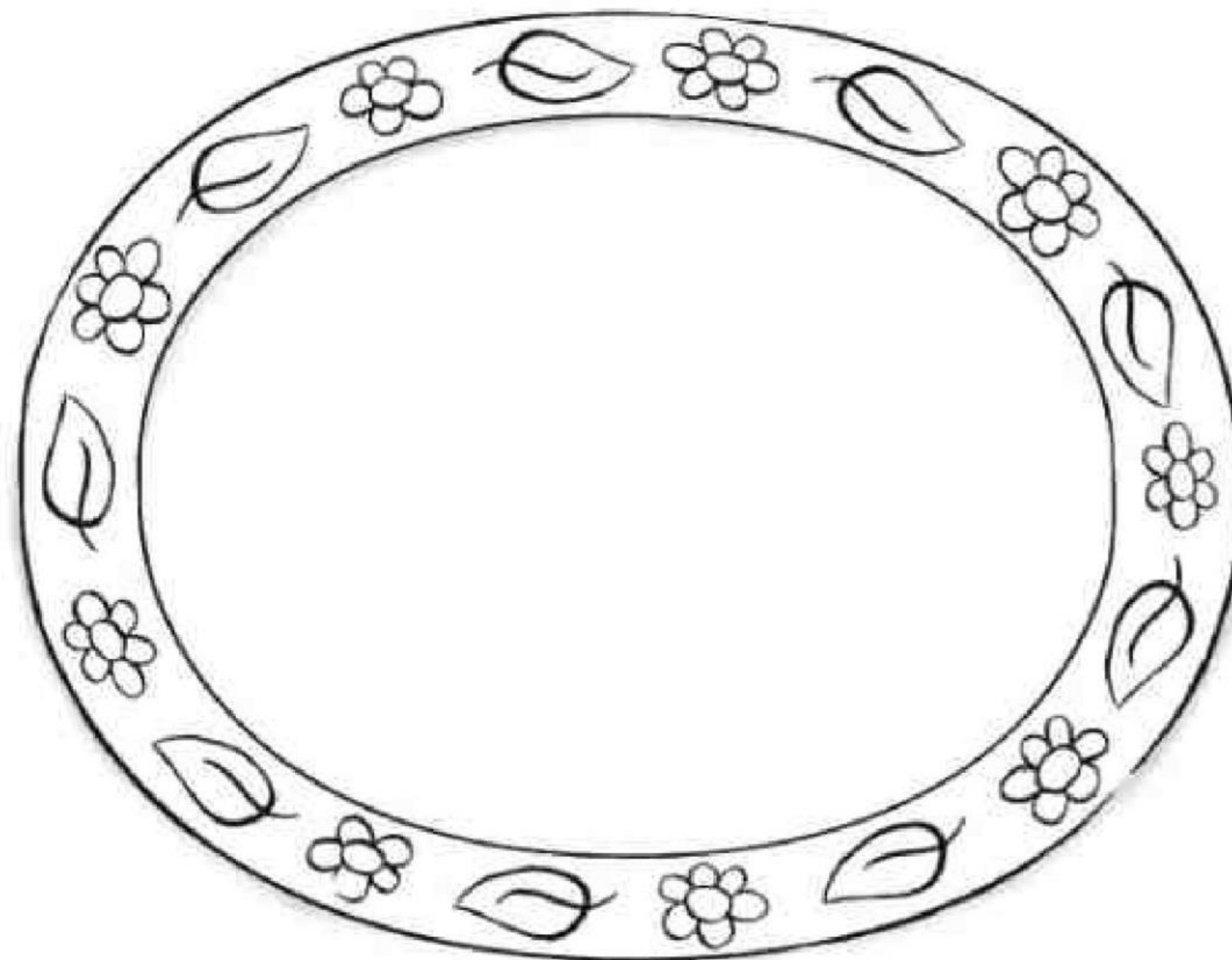

1

Draw.

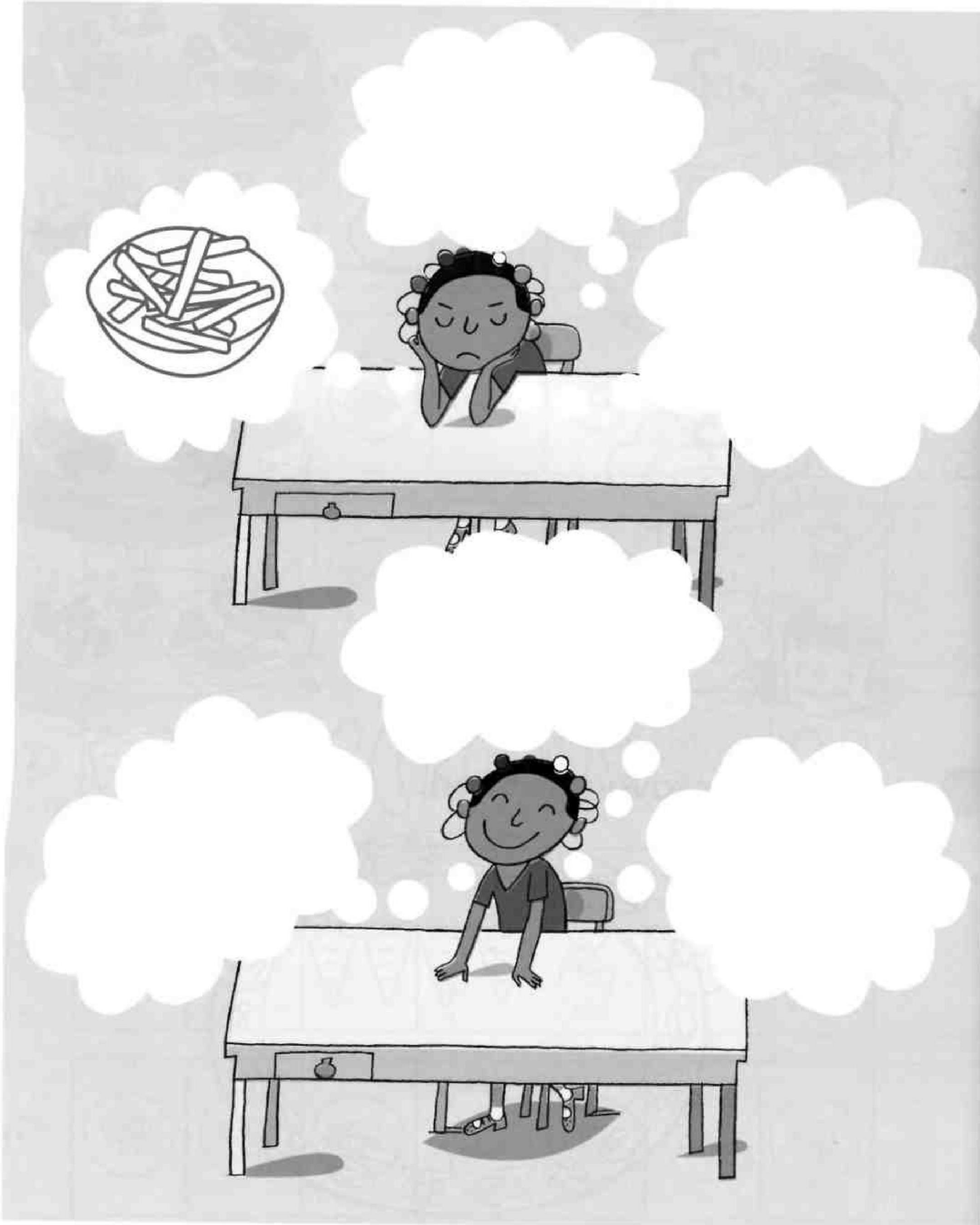

1 Draw faces. 😊 ☹️ Tell your friend and draw.

chips



sausages



cakes



carrots

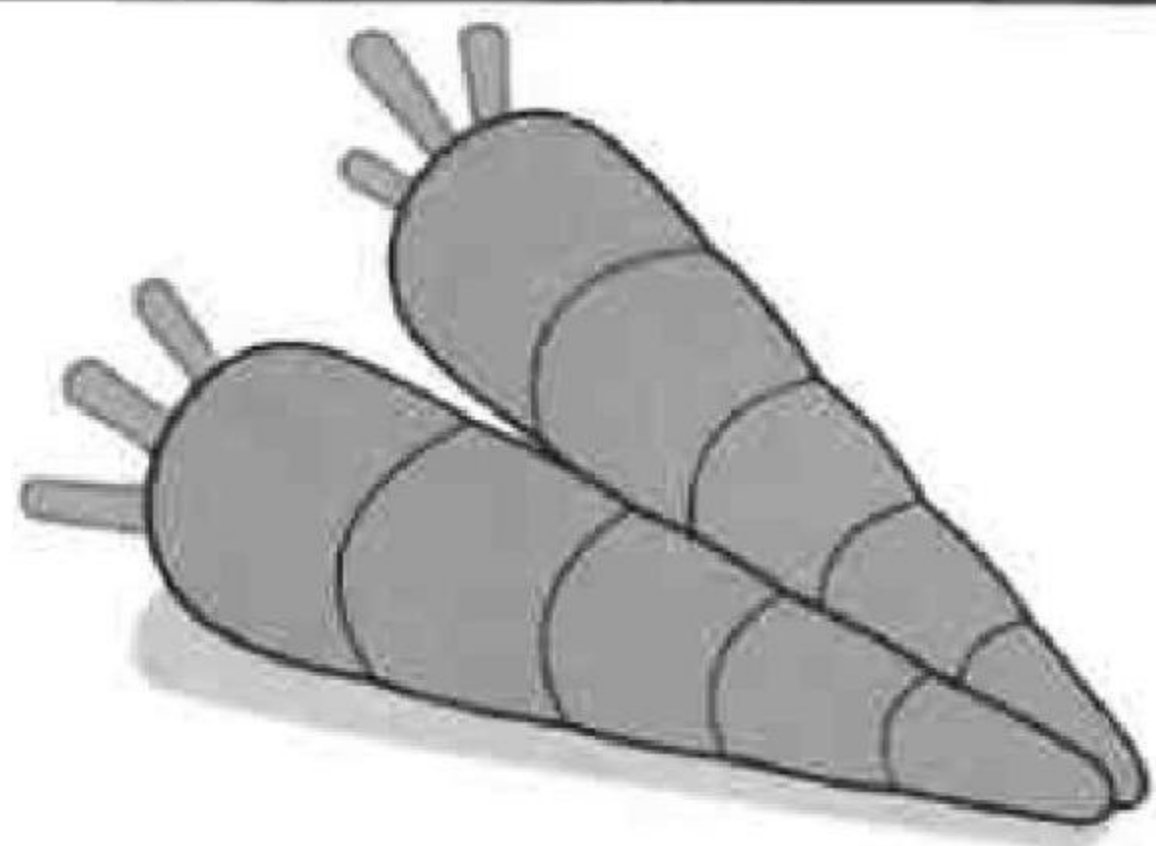

ice cream

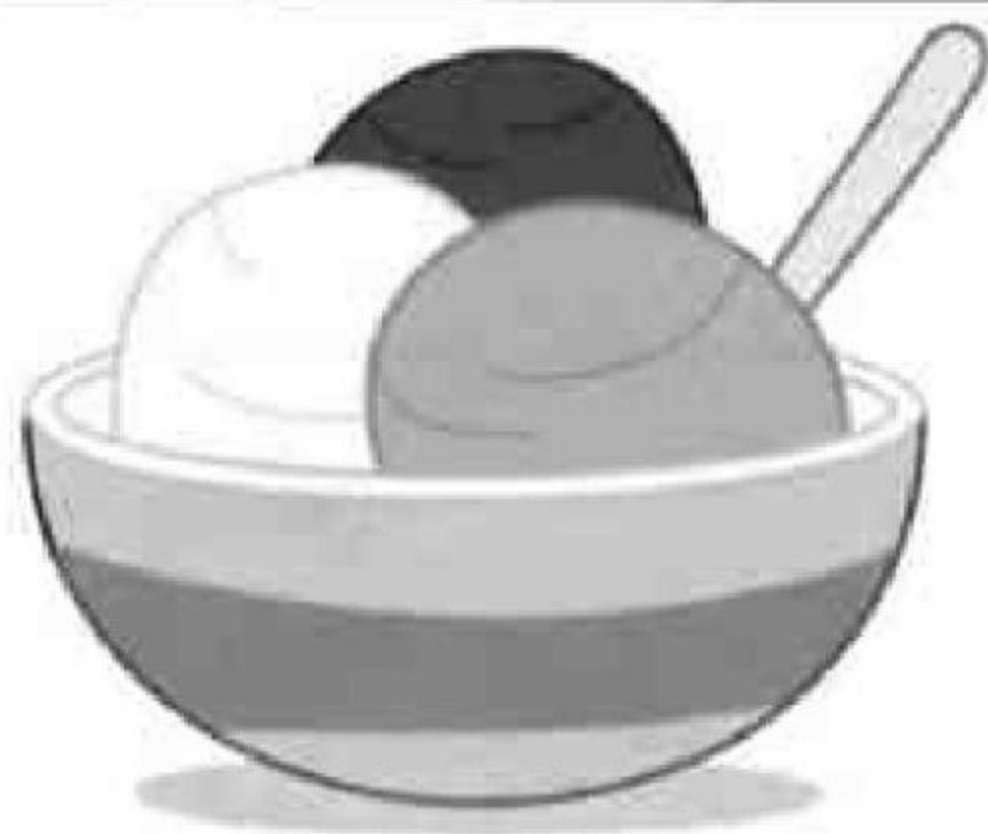

apples

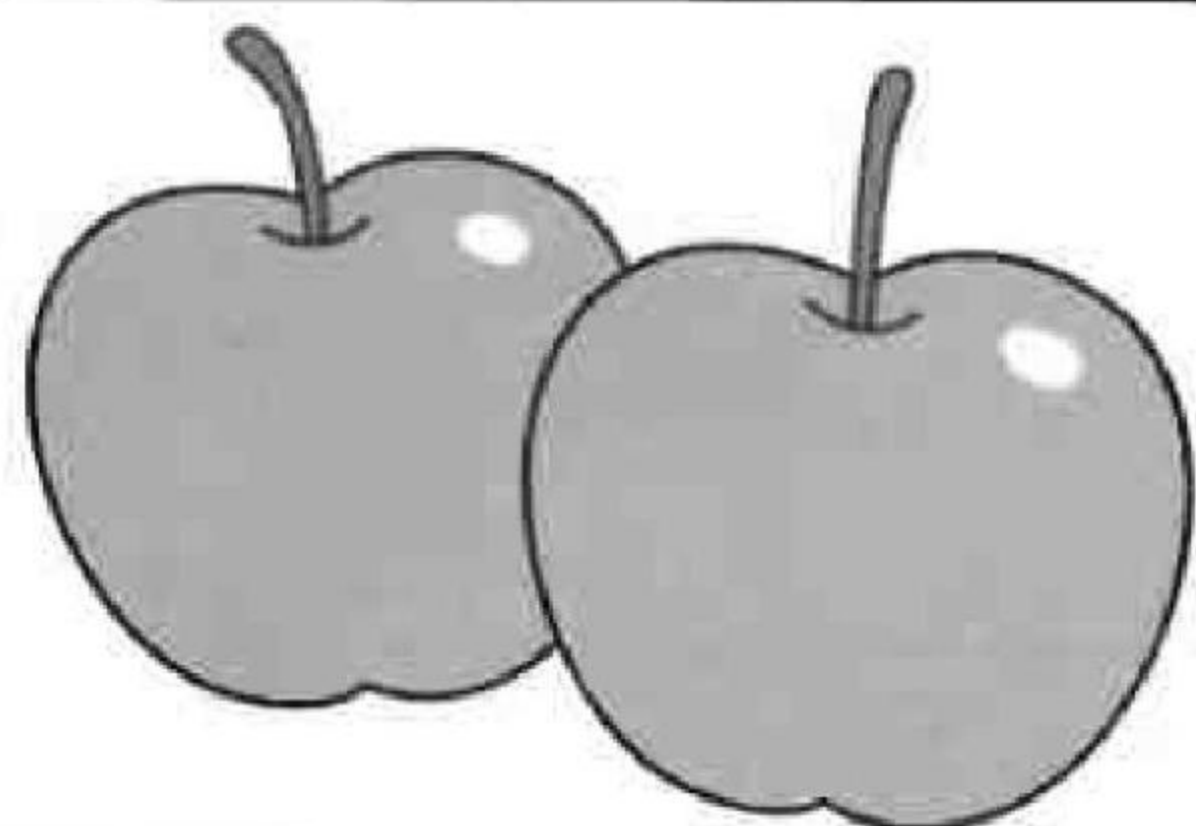

Listen and trace.

1



2

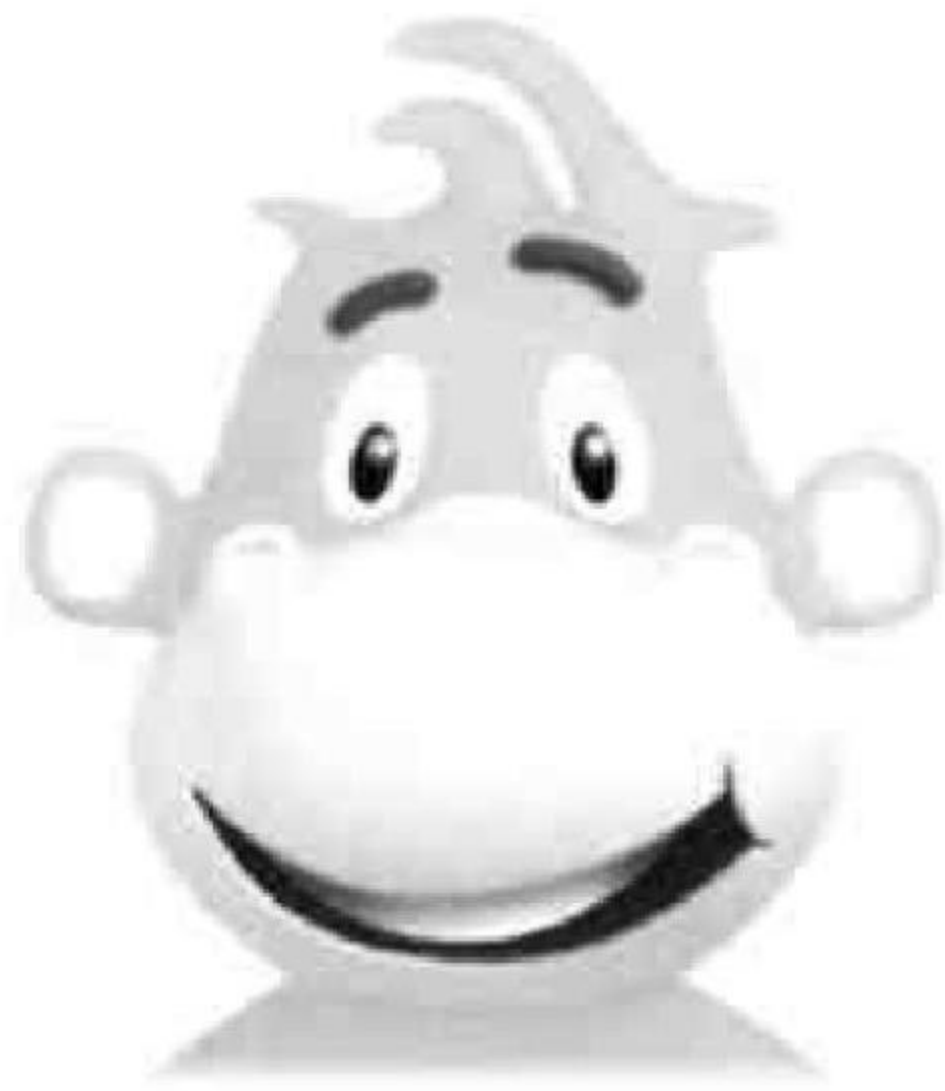

3



4



1 Think! Look and colour.



1

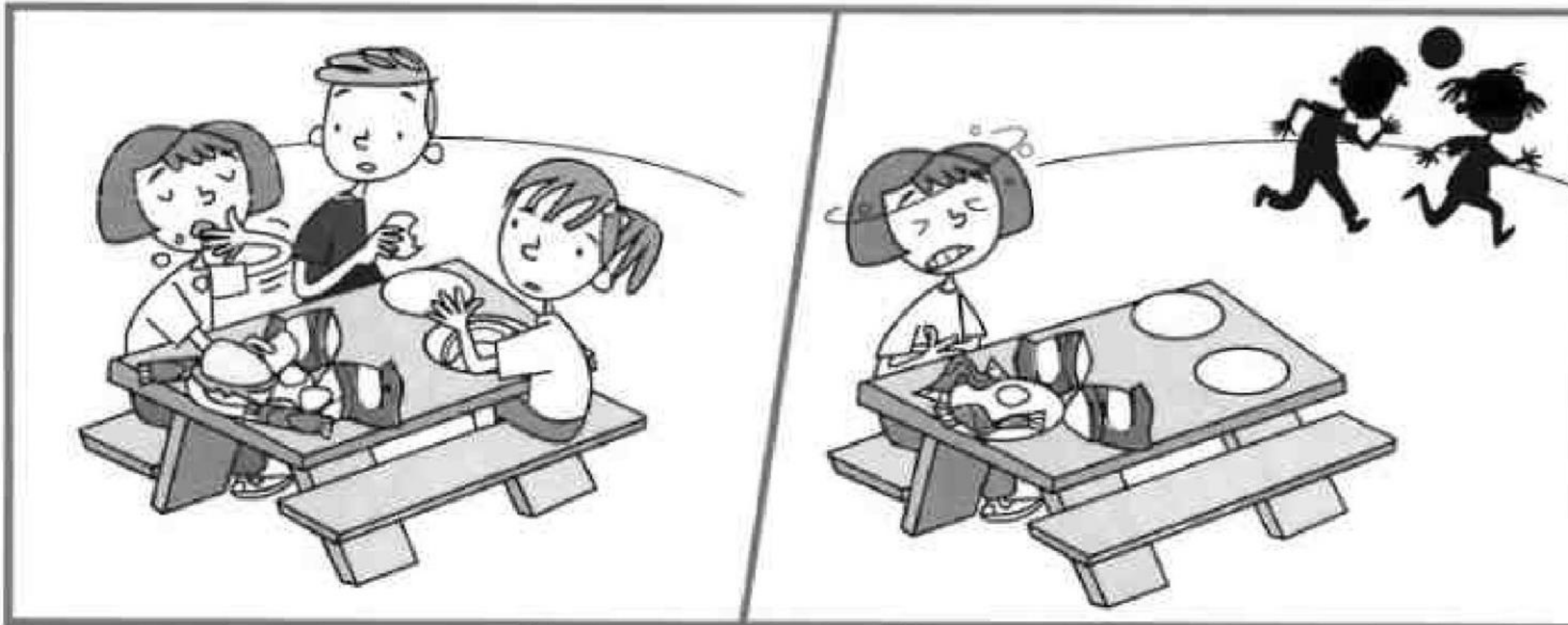

2

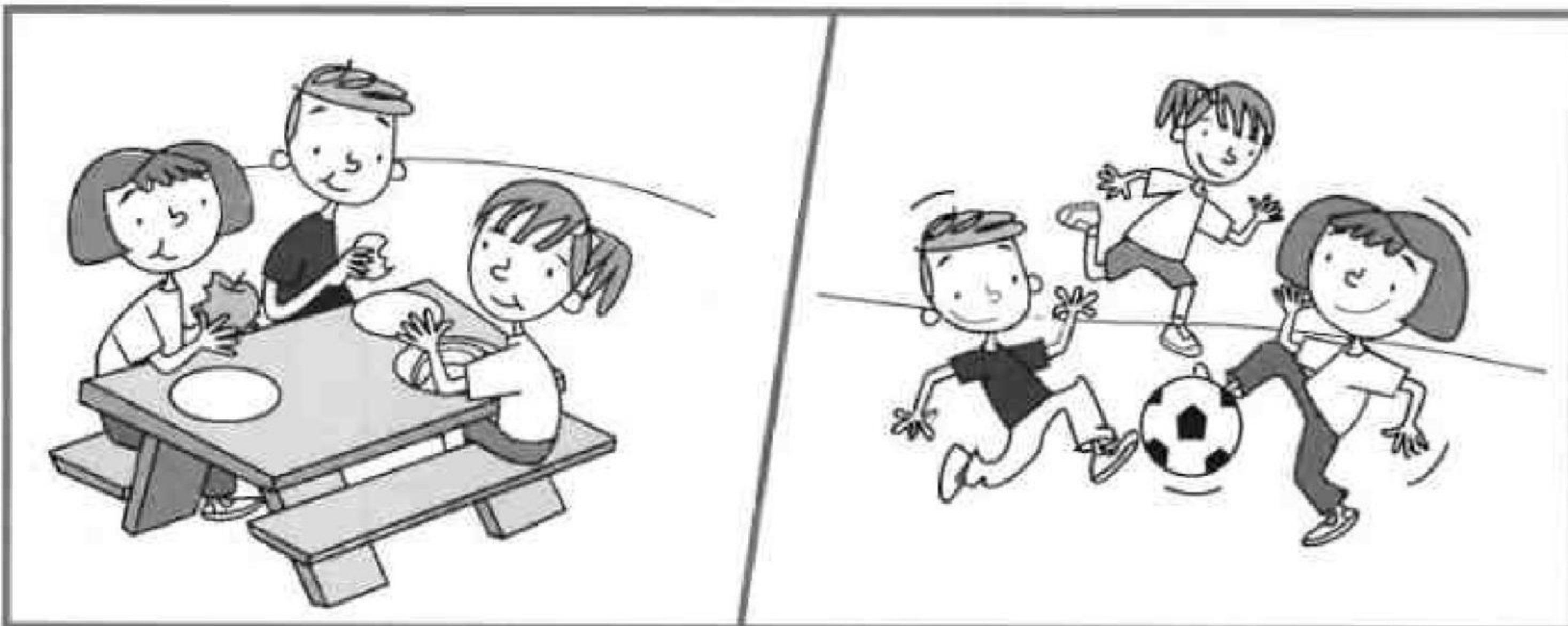

1 Draw lines. Describe the meals.

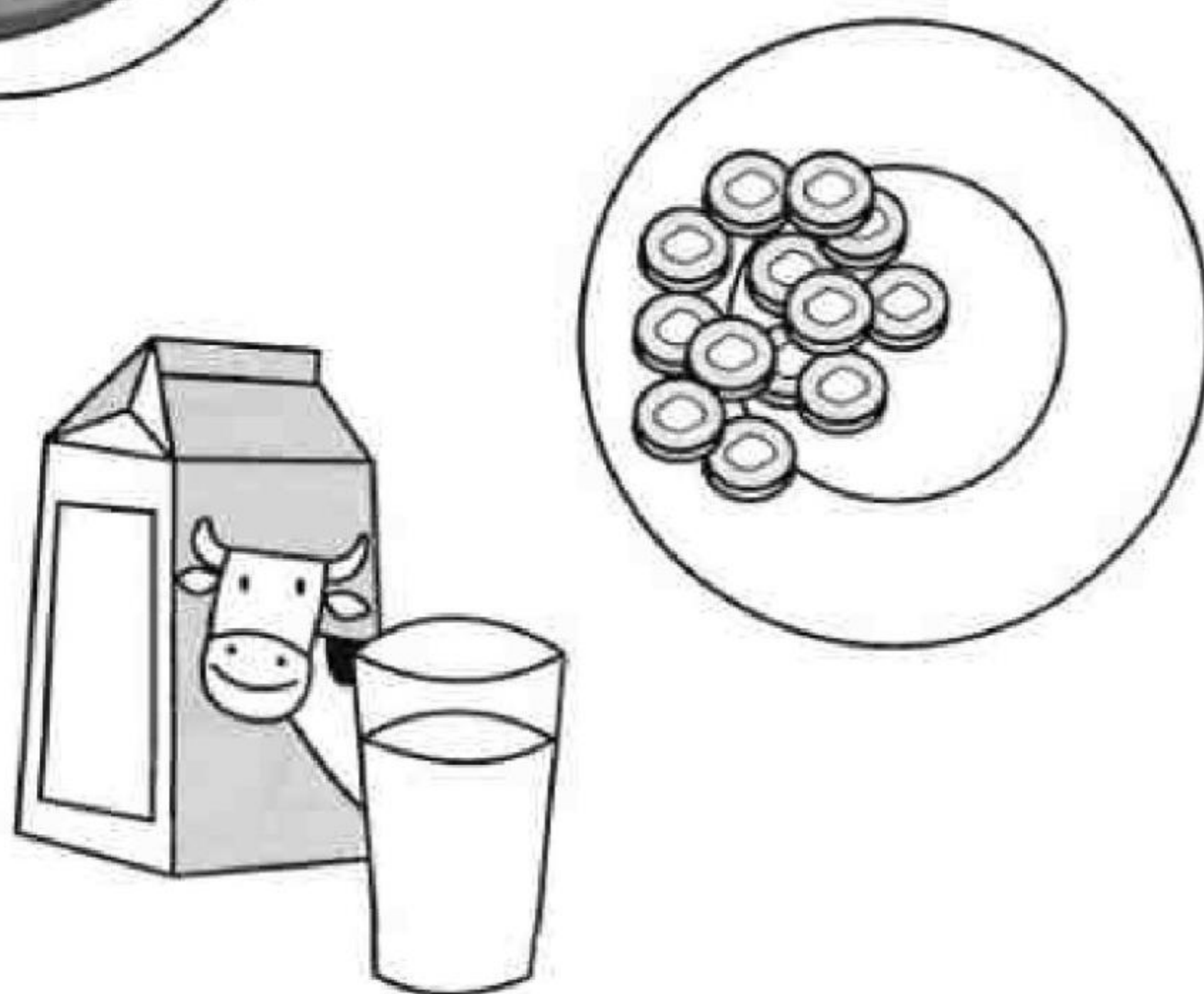
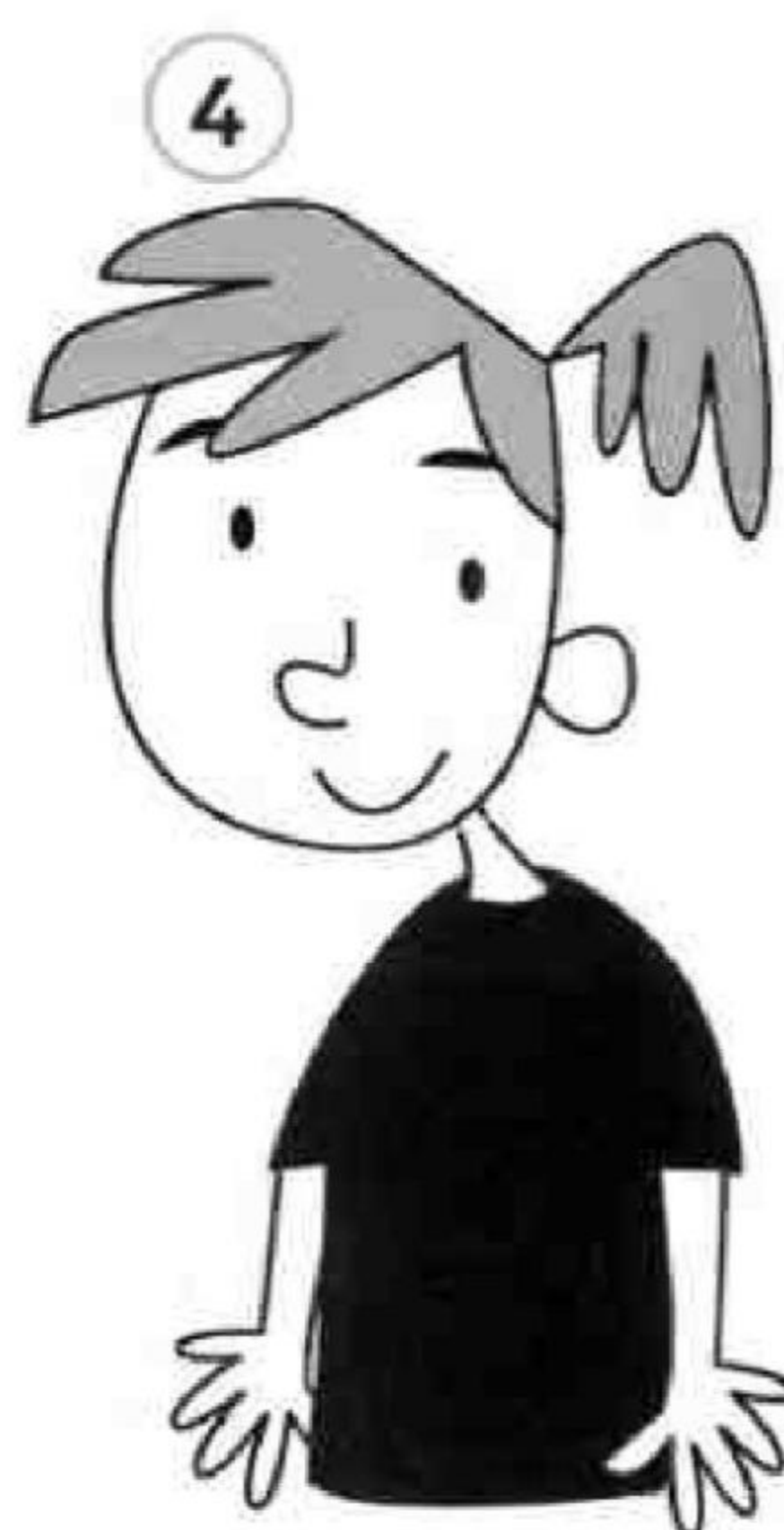
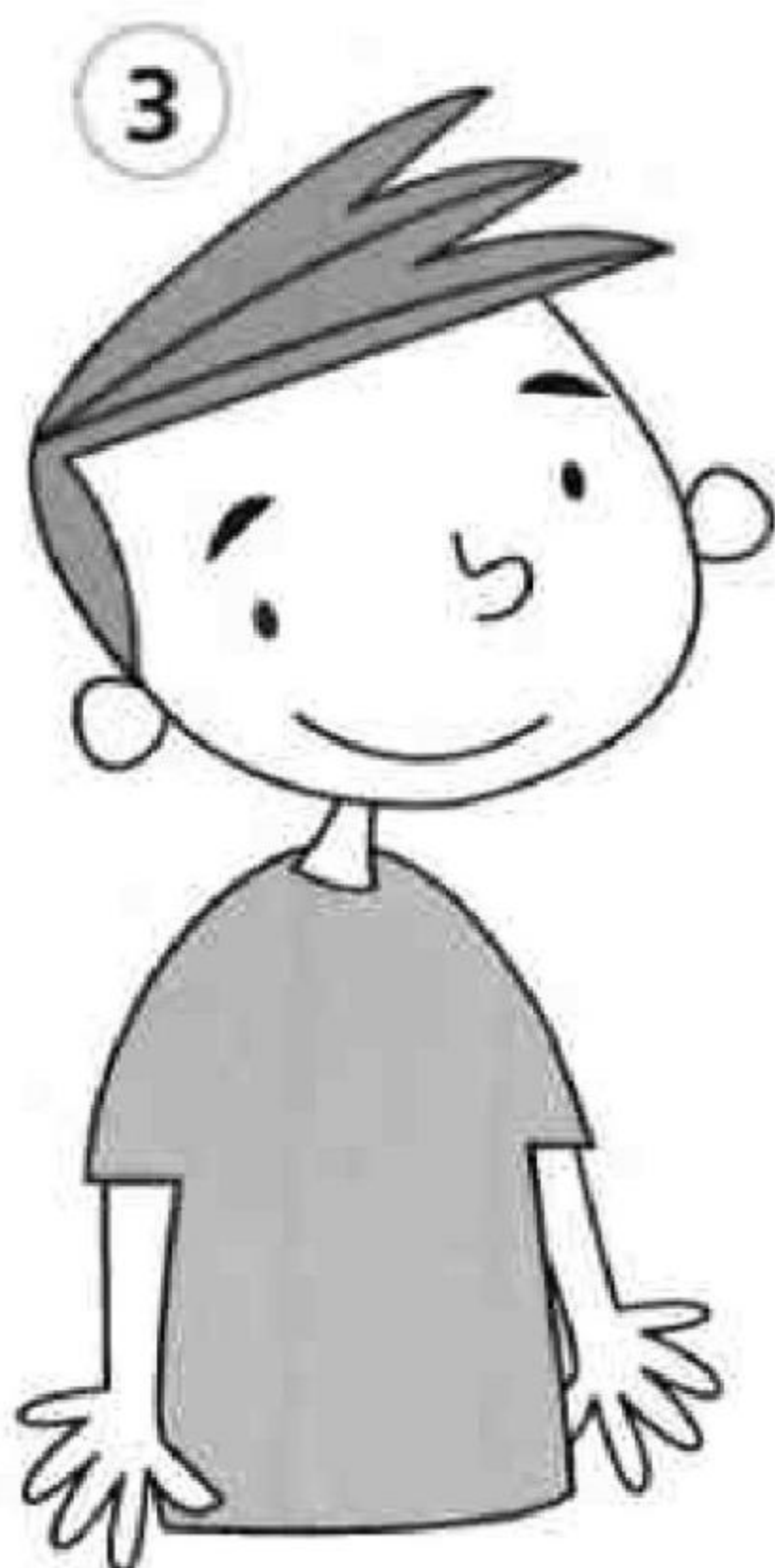
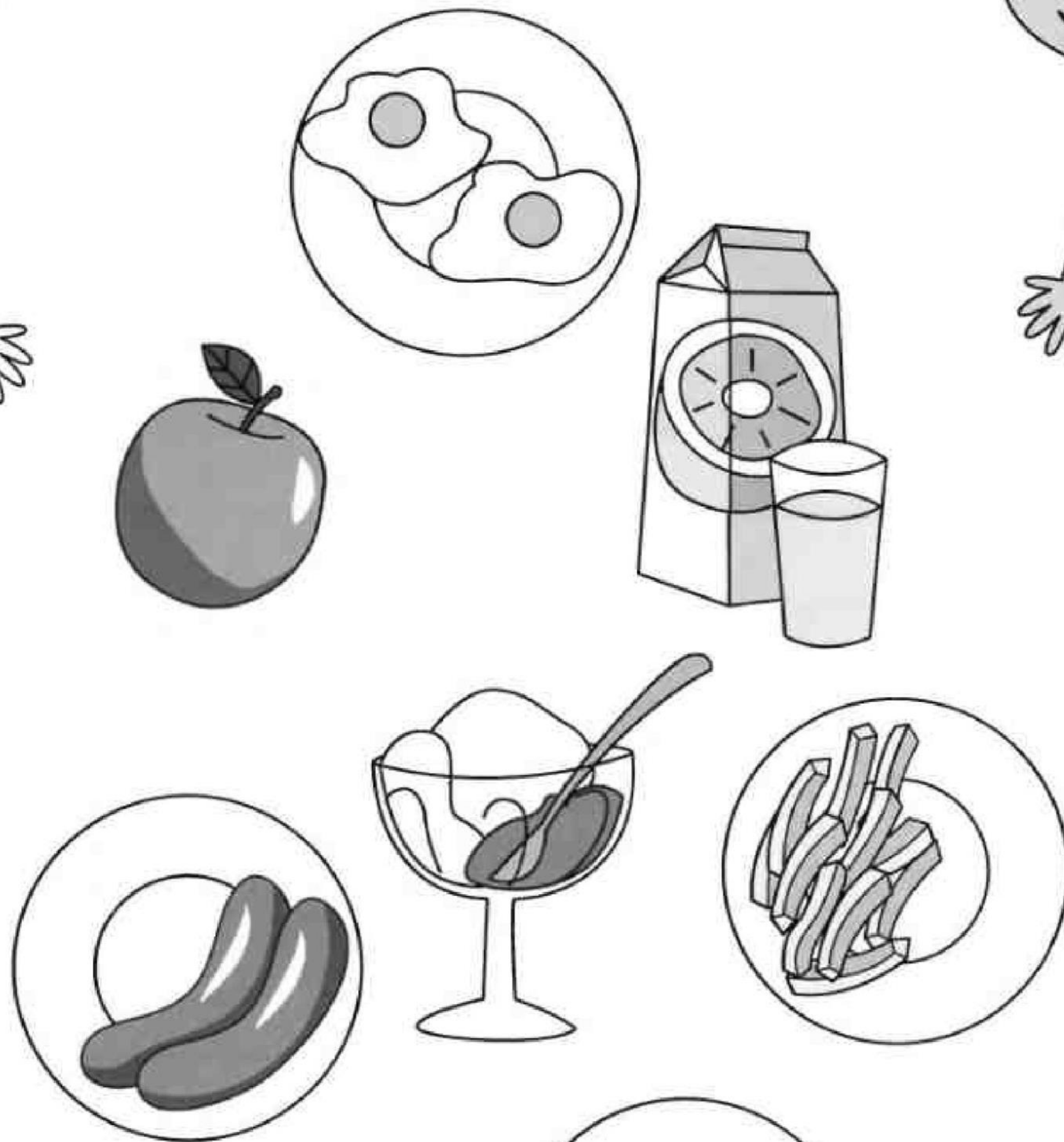
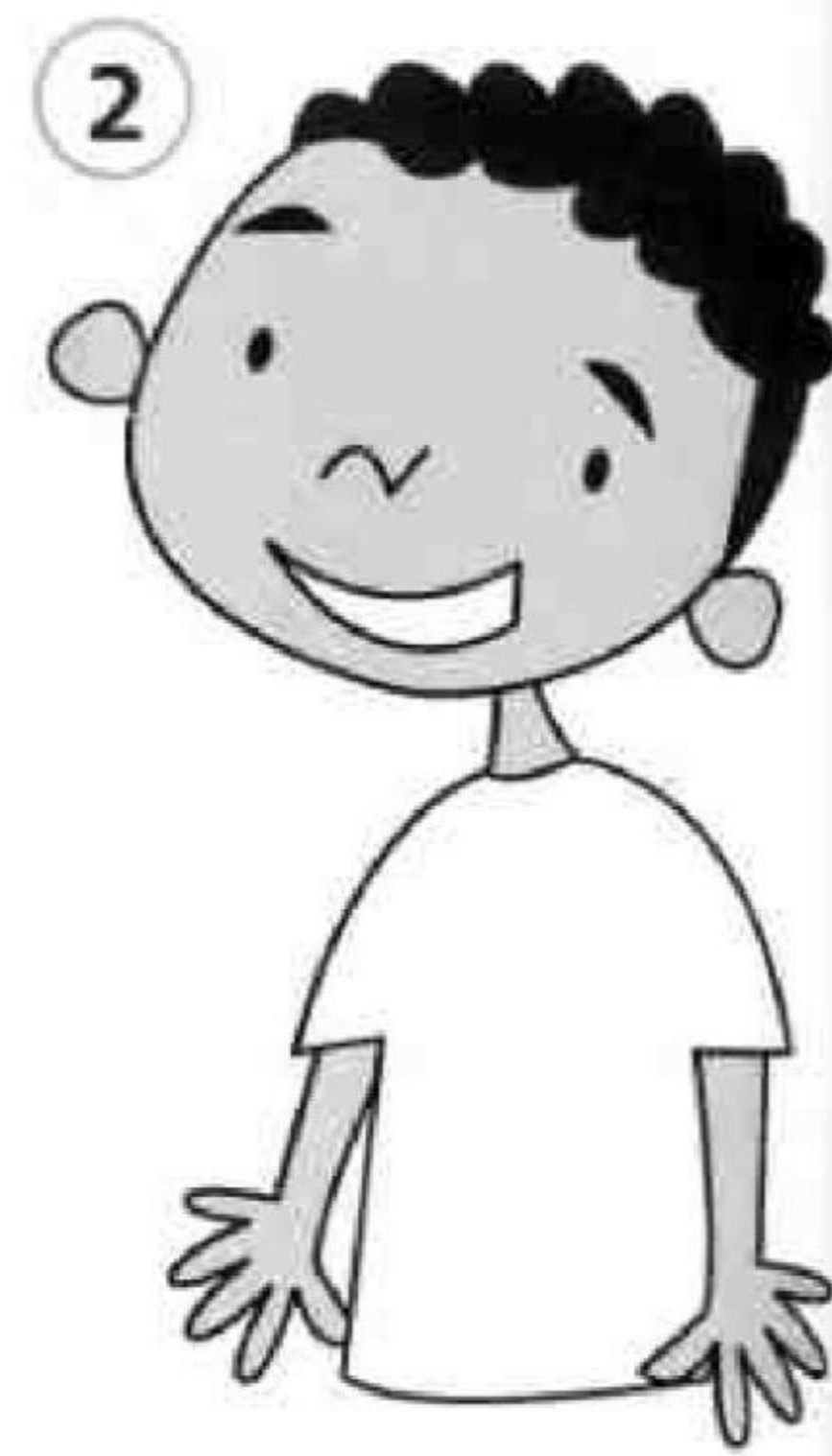
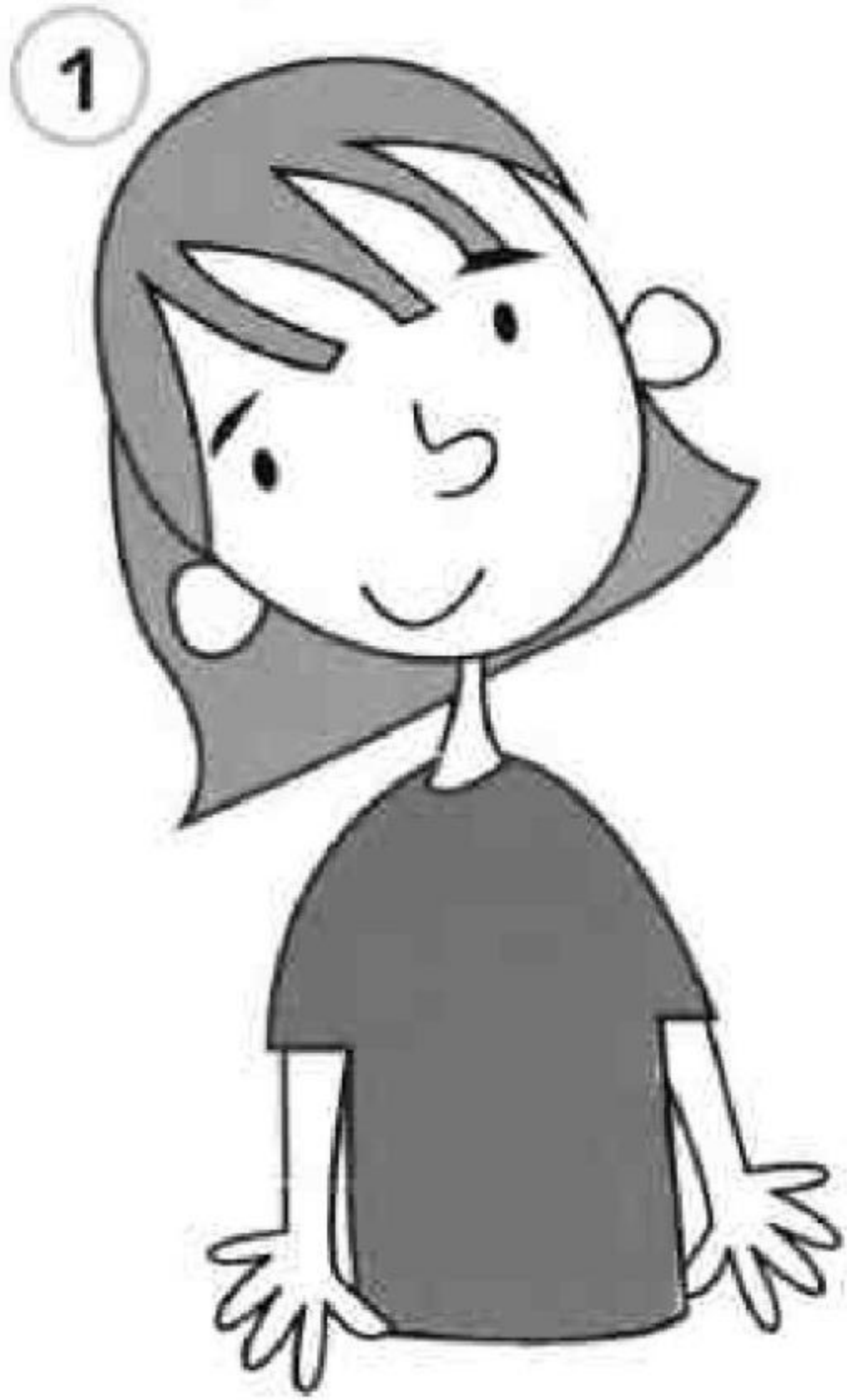

1 Think! Look and circle.

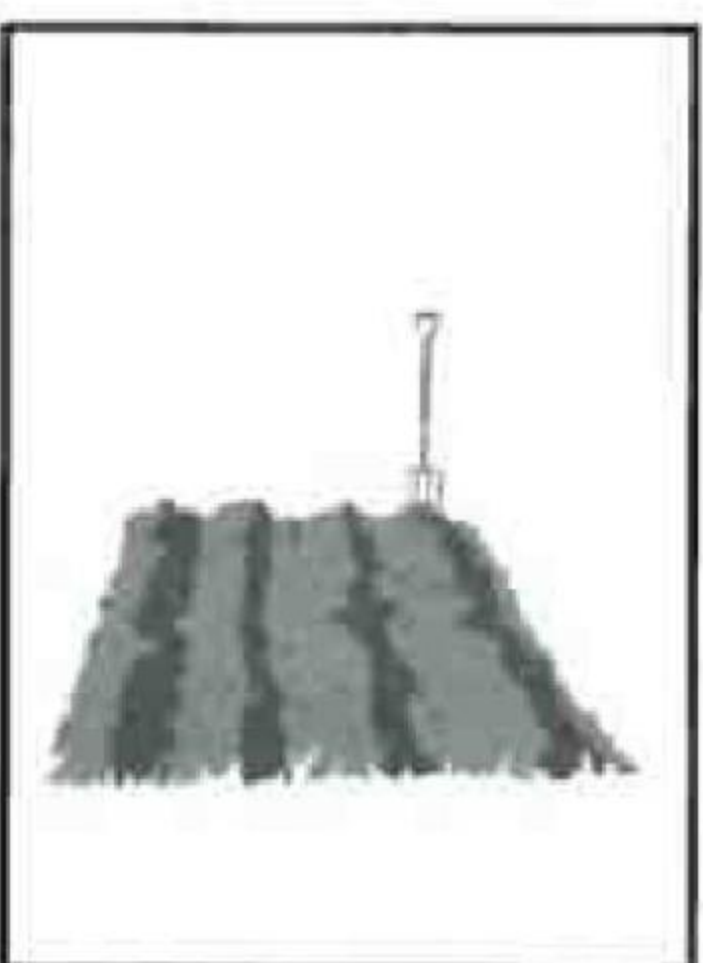
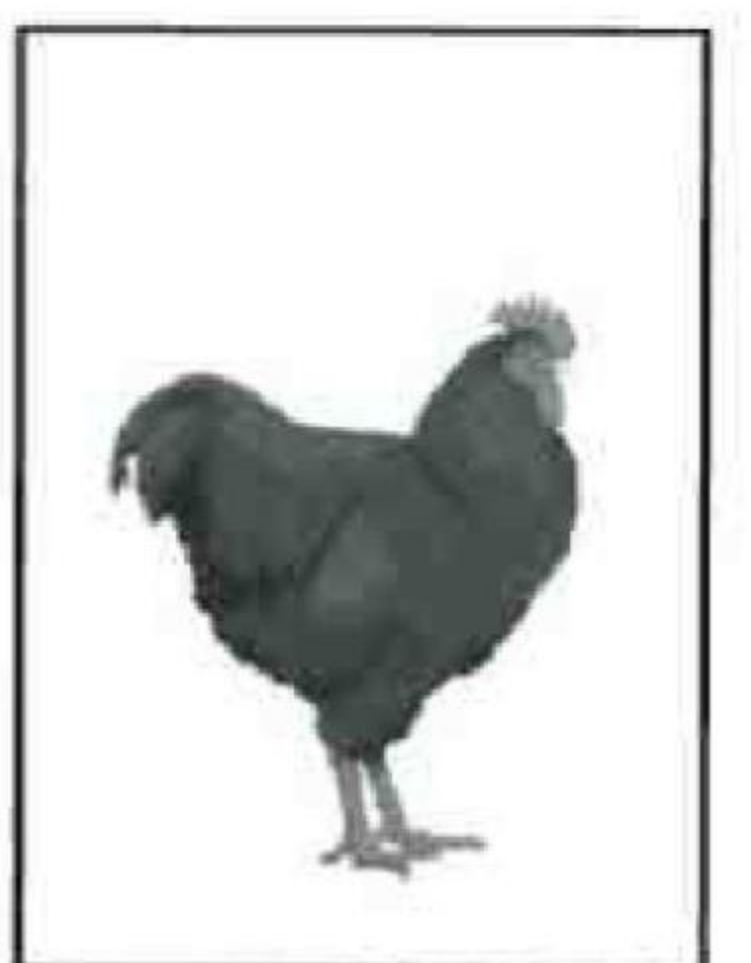
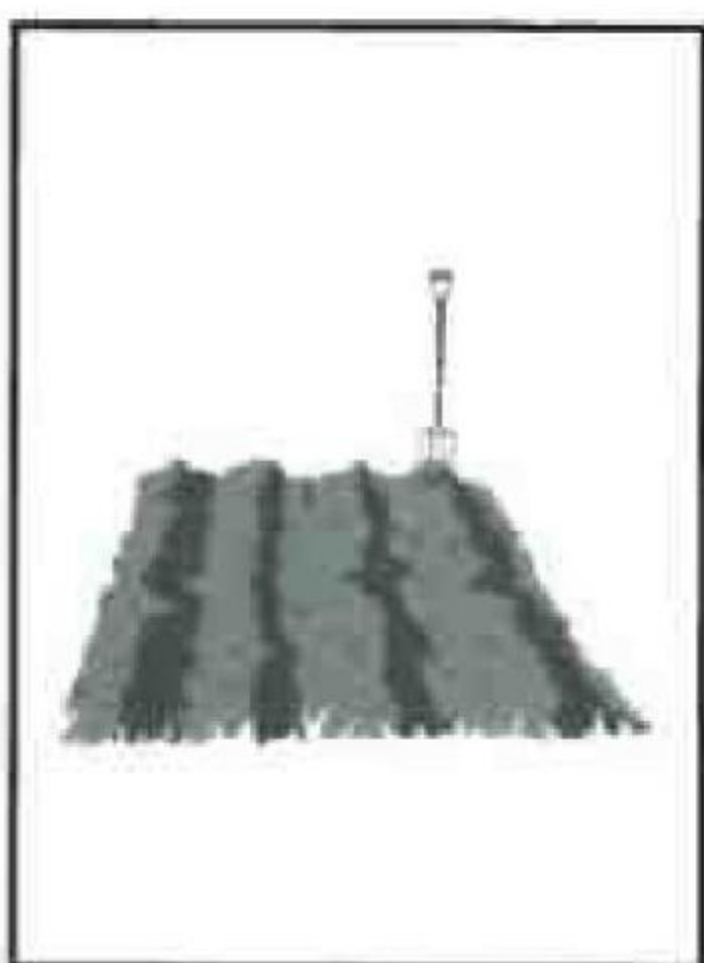
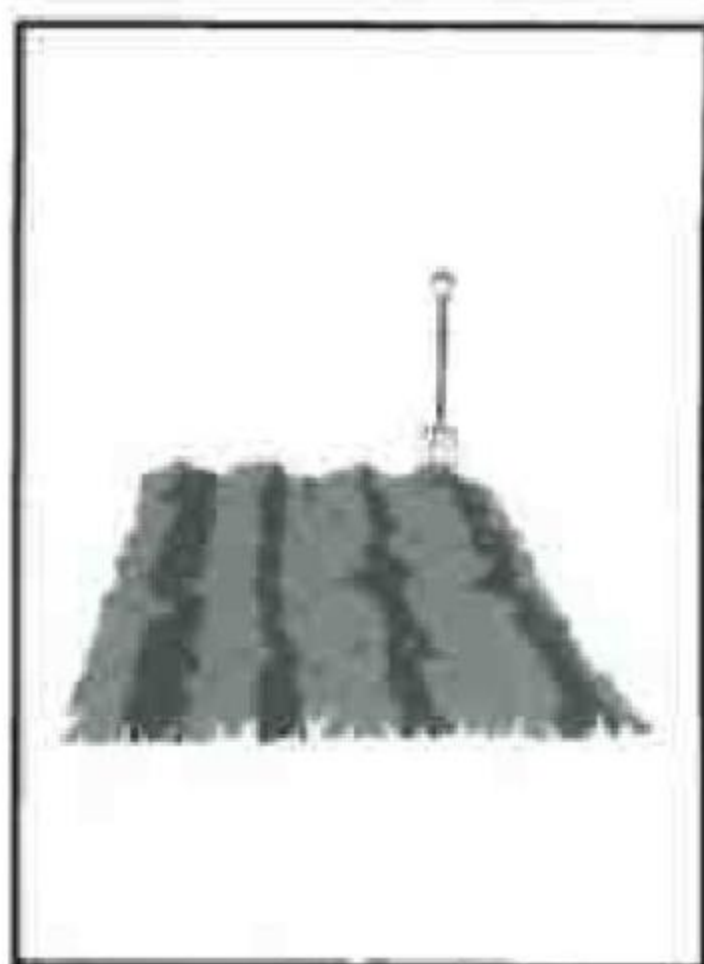
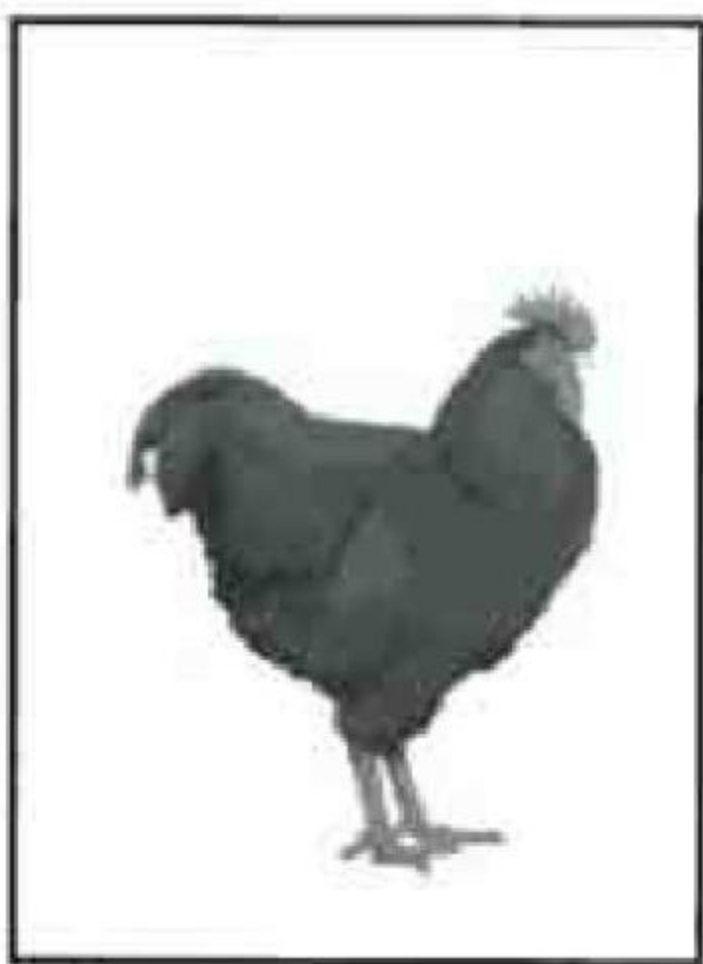
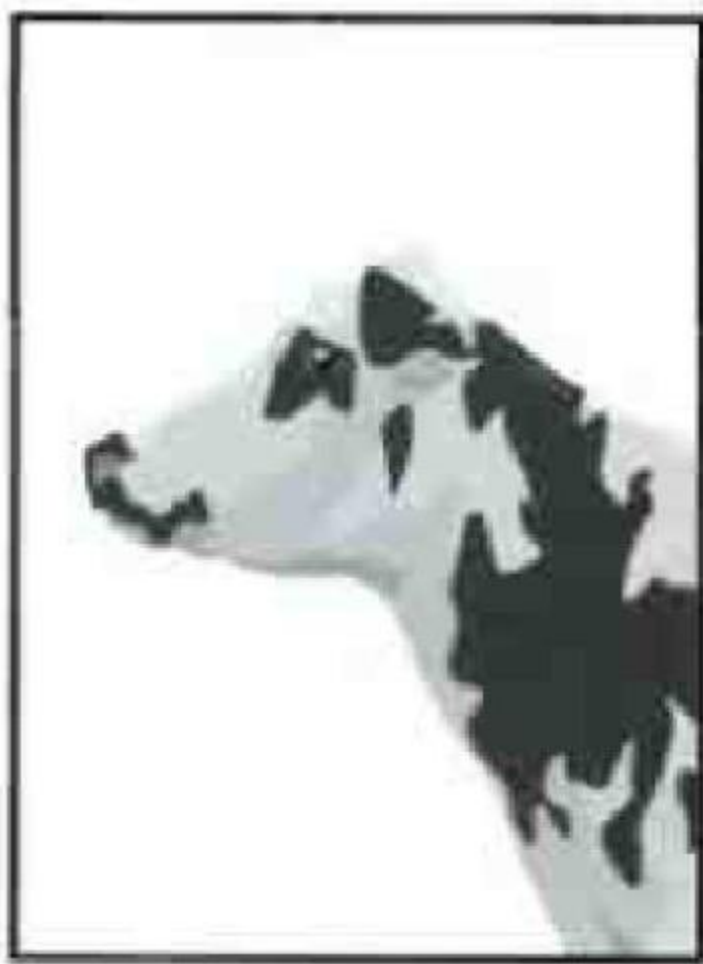
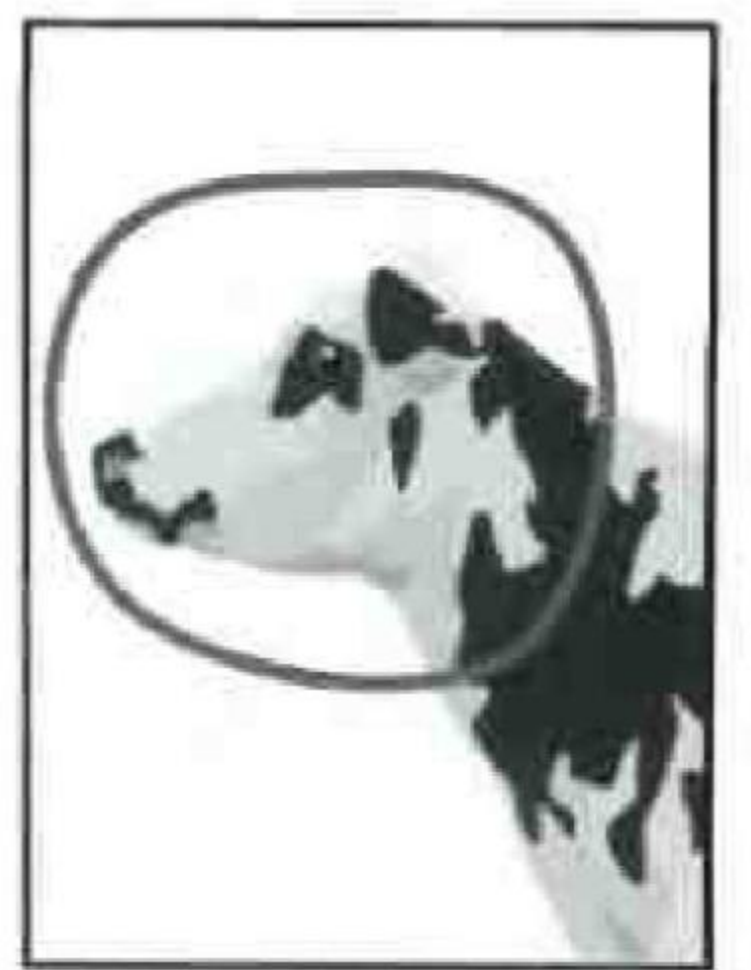

1 Make biscuit faces.

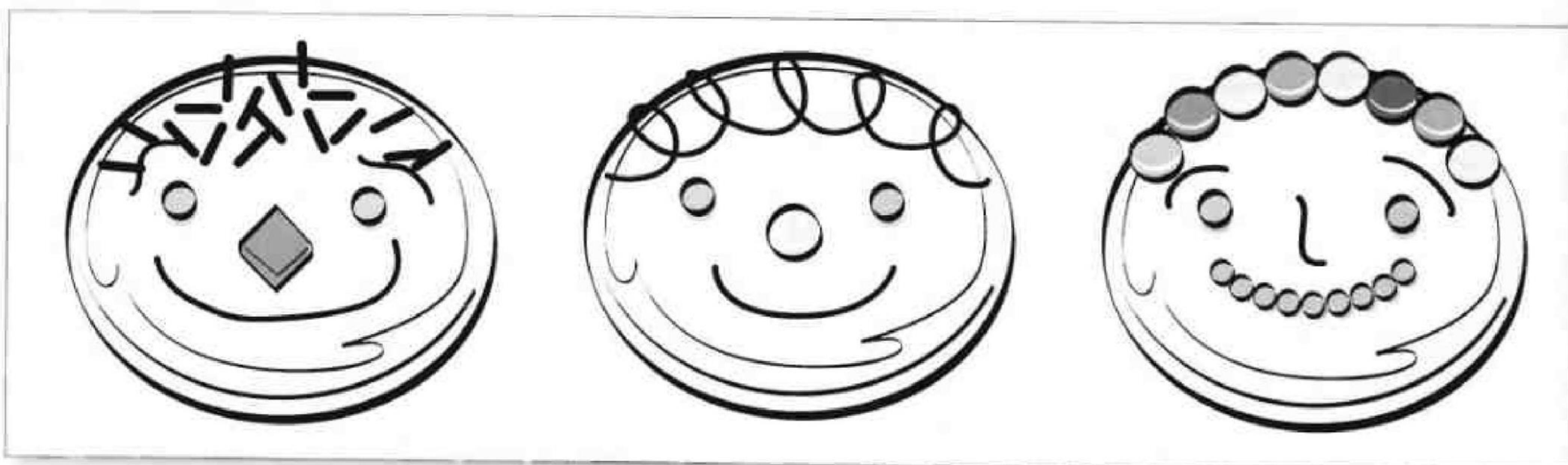
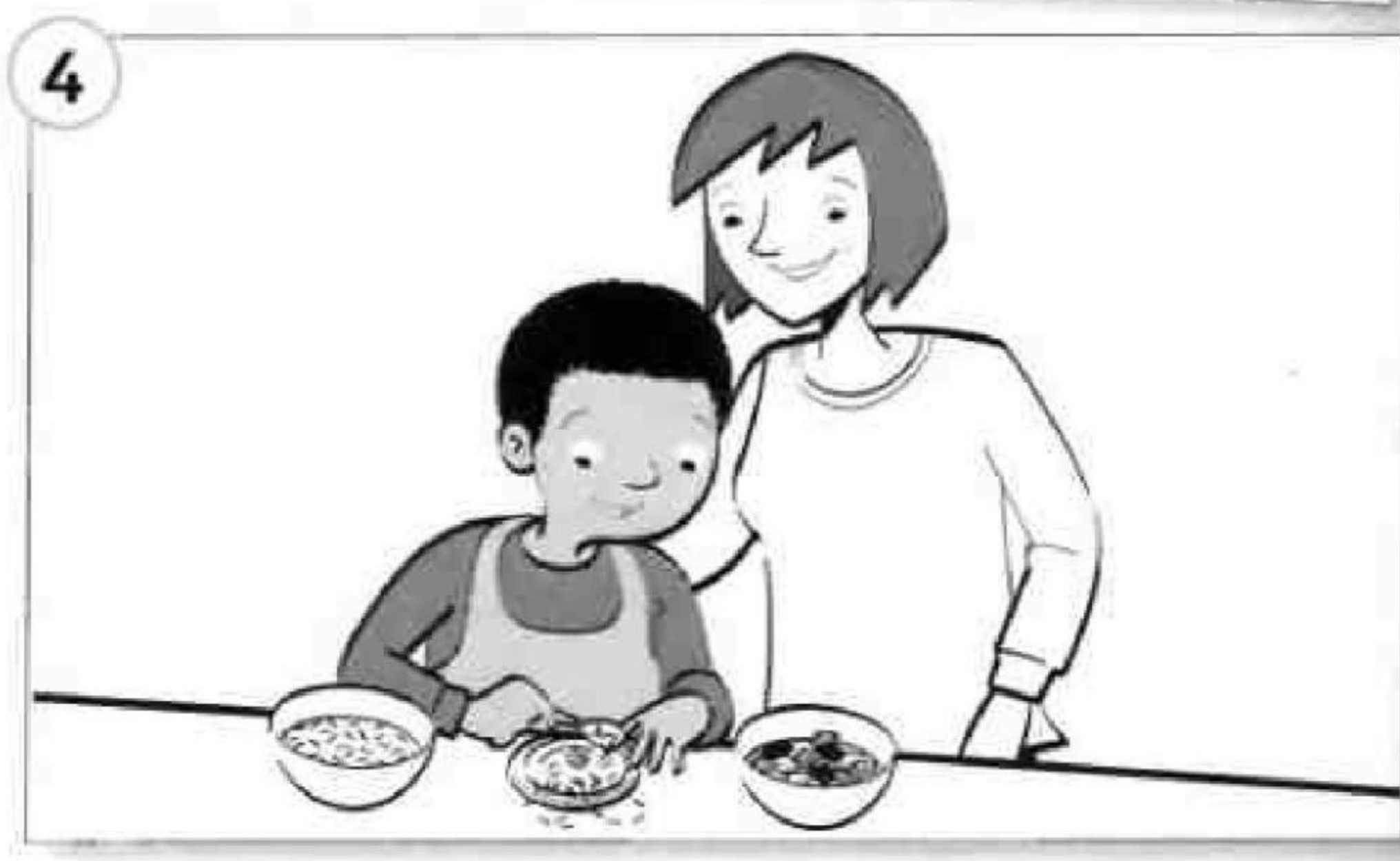
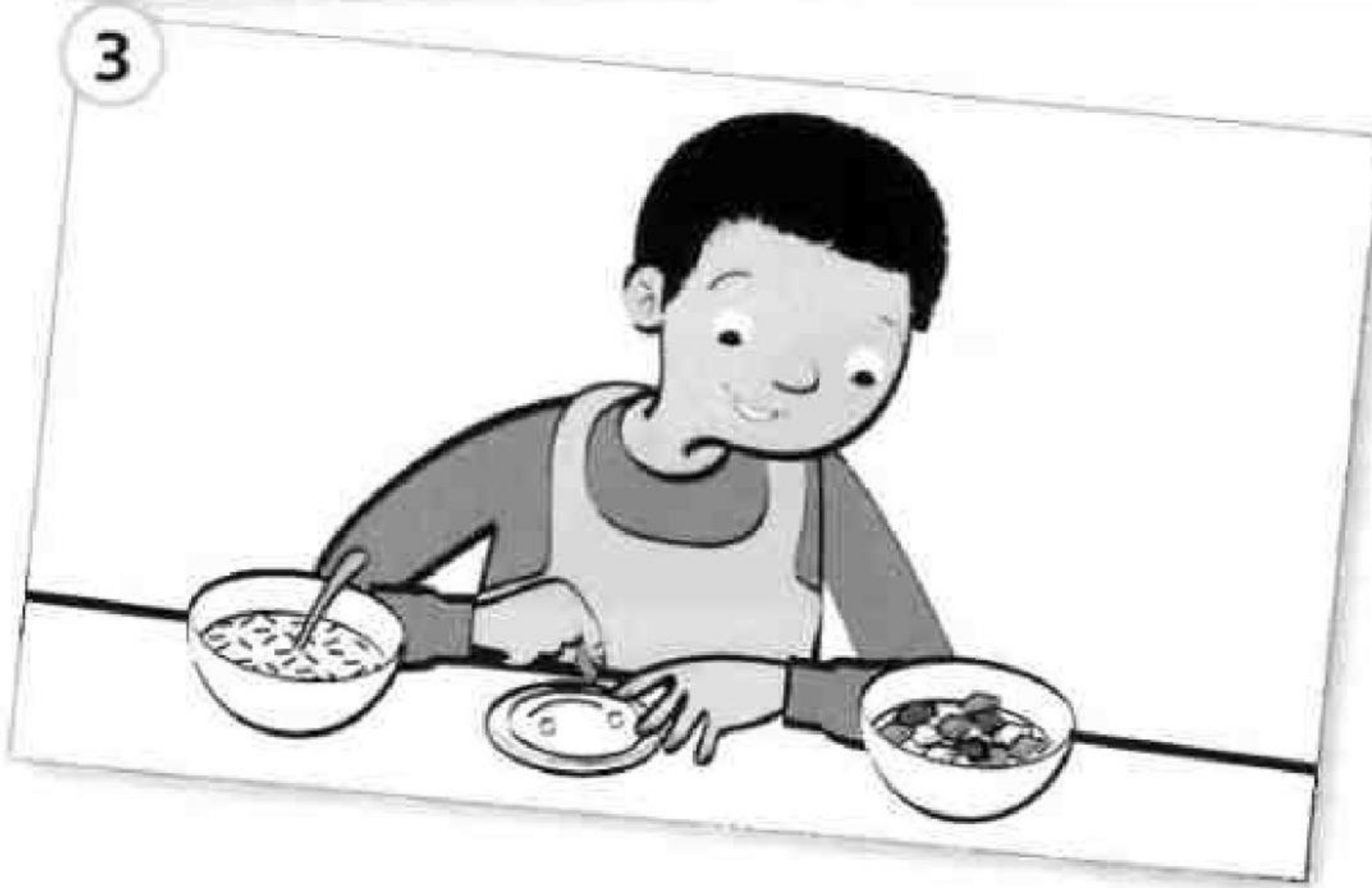
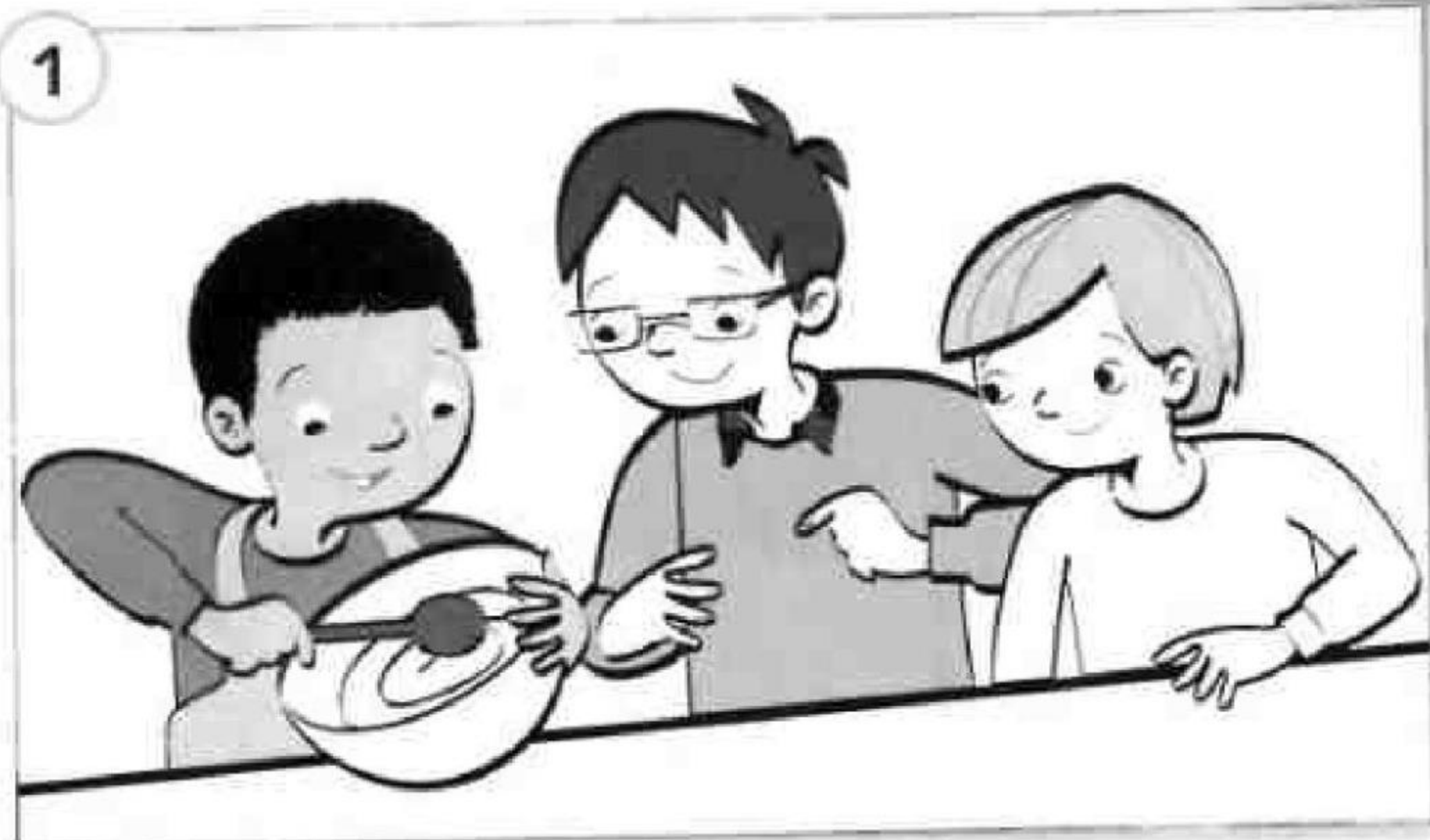
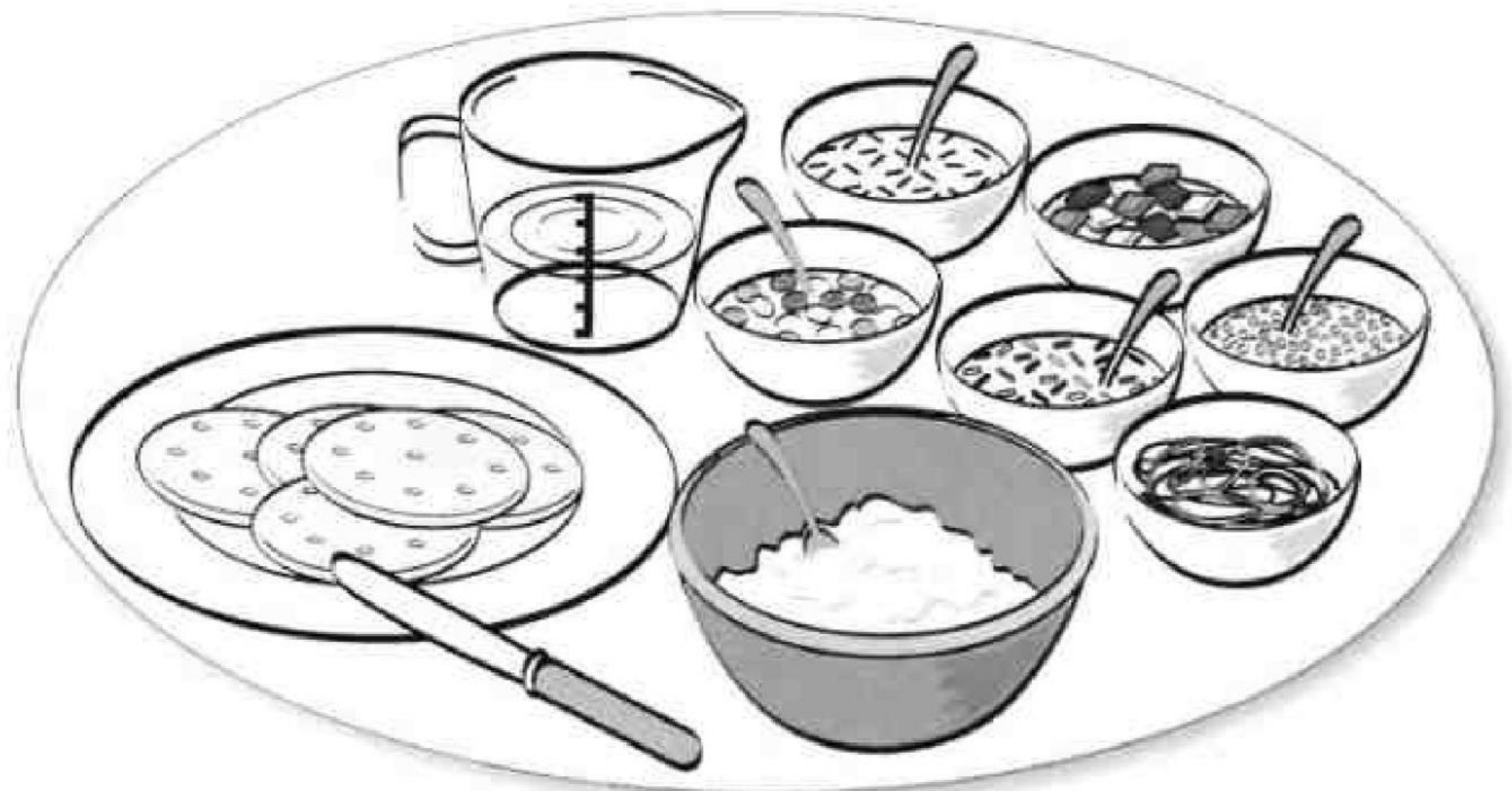

1 Say the words and trace. Colour the circles.

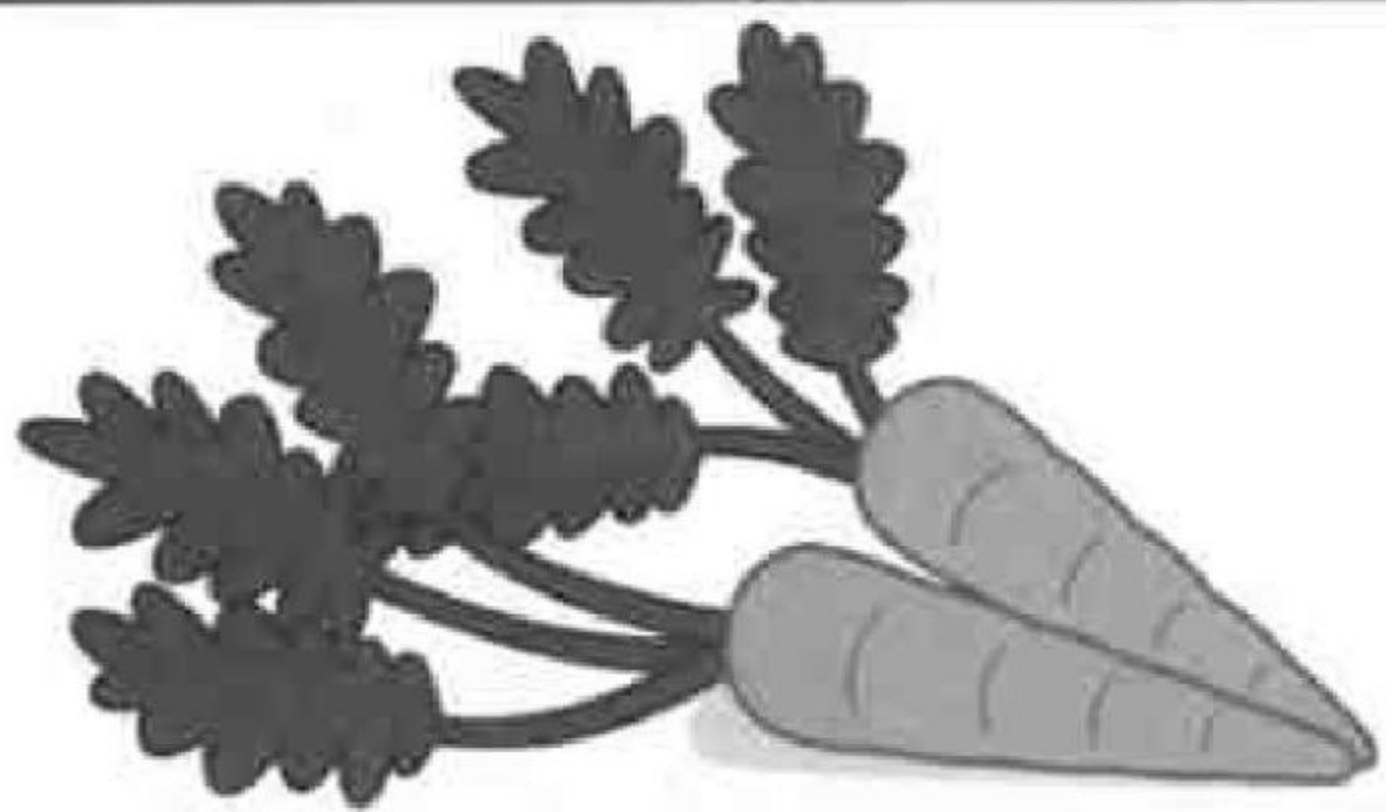

carrots



sausages

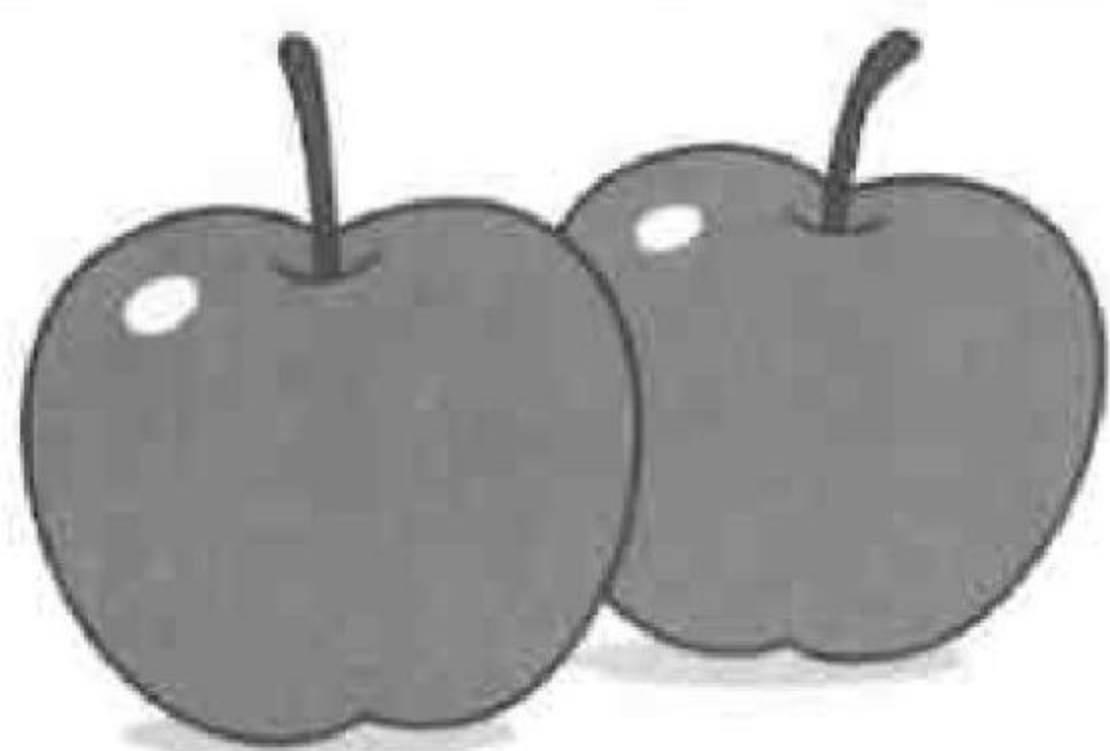

apples

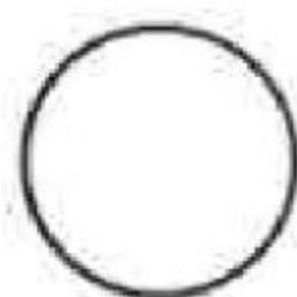

cakes

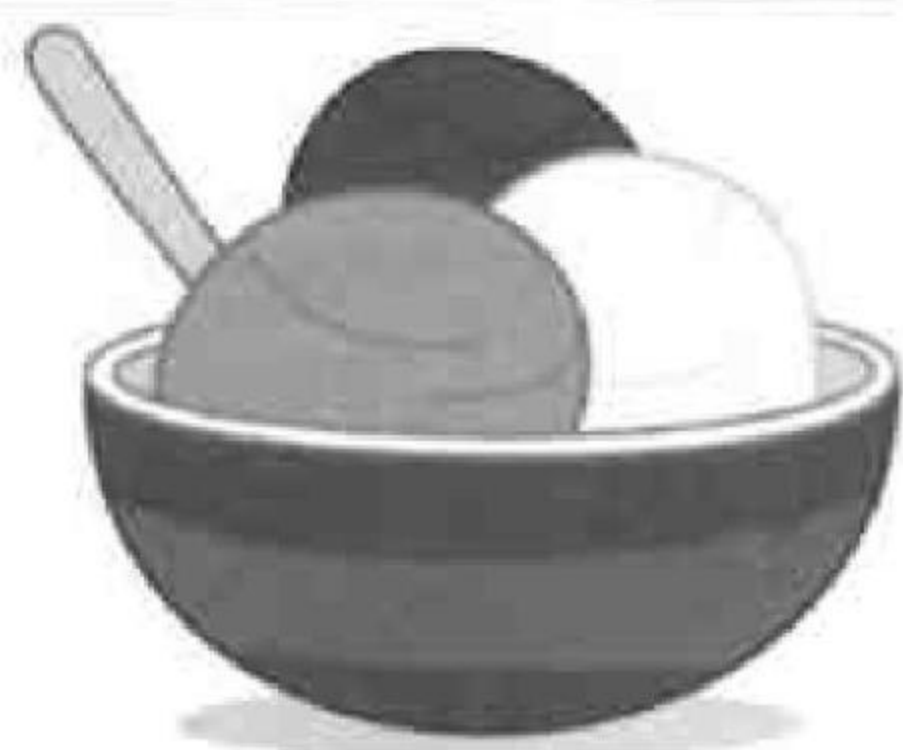
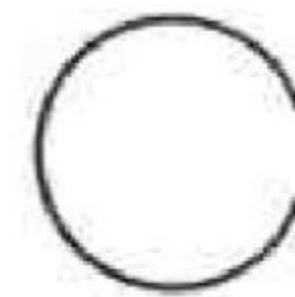

ice cream

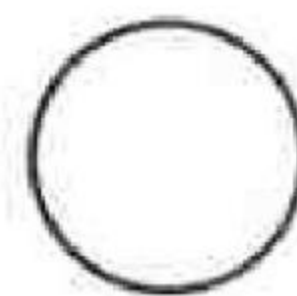

chips

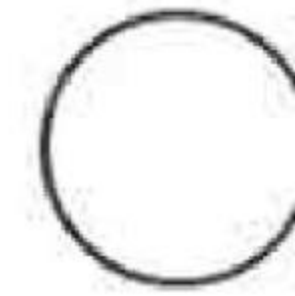

2 Draw faces. 😊 😐 😞

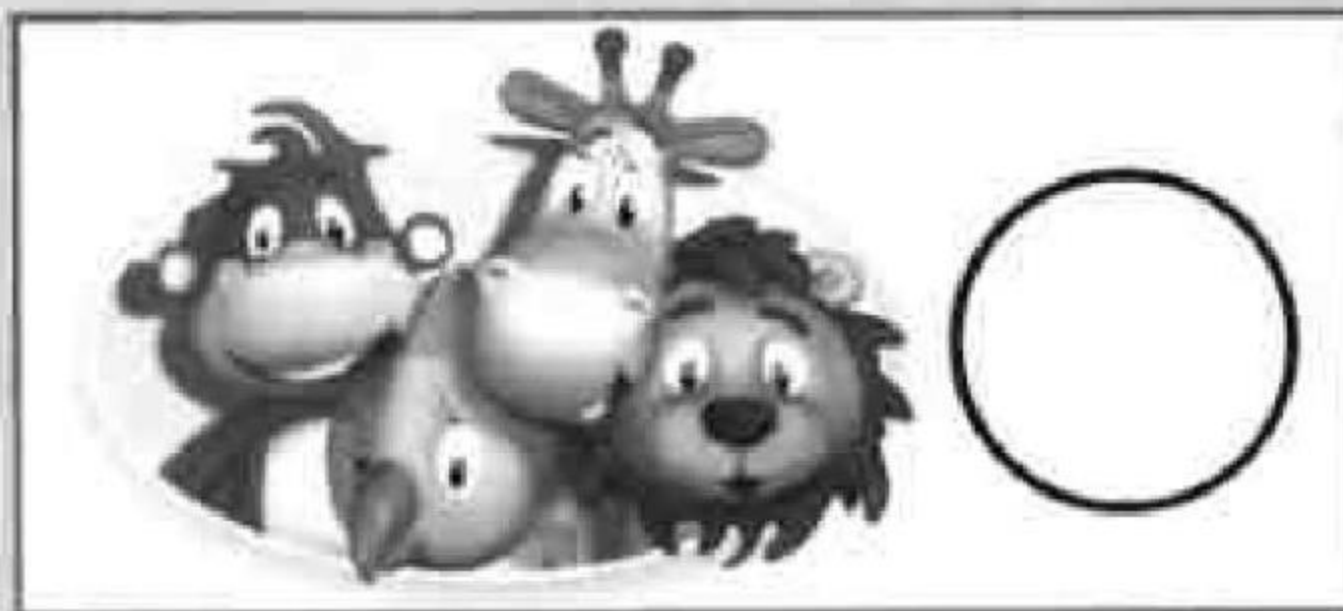

8

All aboard!

1 Think! Match, colour and make sentences.

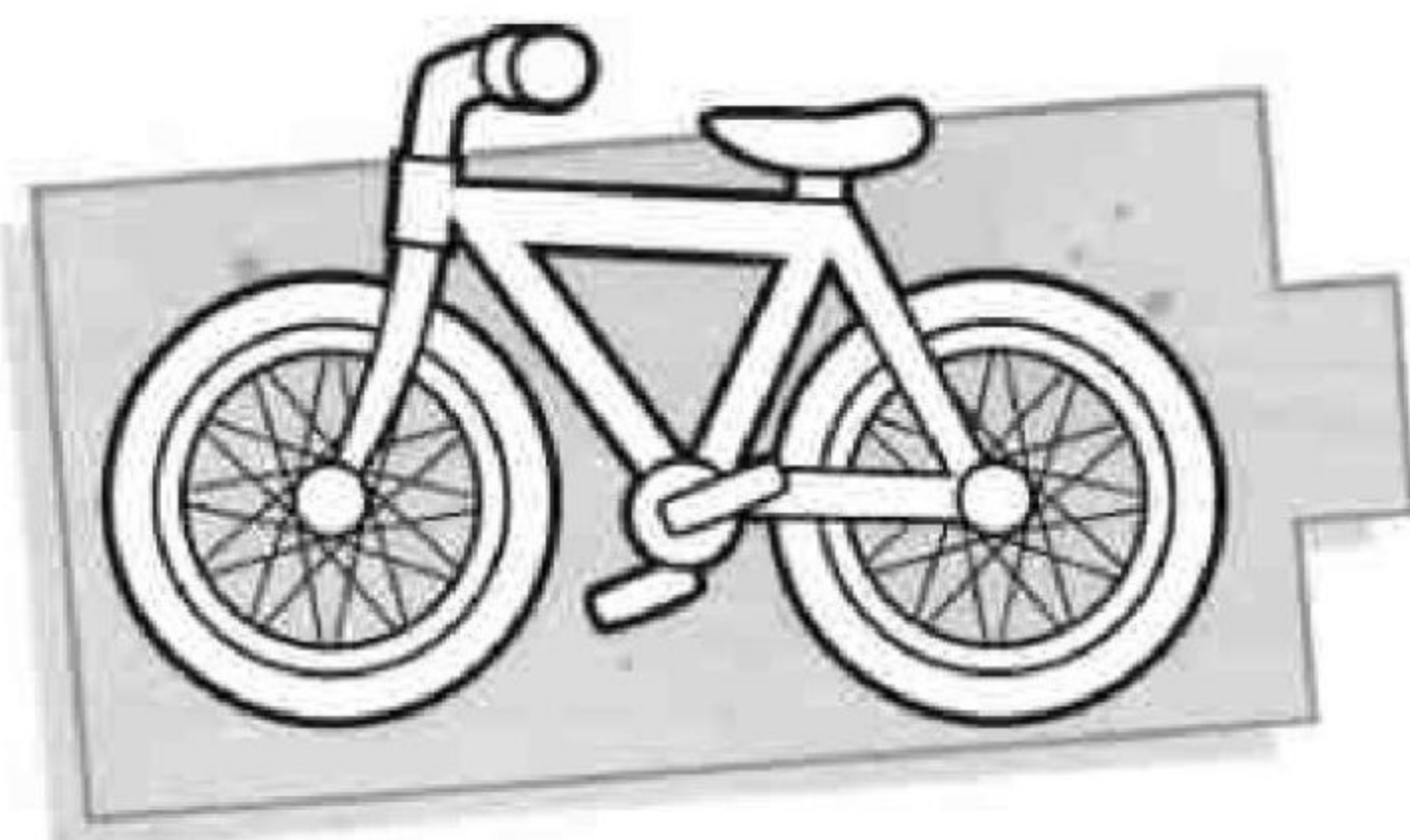
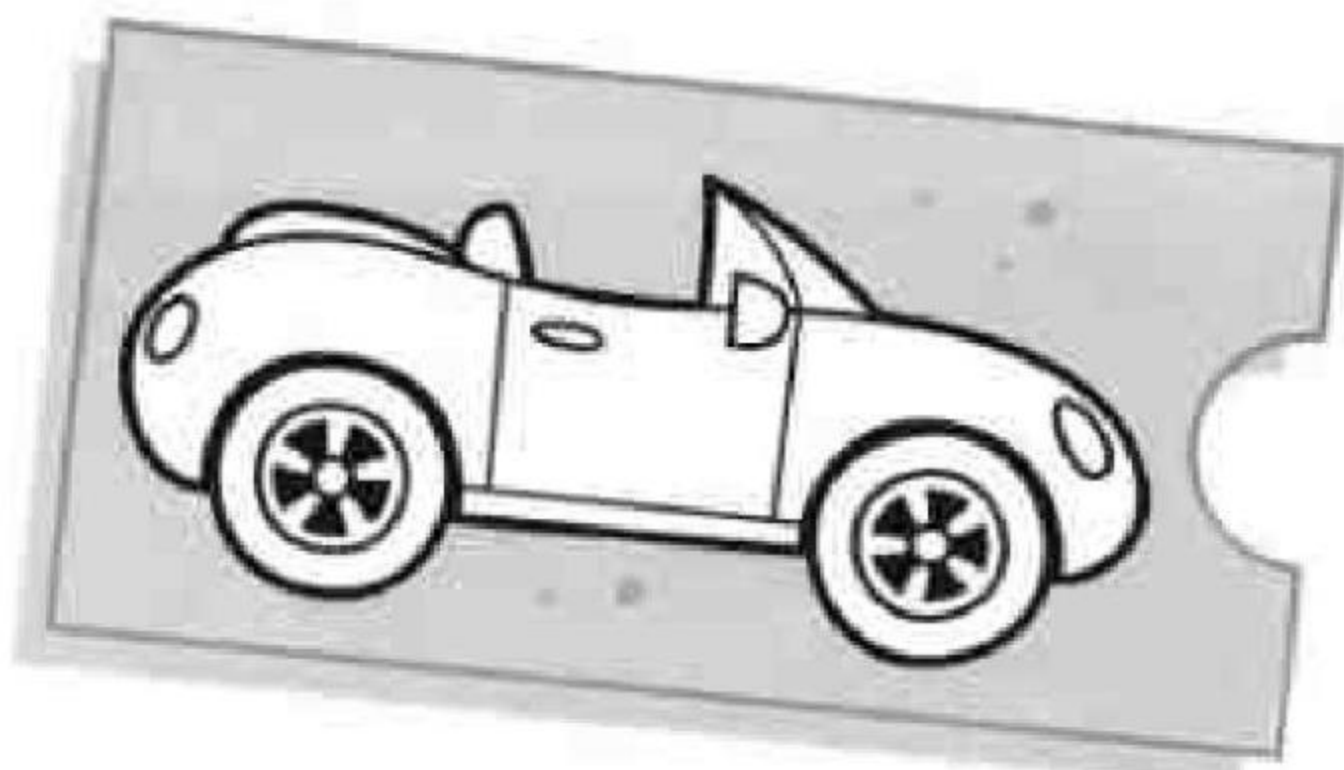
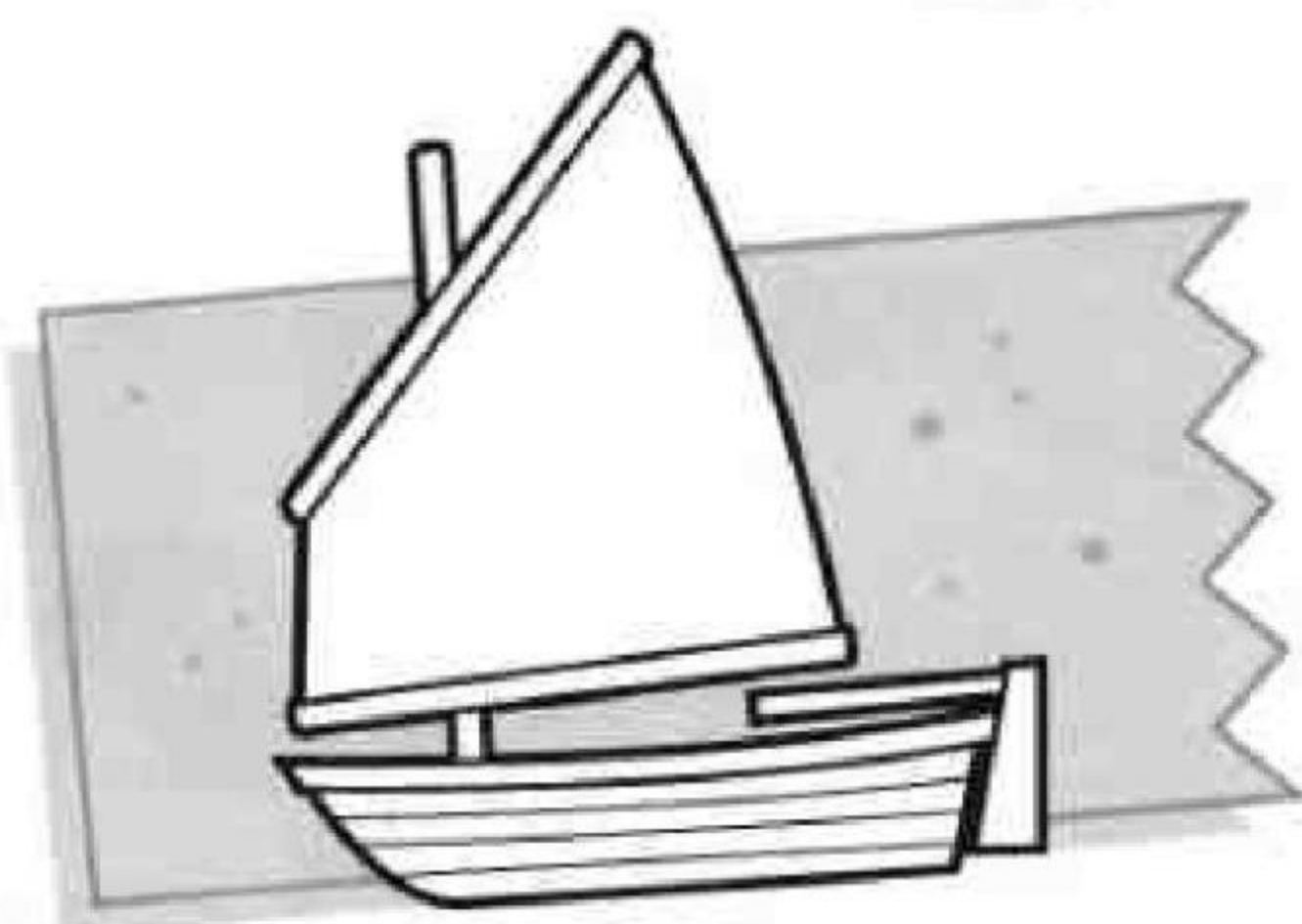
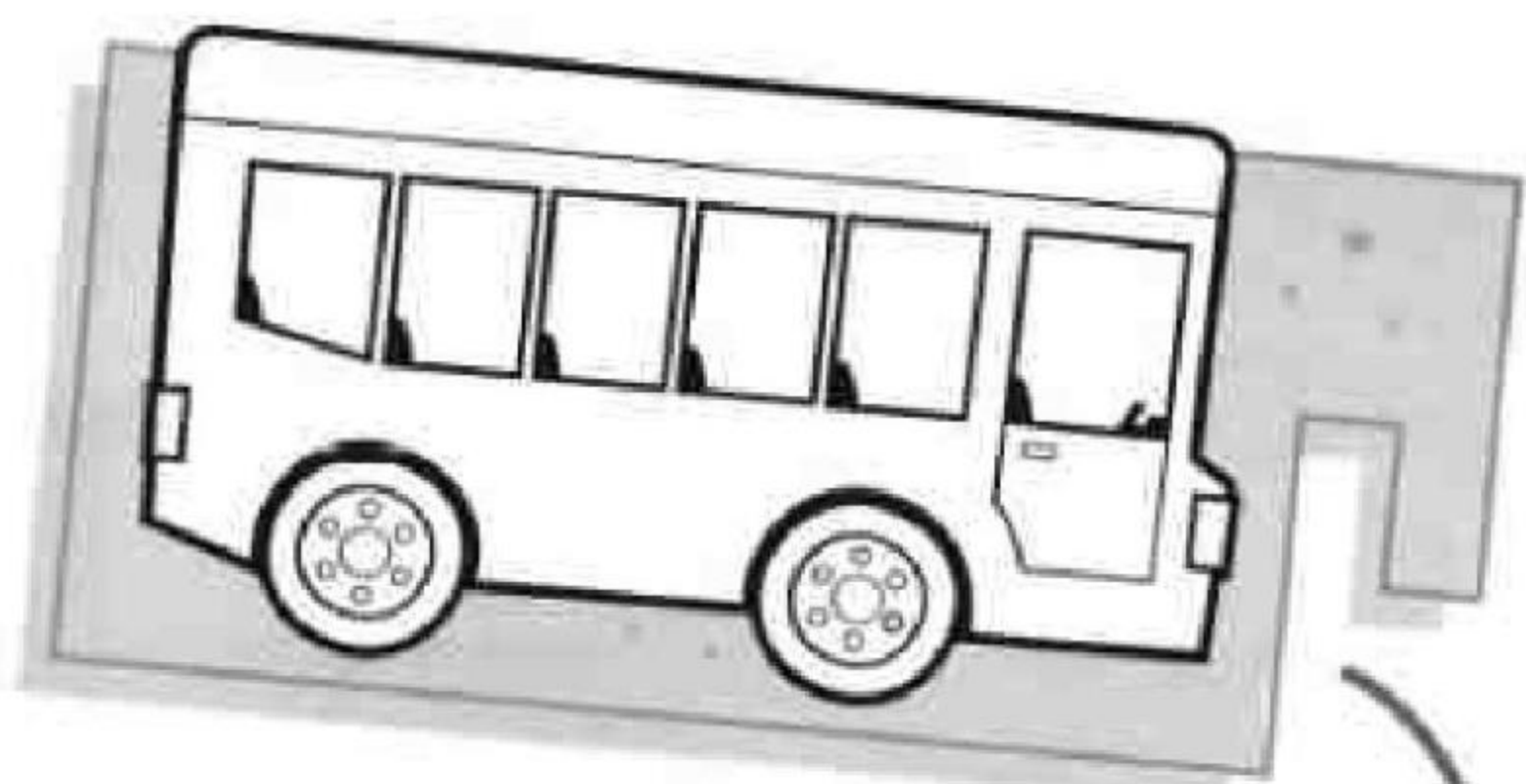

car

bike

scooter

bus

boat

train

1 Follow the lines. Make sentences.

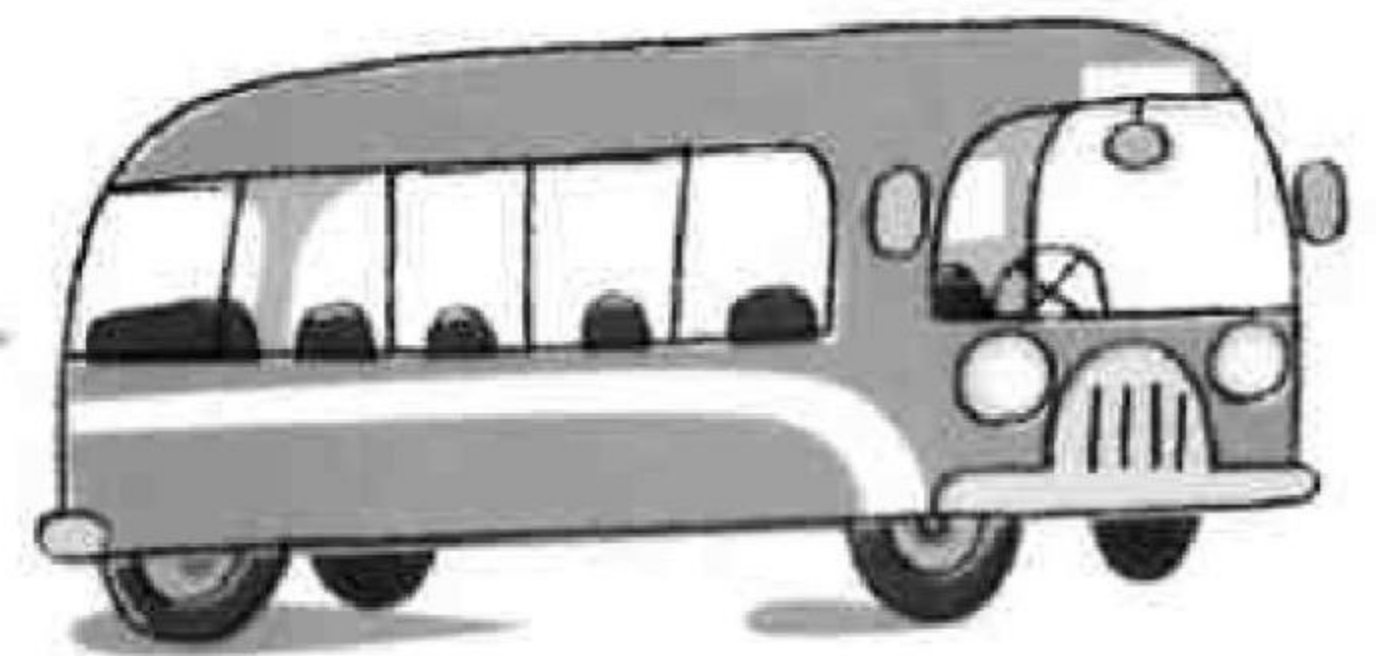
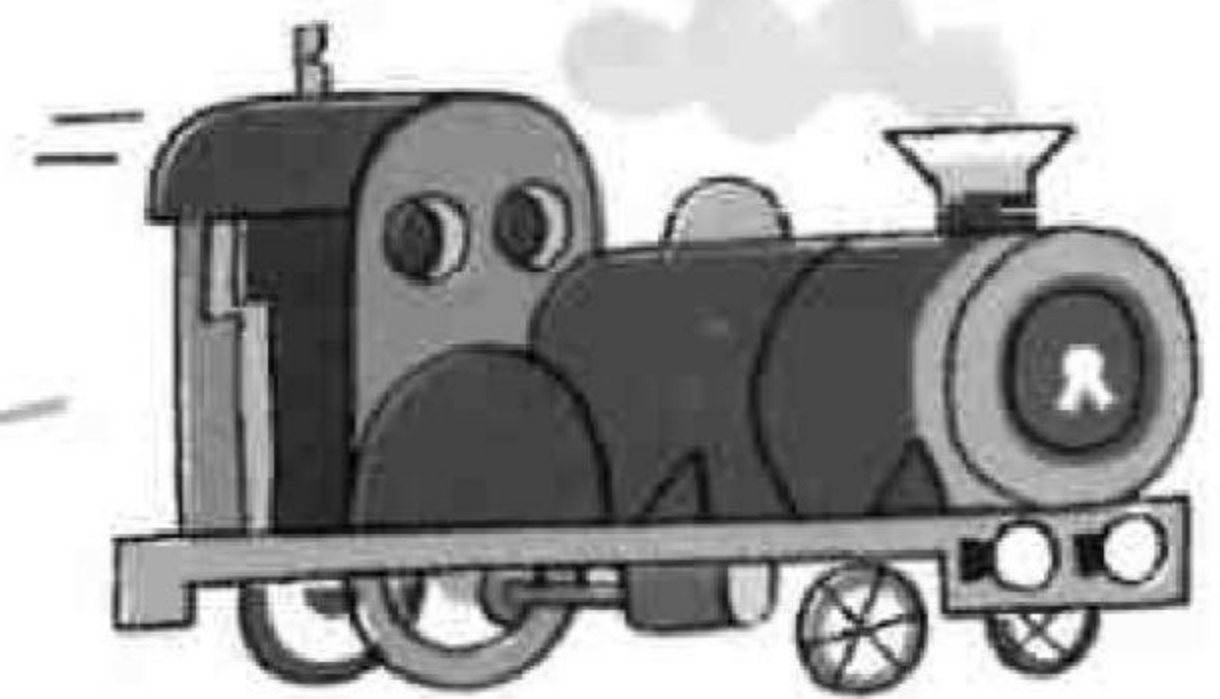
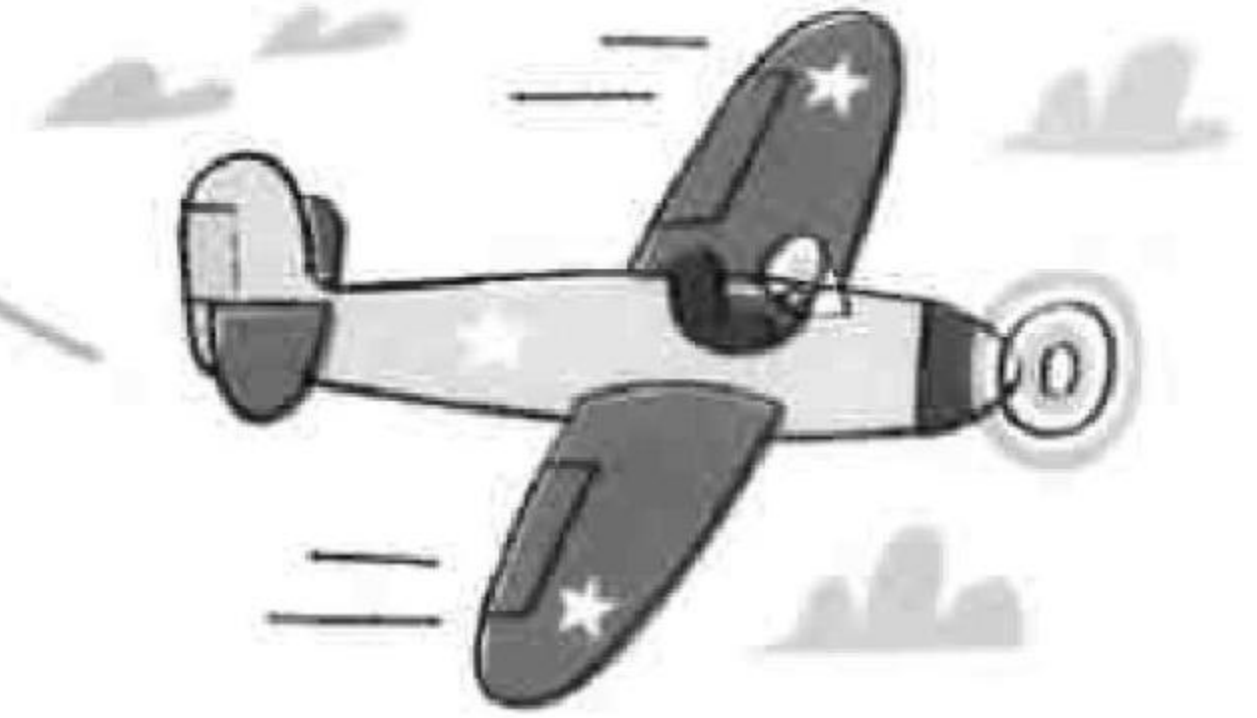

I'm driving / flying / riding / sailing

Listen, point and say the words.

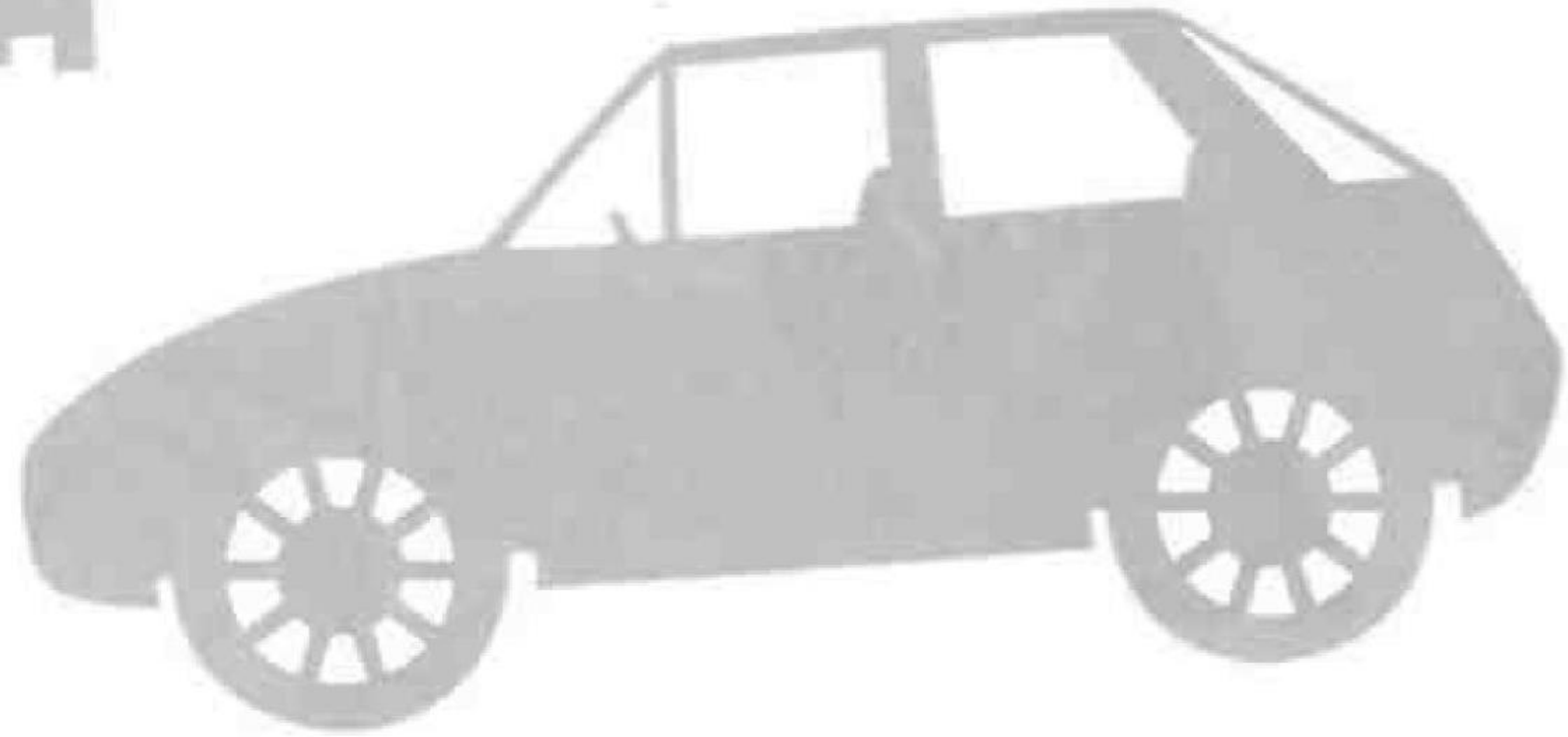
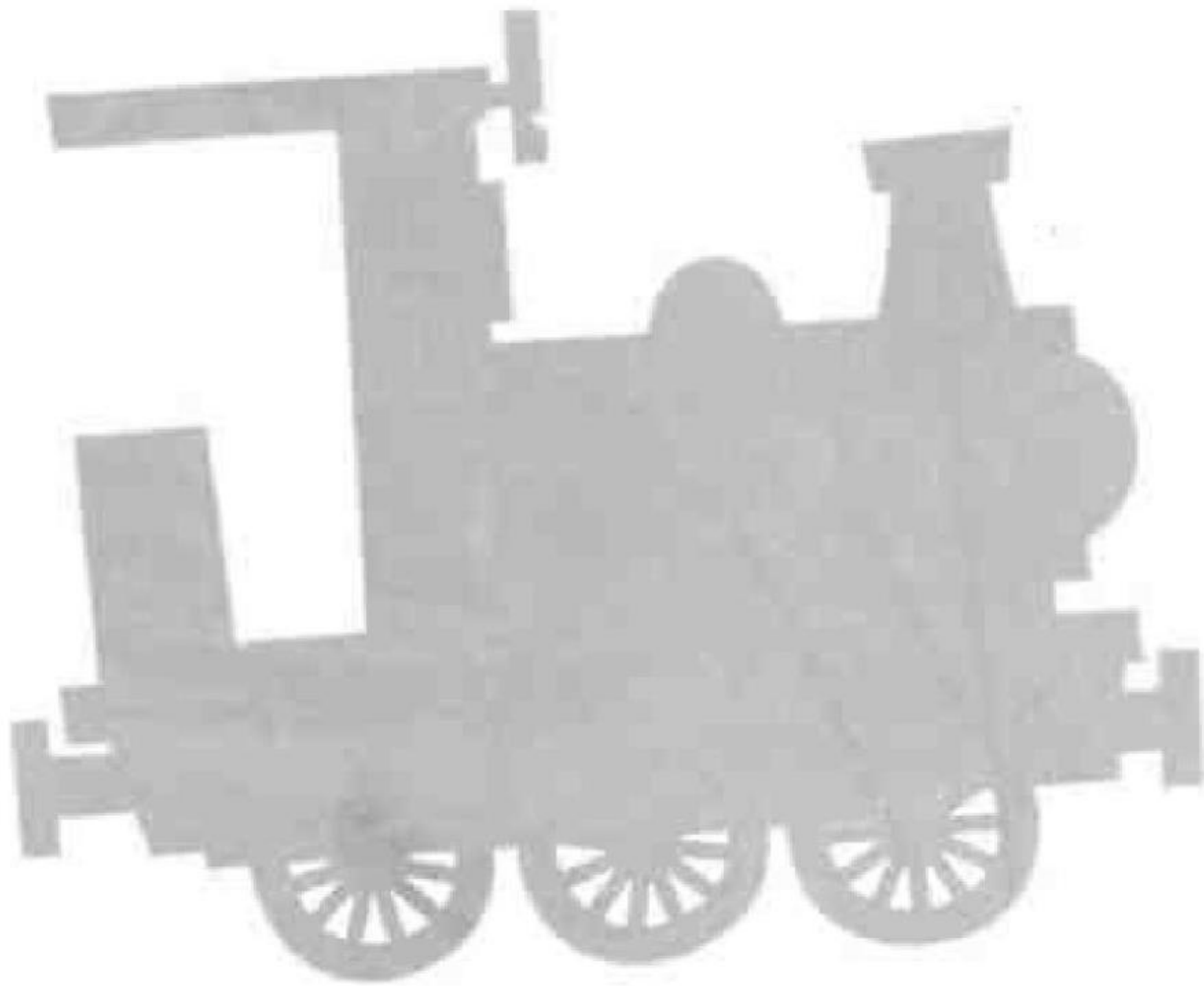

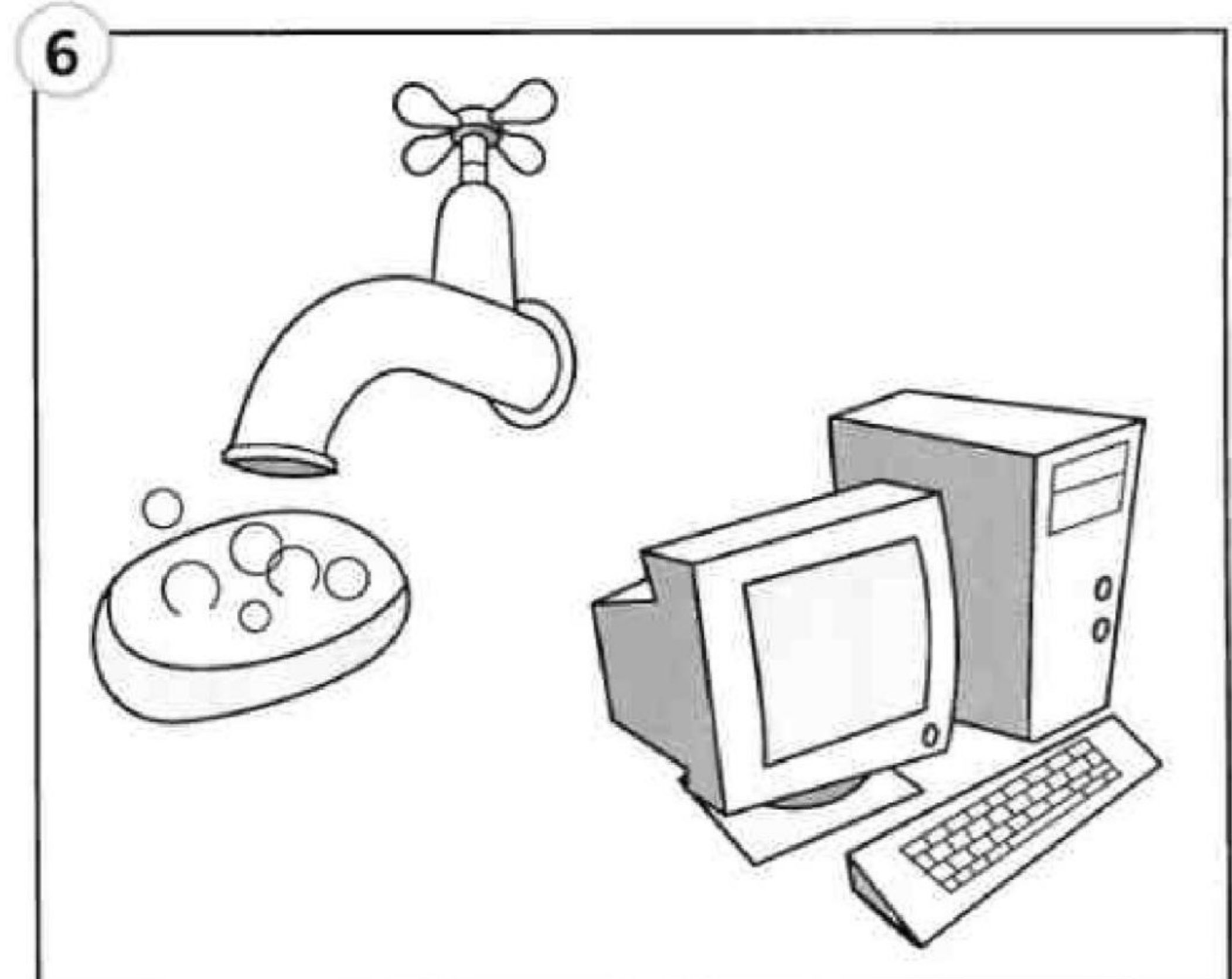
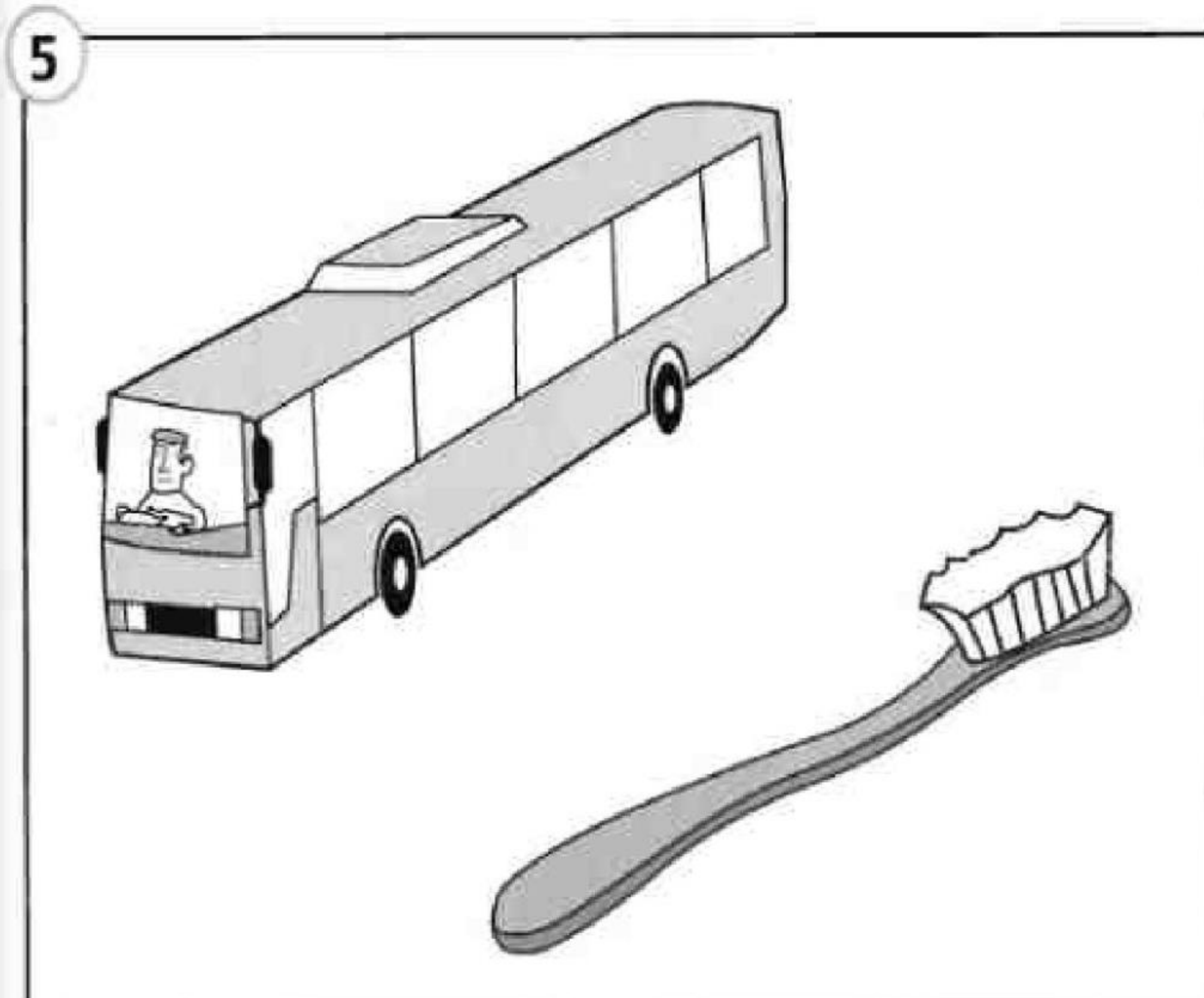
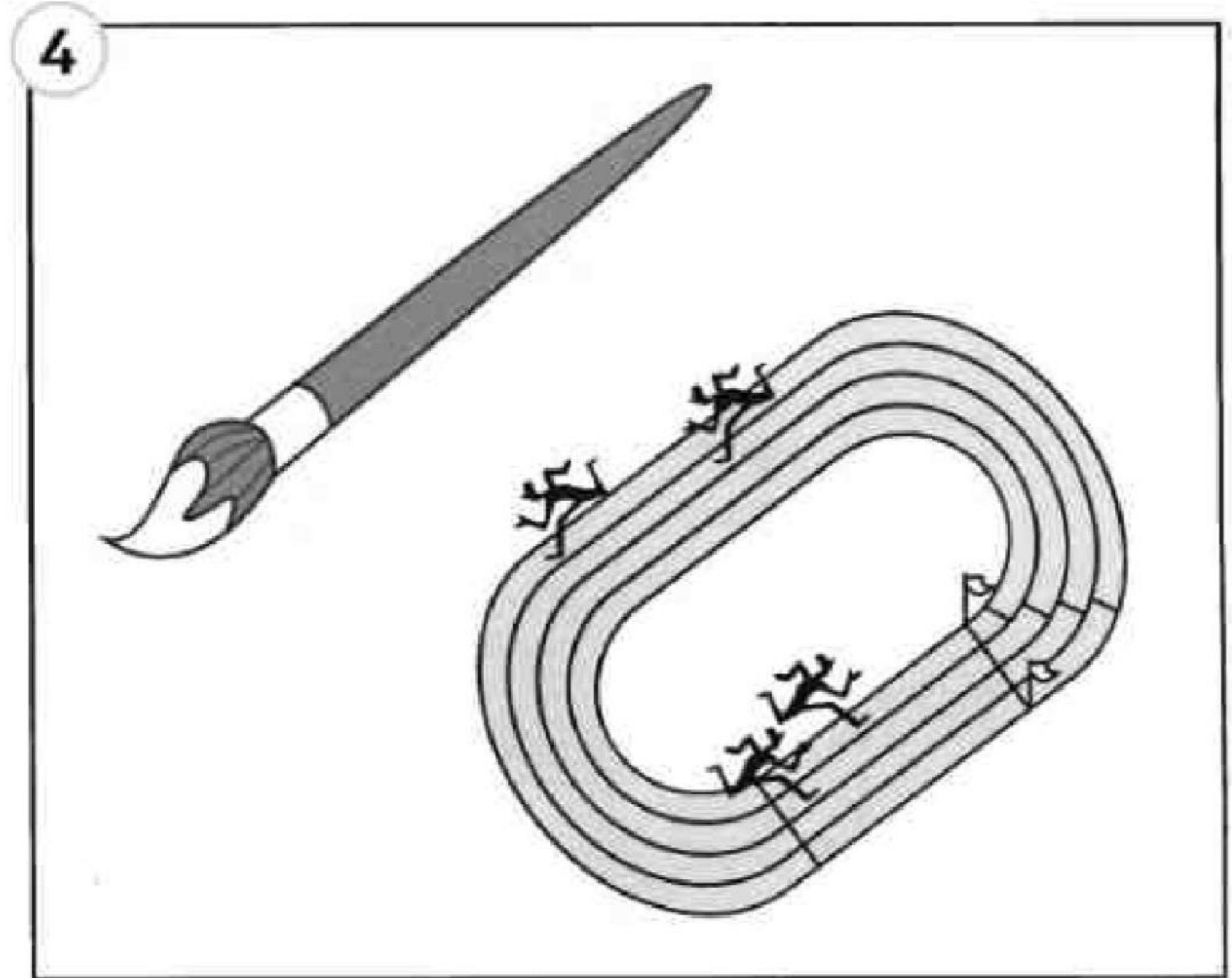
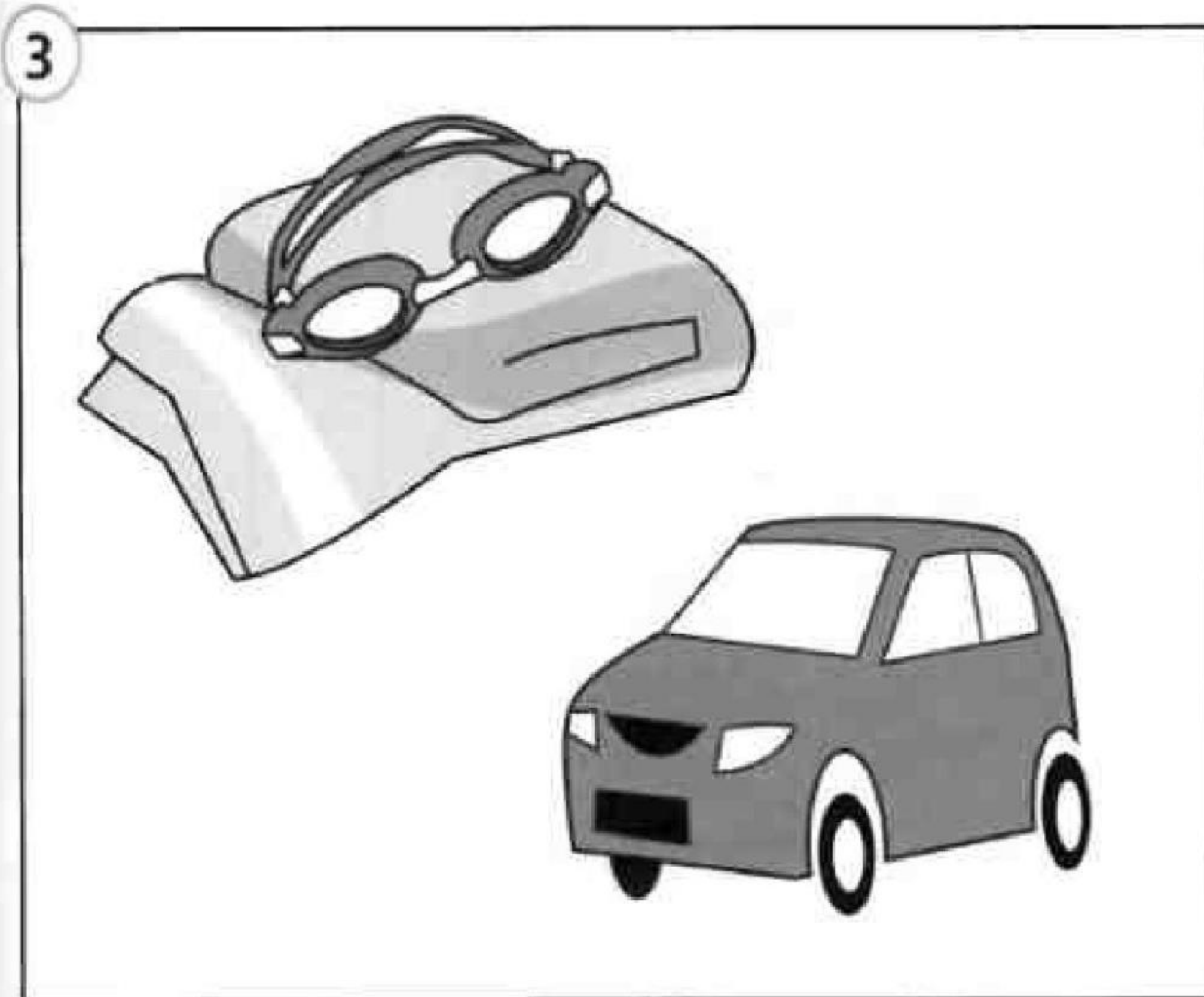
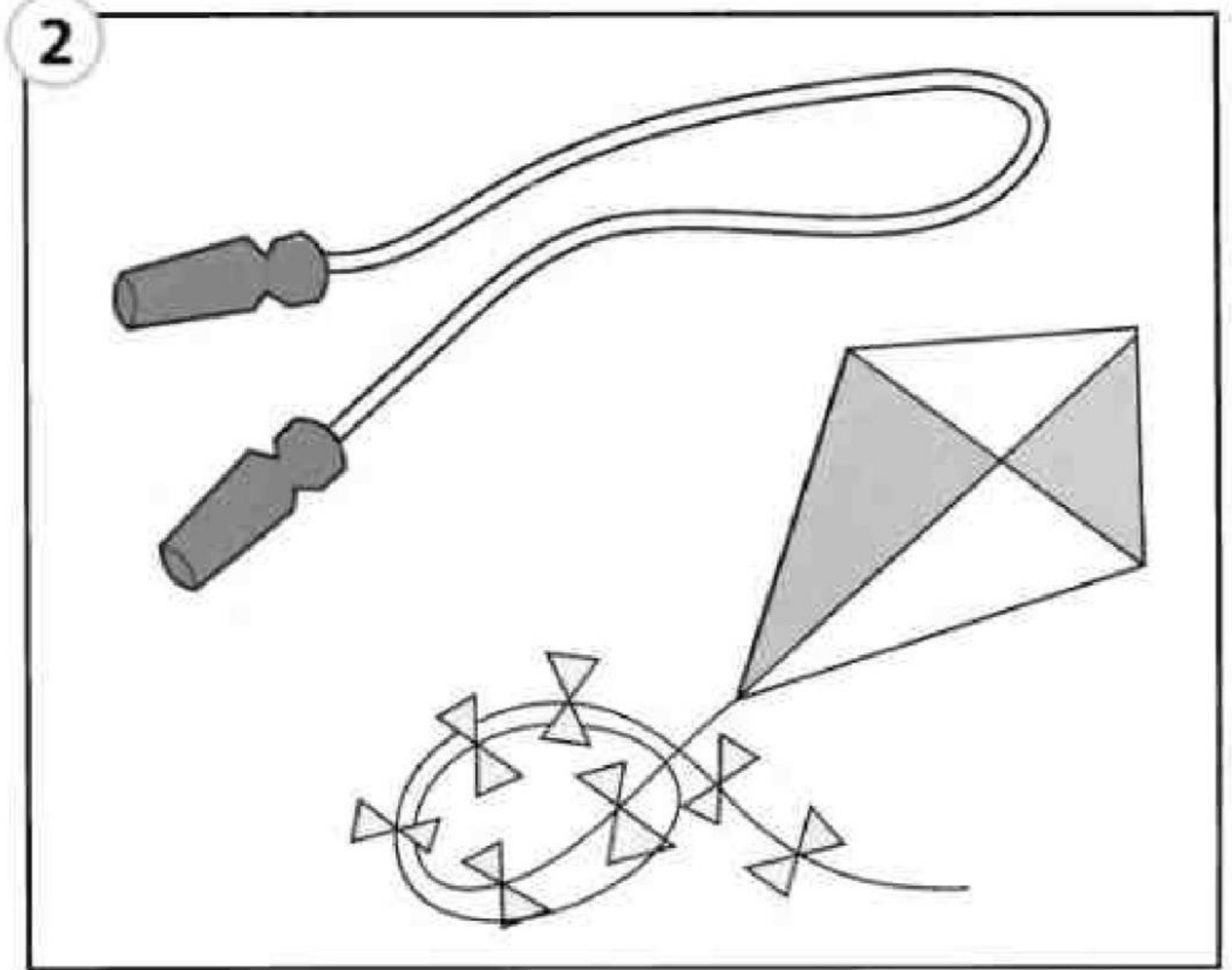
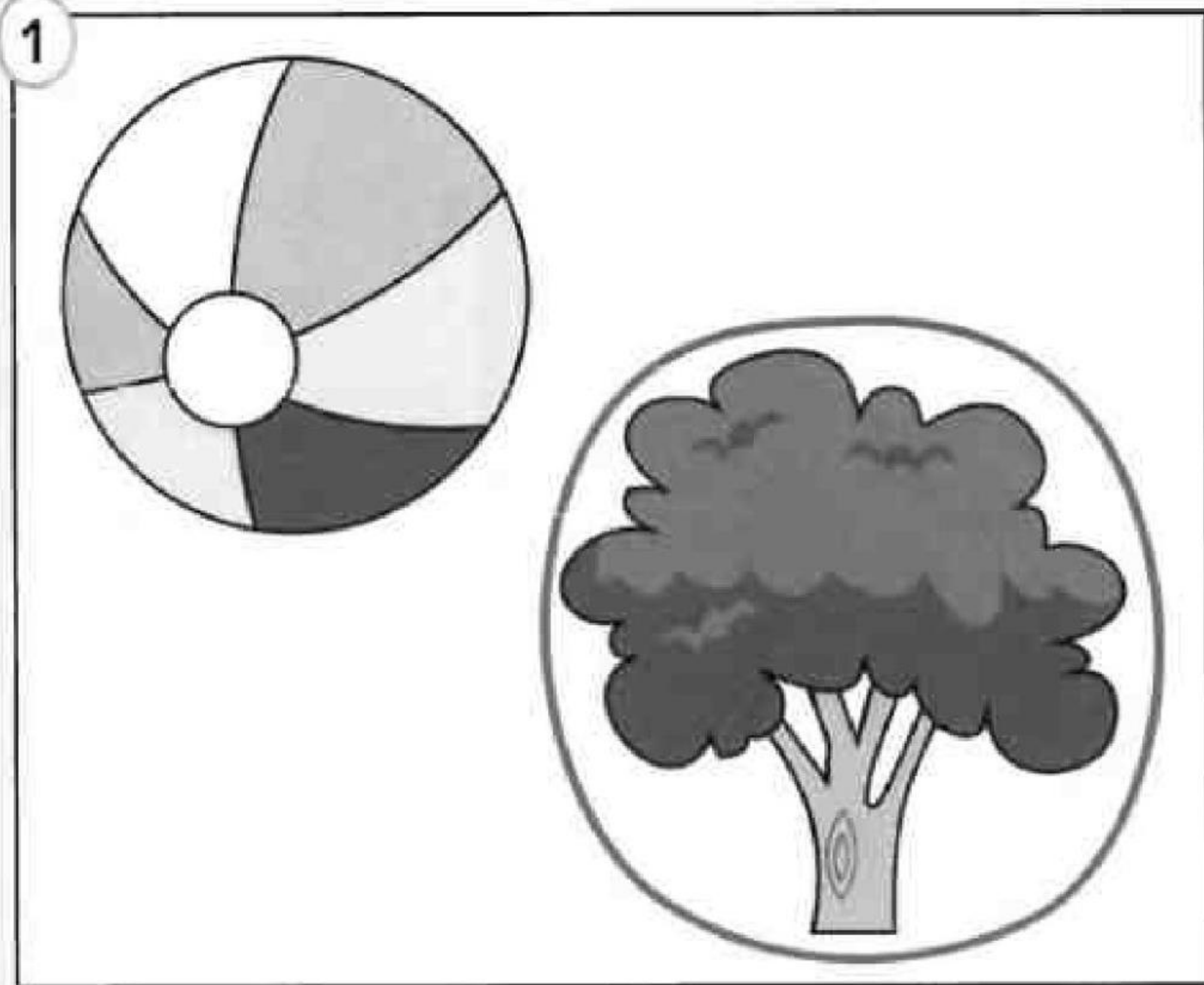
1 CD2
42**Think!** Listen and circle.

flying a kite, swimming, climbing a tree, running,
brushing my teeth, washing my hands

Listen and trace.

1

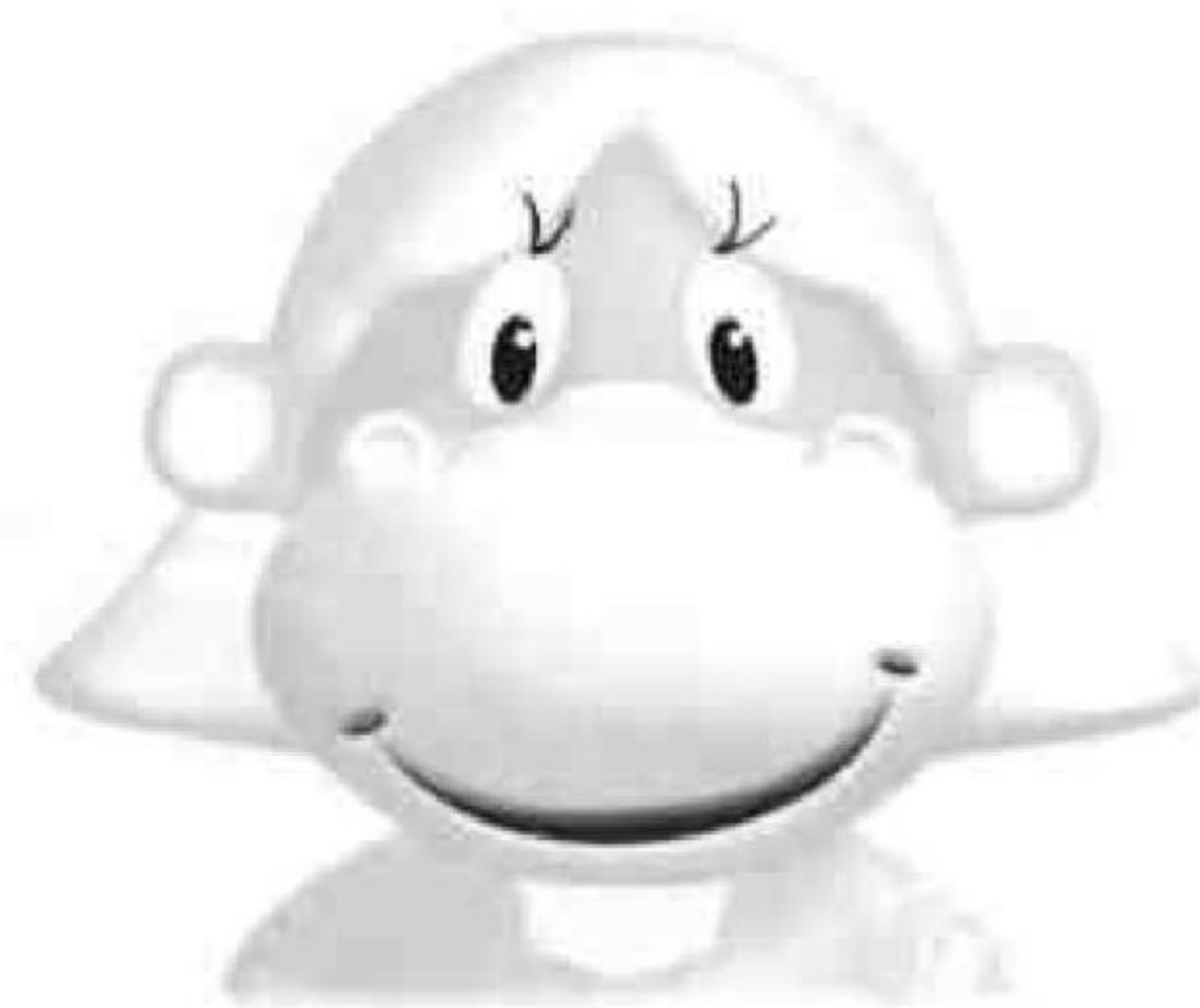

2

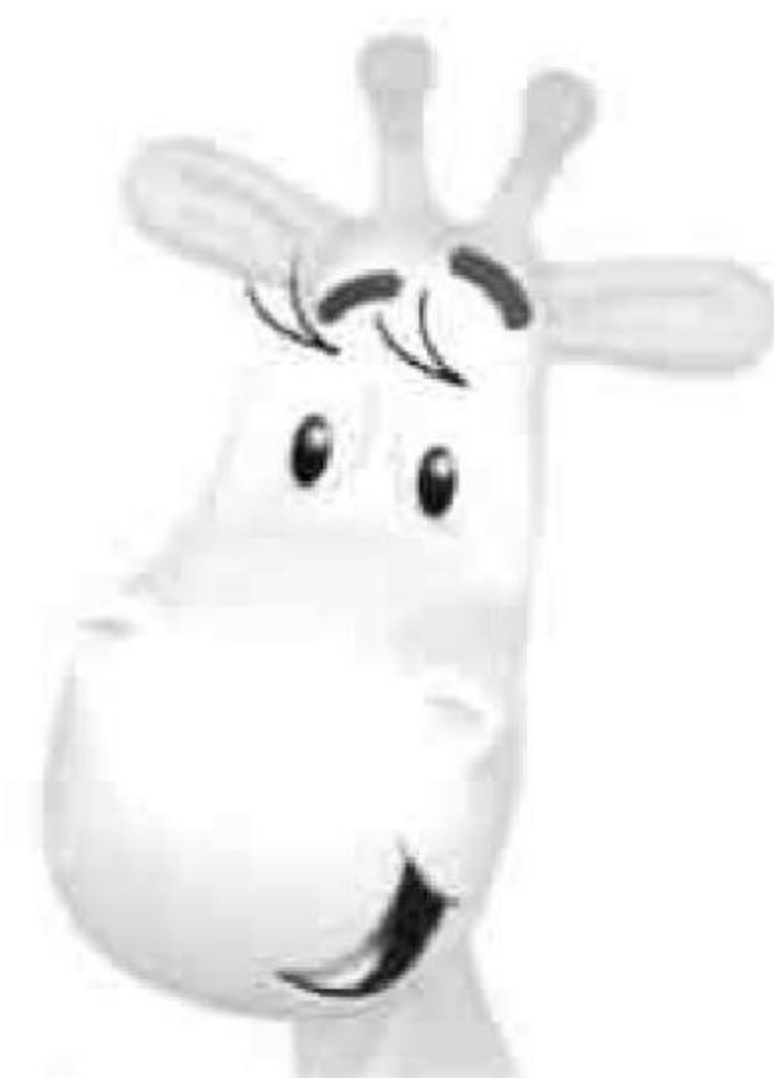

3



4



1 Think! Look and colour.

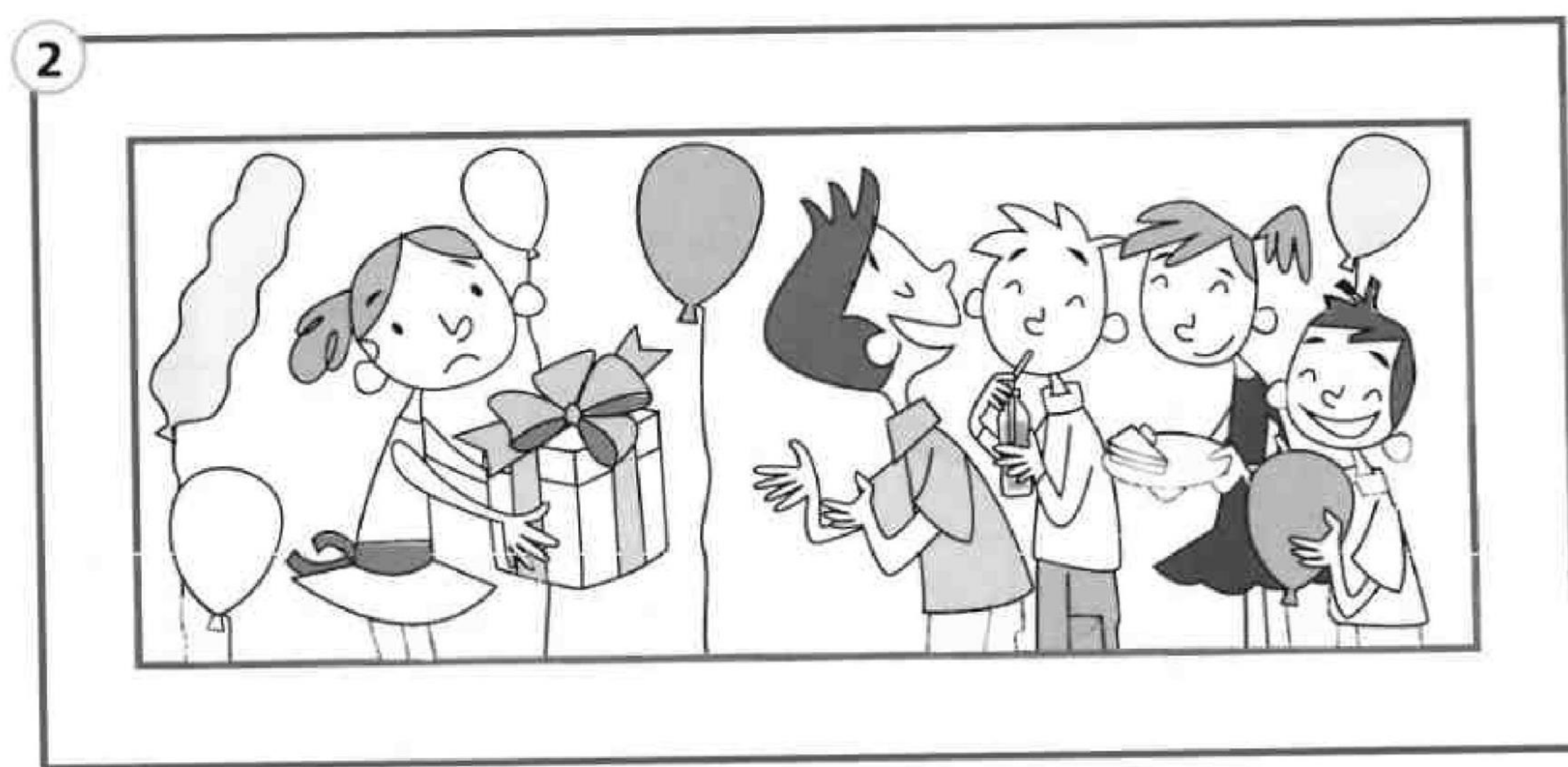

1 Trace with four colours to match.



2 Draw and say the shapes. □ △ □ ○

1

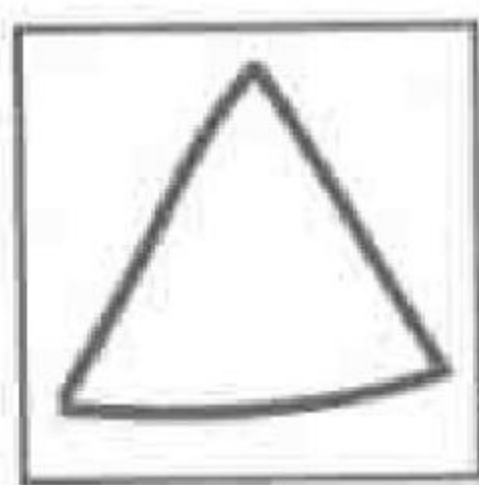
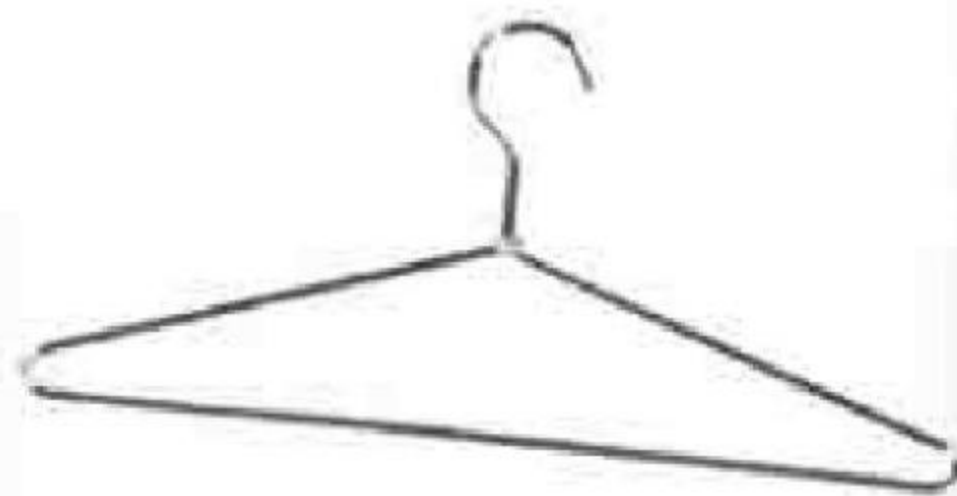

2

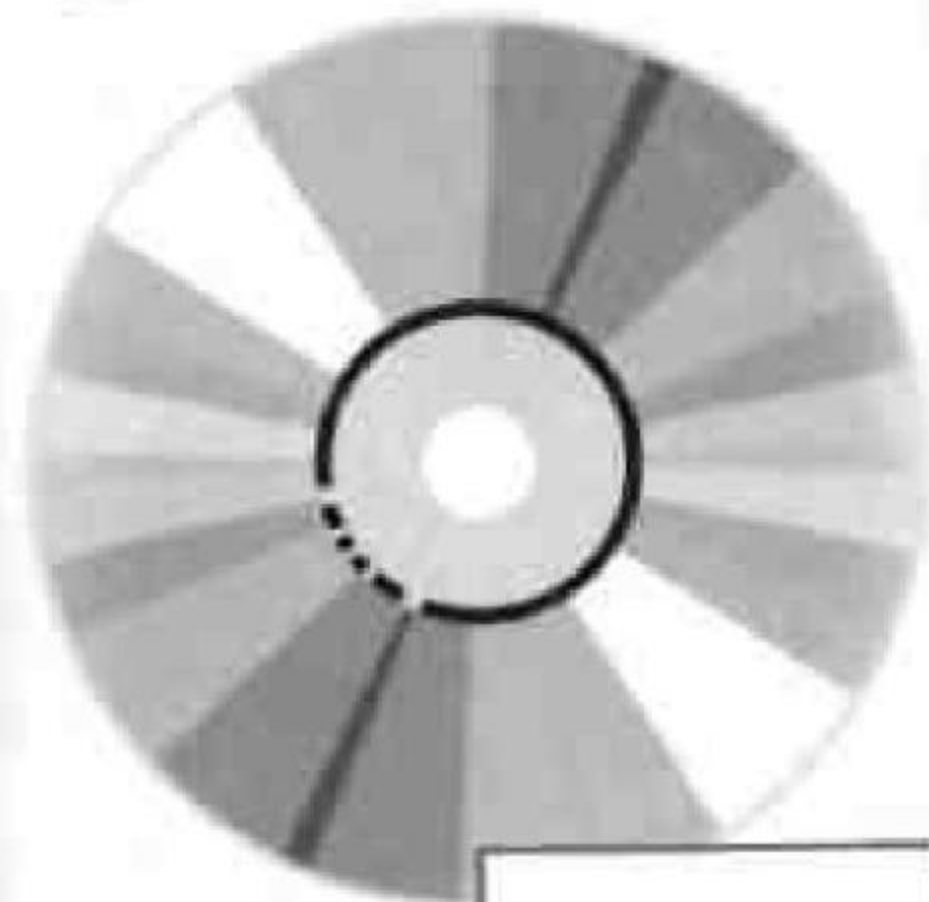

3

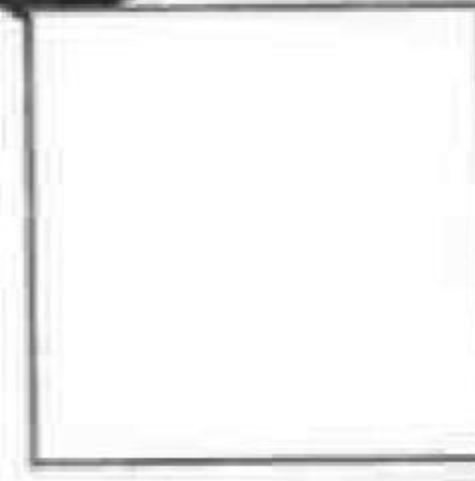

4



5



6

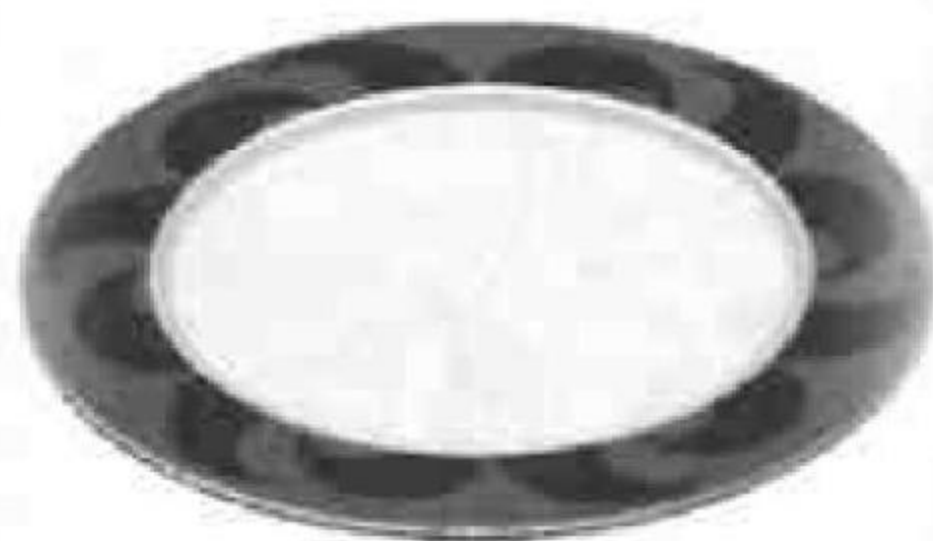

7

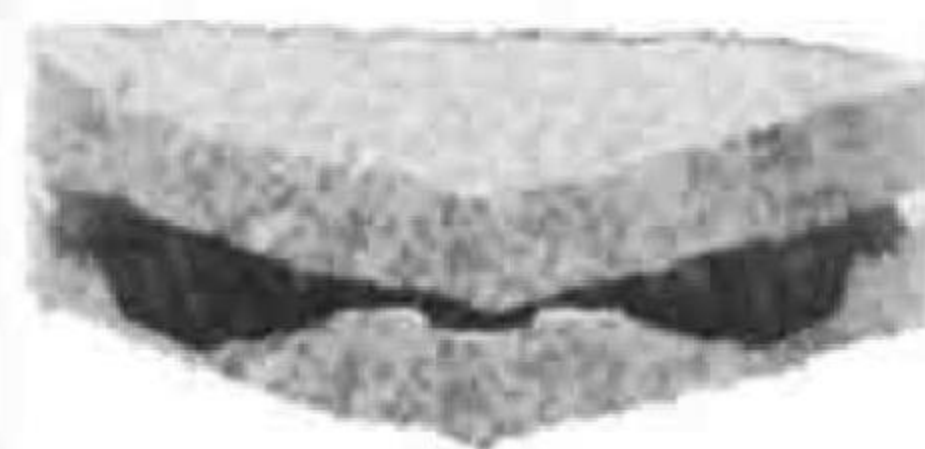

8



1 **Think!** Count and circle.

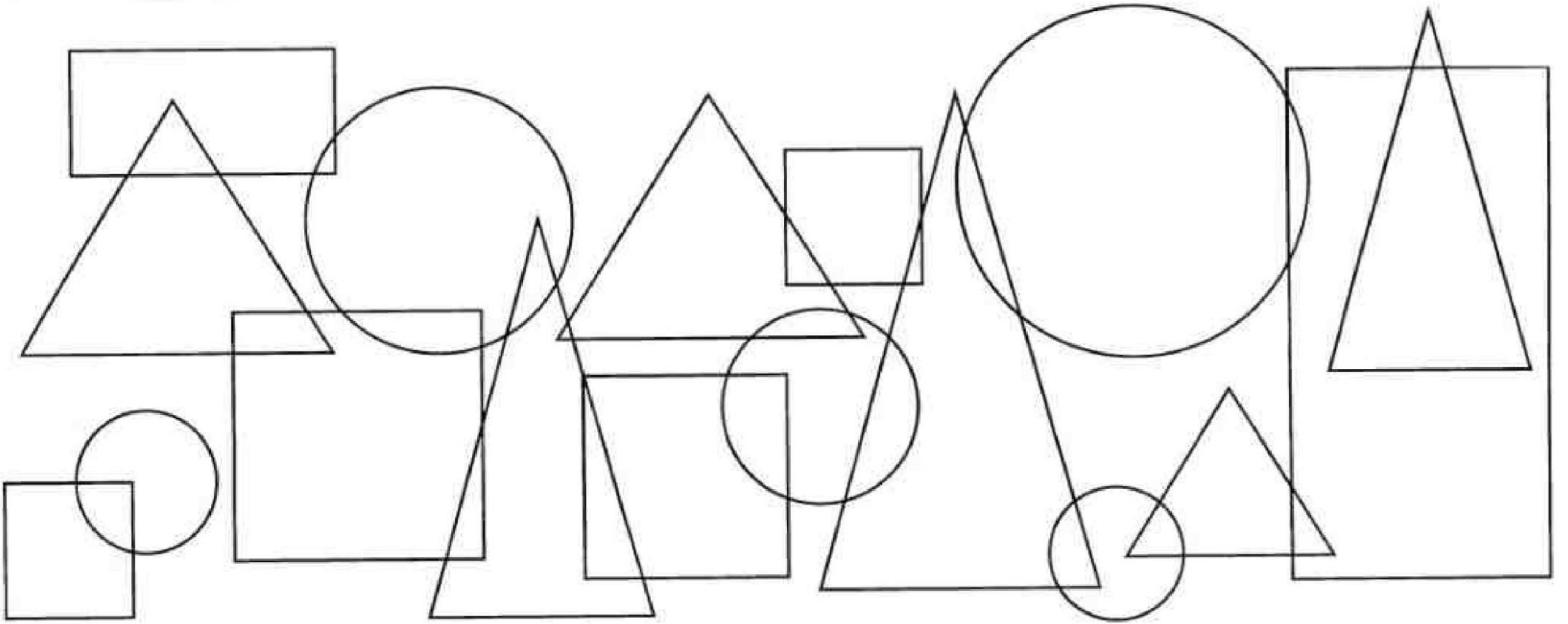

	1	2	3	4	5	6
--	---	---	---	---	---	---

	1	2	3	4	5	6
---	---	---	---	---	---	---

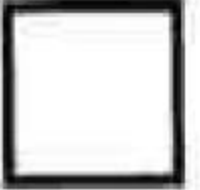
	1	2	3	4	5	6
--	---	---	---	---	---	---

	1	2	3	4	5	6
---	---	---	---	---	---	---

2 **CD2** Listen and colour.
46

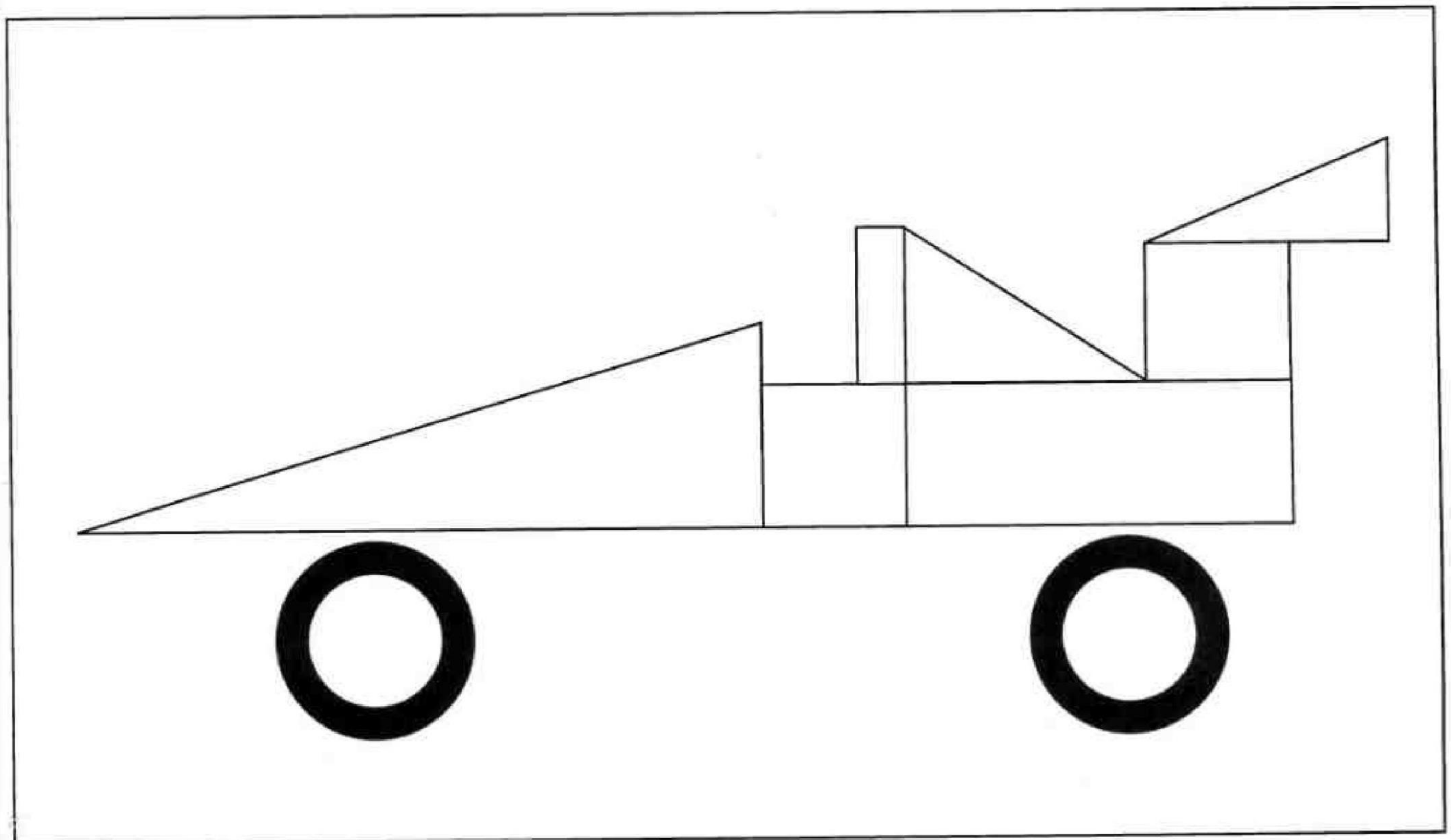

1

Have a boat race.



1



2



3

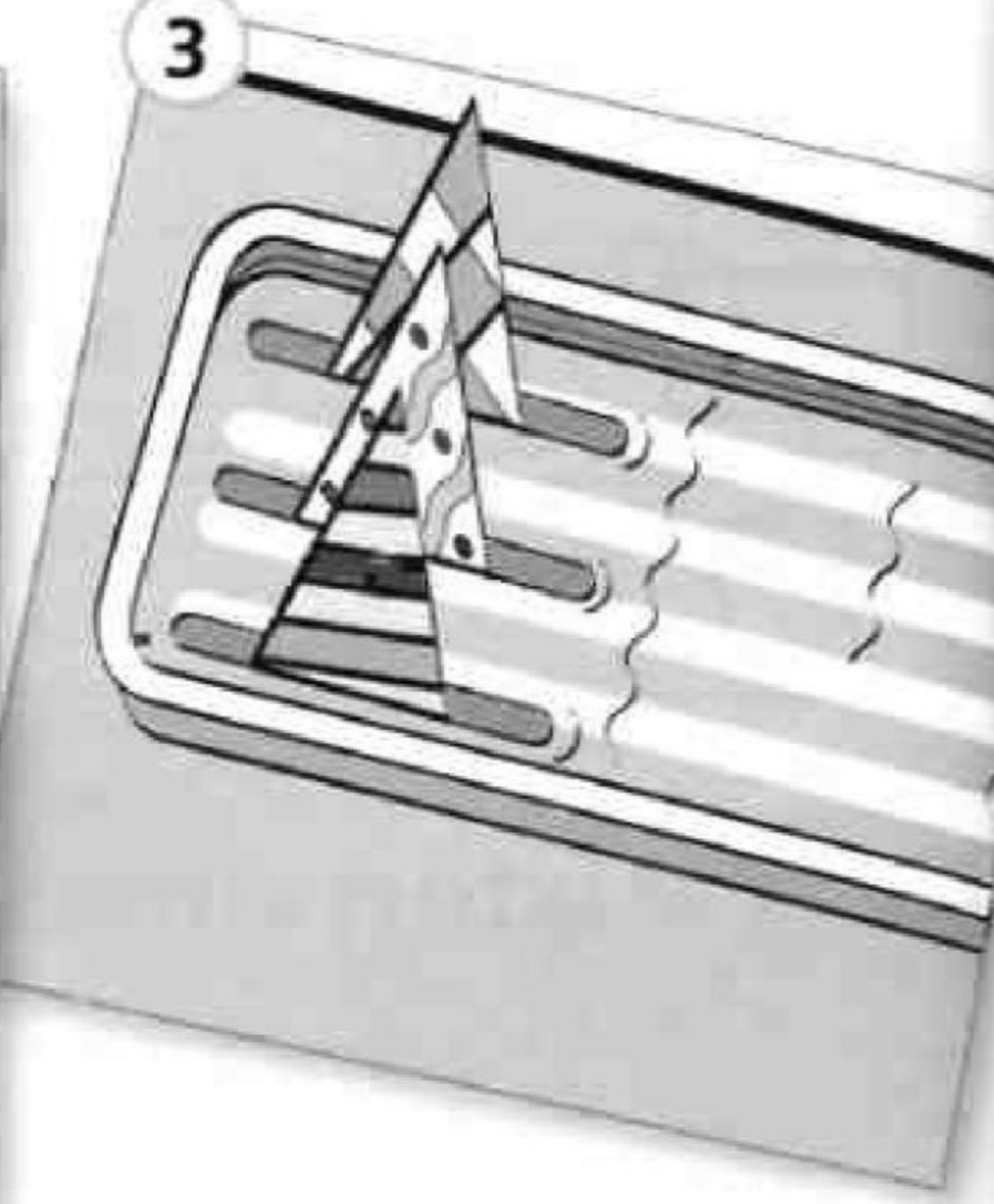

1 Say the words and trace. Colour the circles.



boat

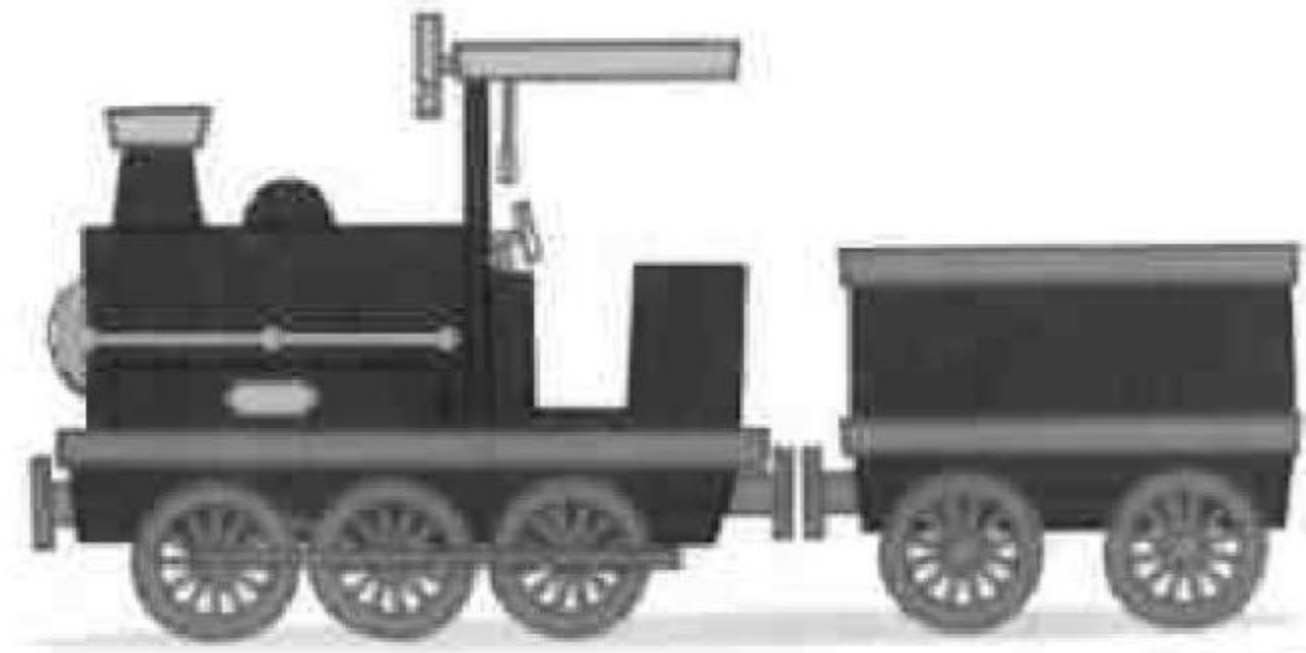

train

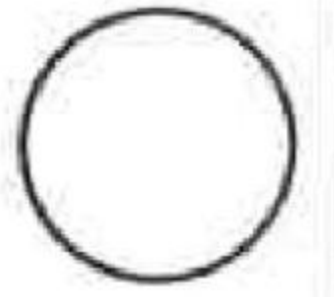

car



bike

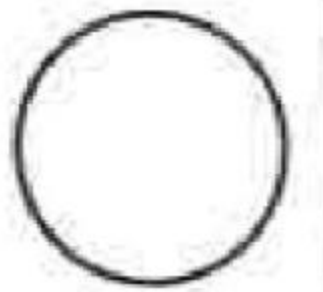

scooter

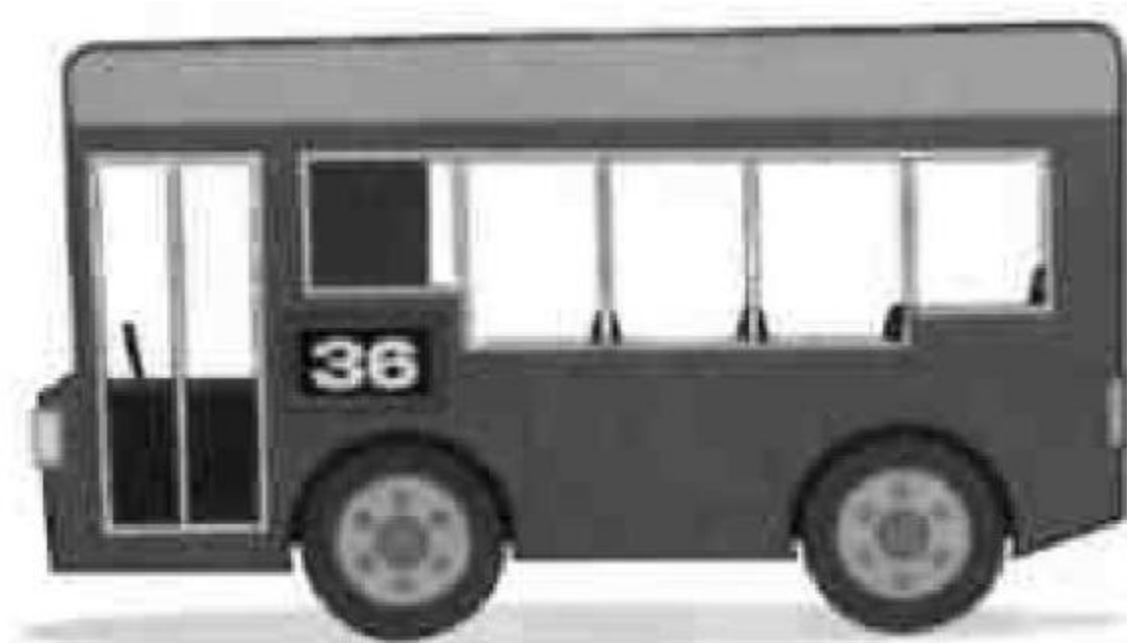
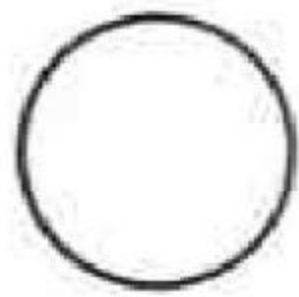

bus

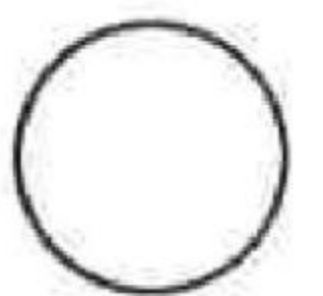

2 Draw faces. 😊 😐 😞

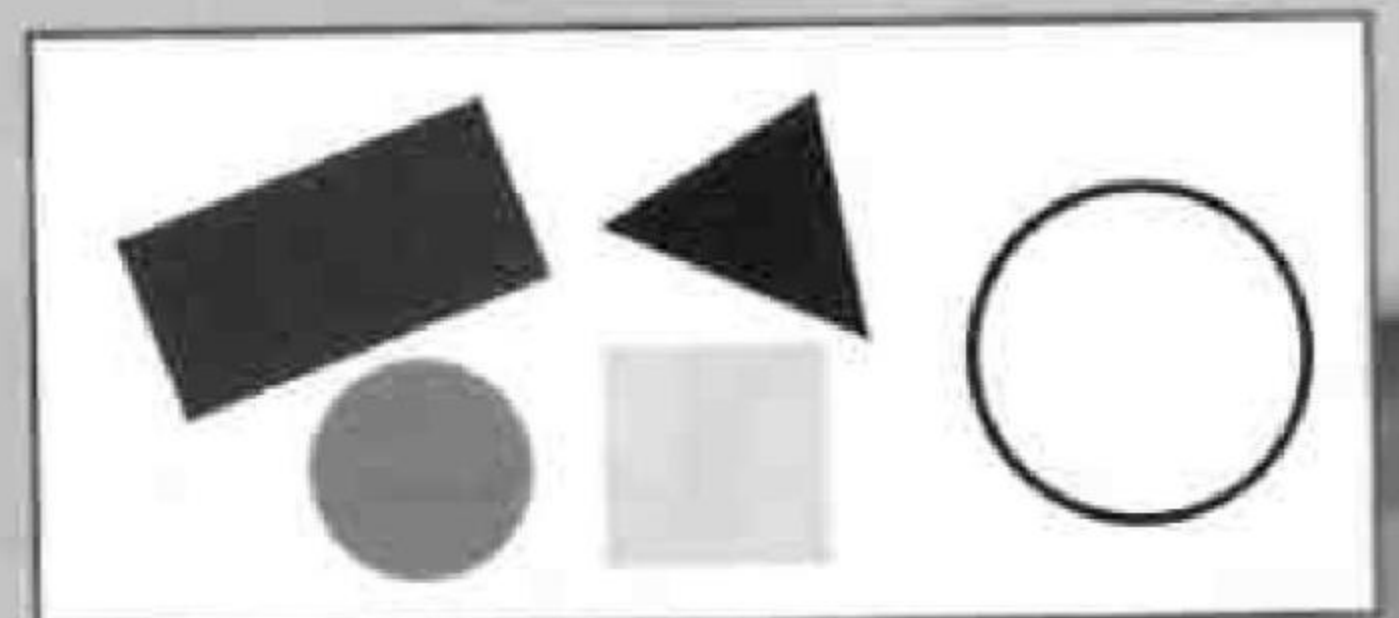
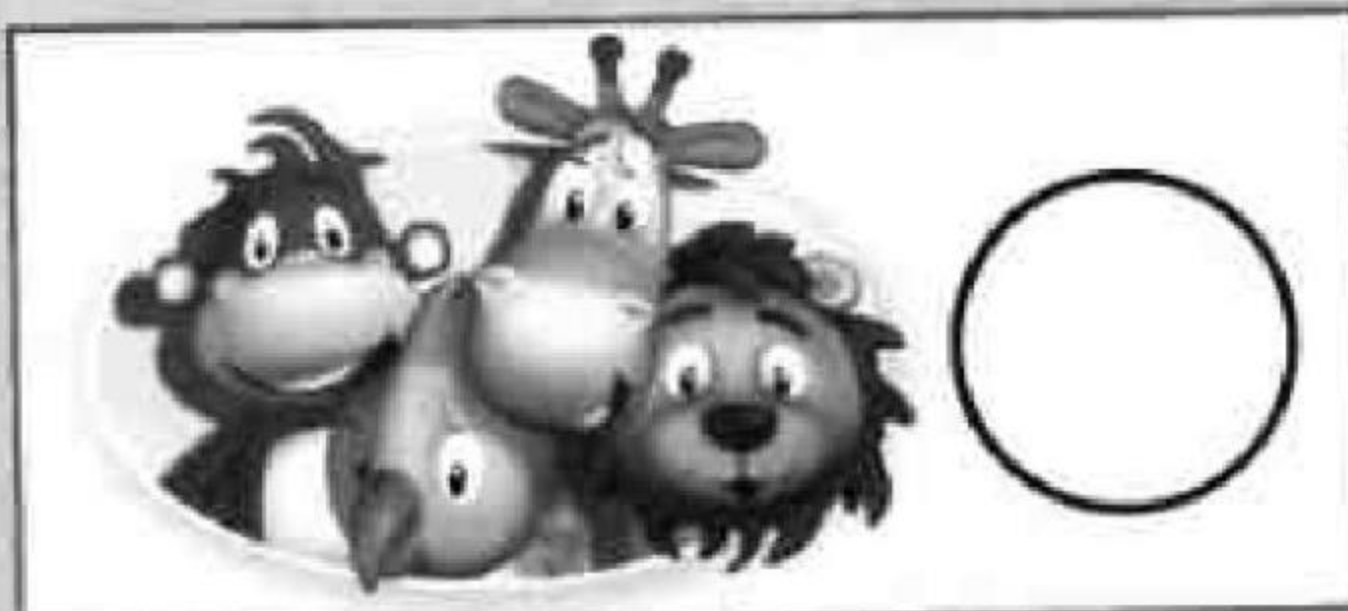

1 Colour and describe.

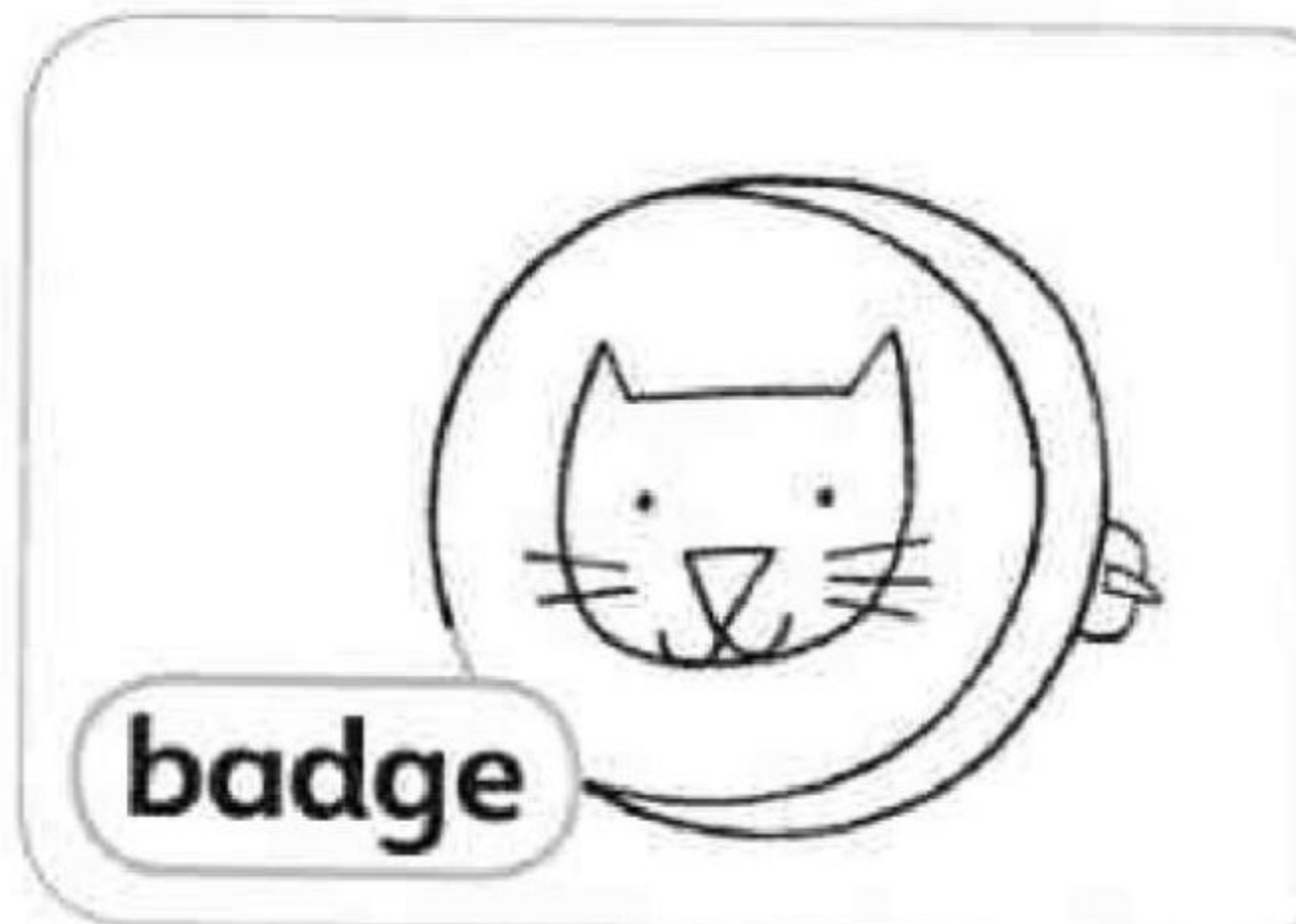
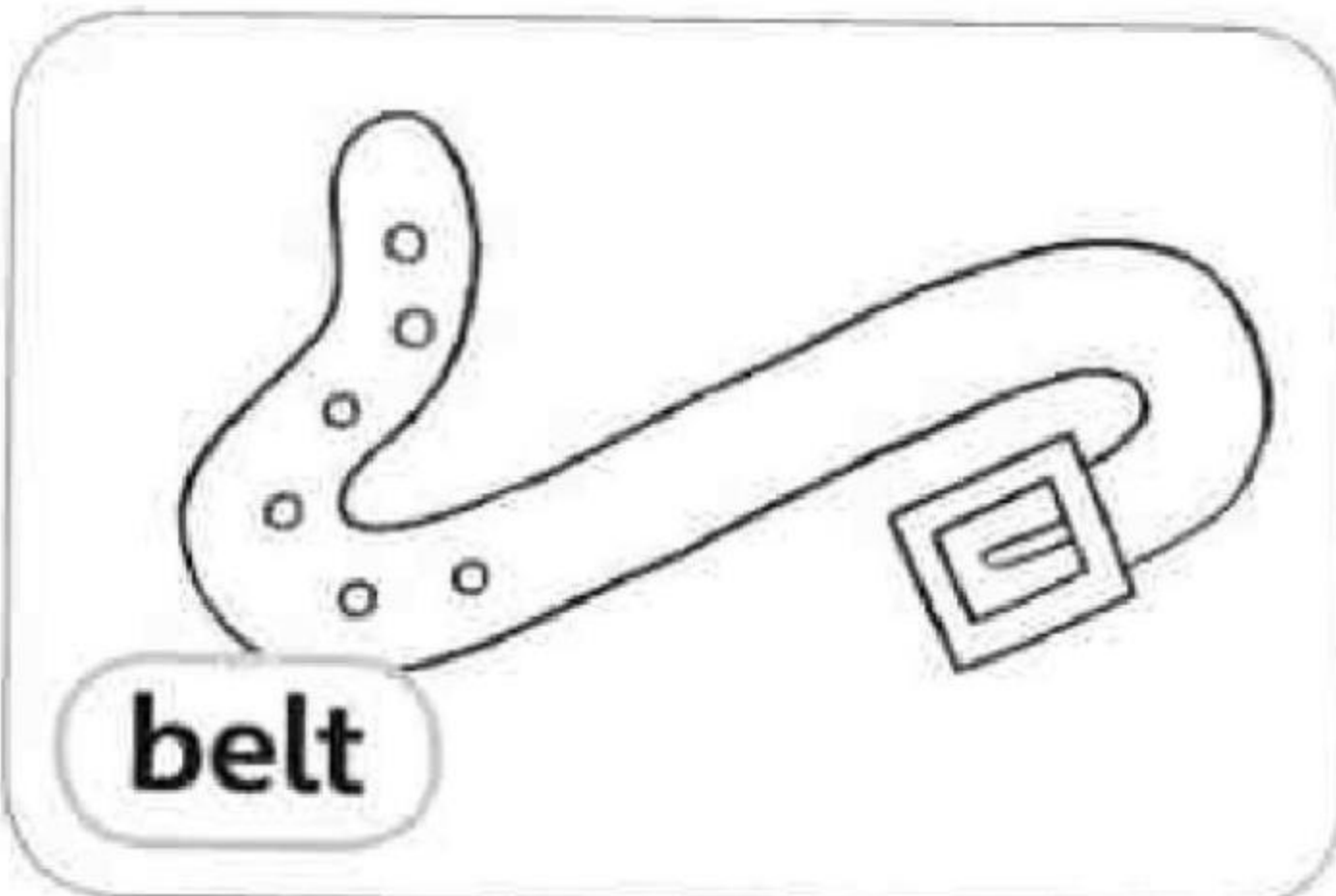
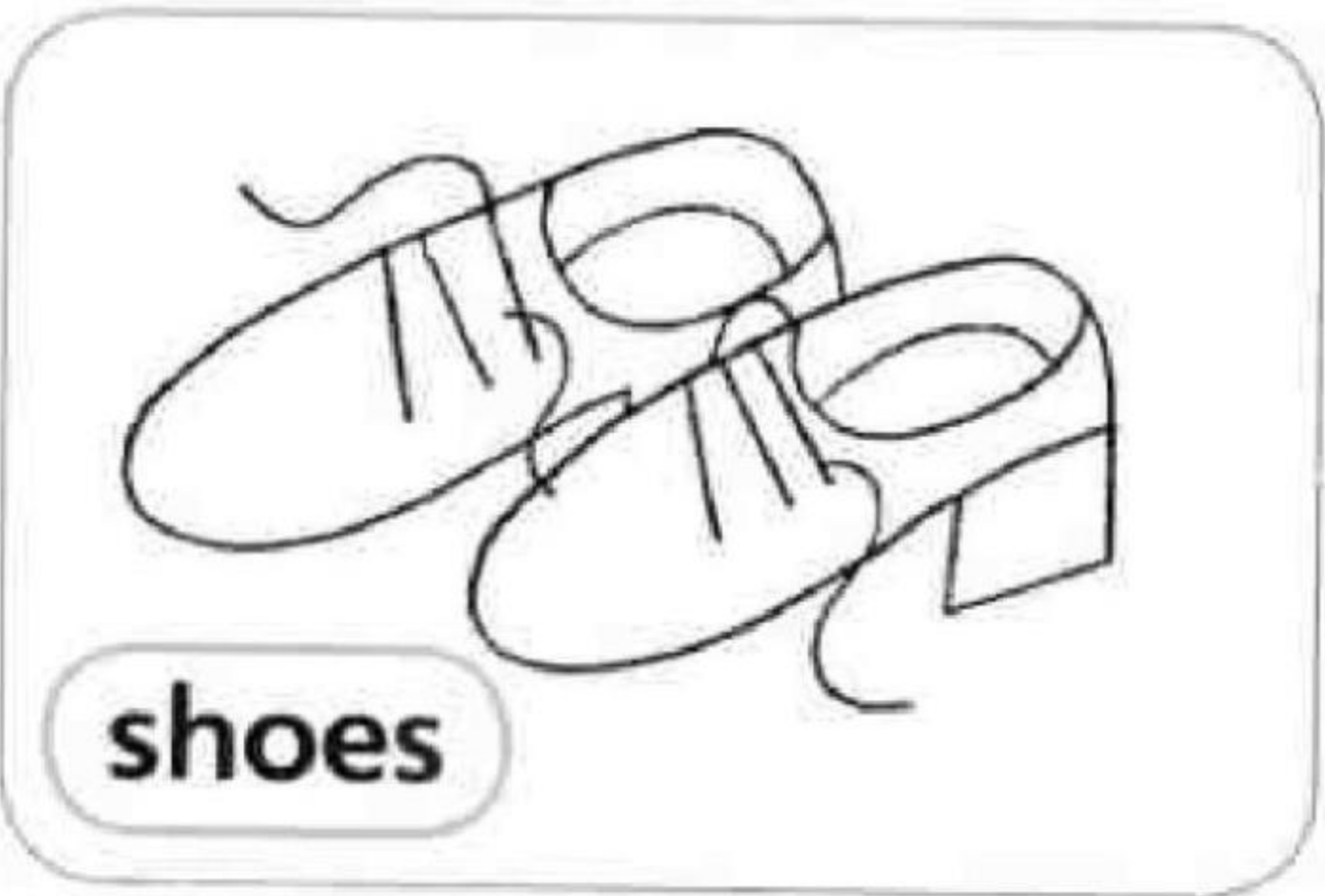
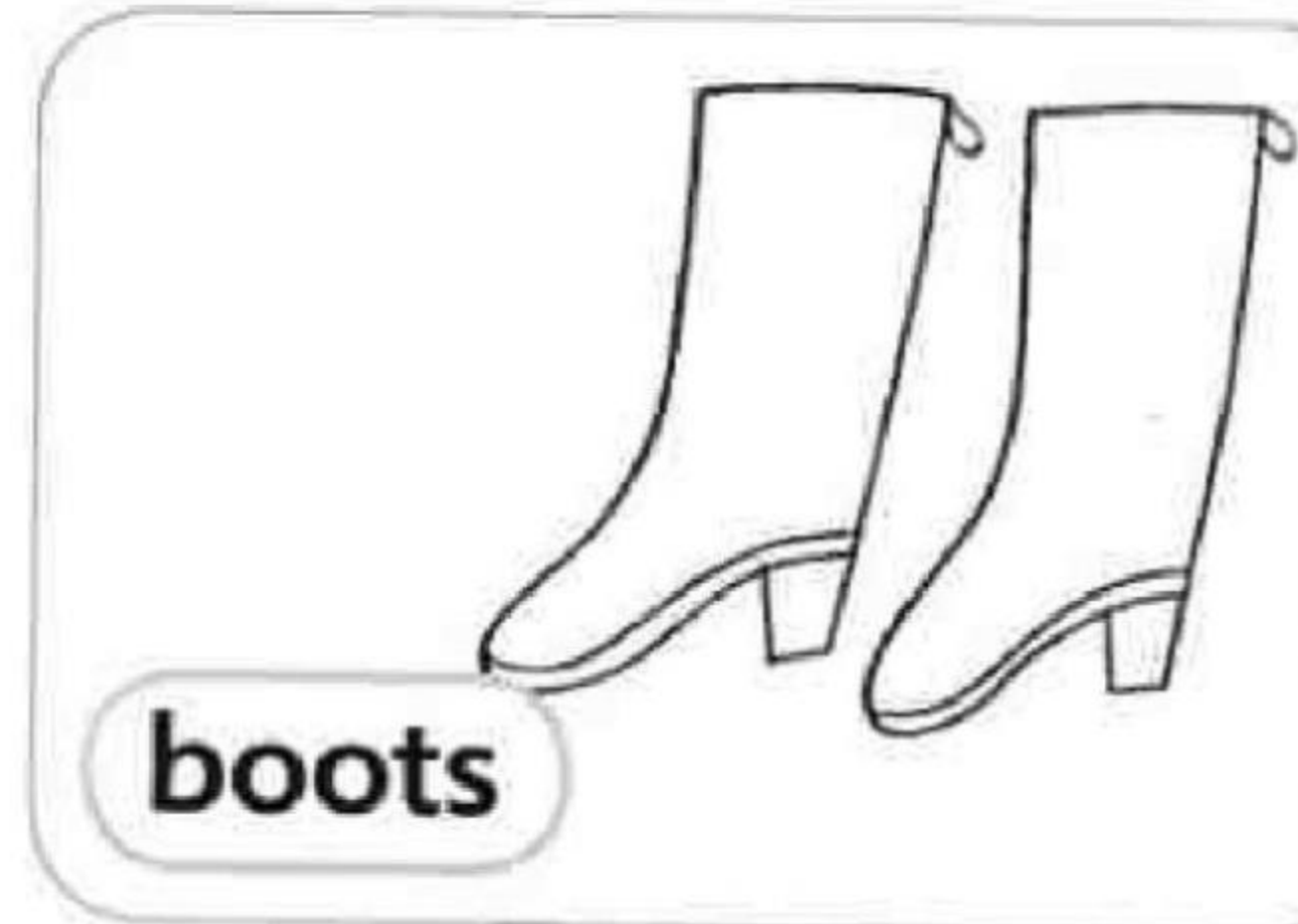
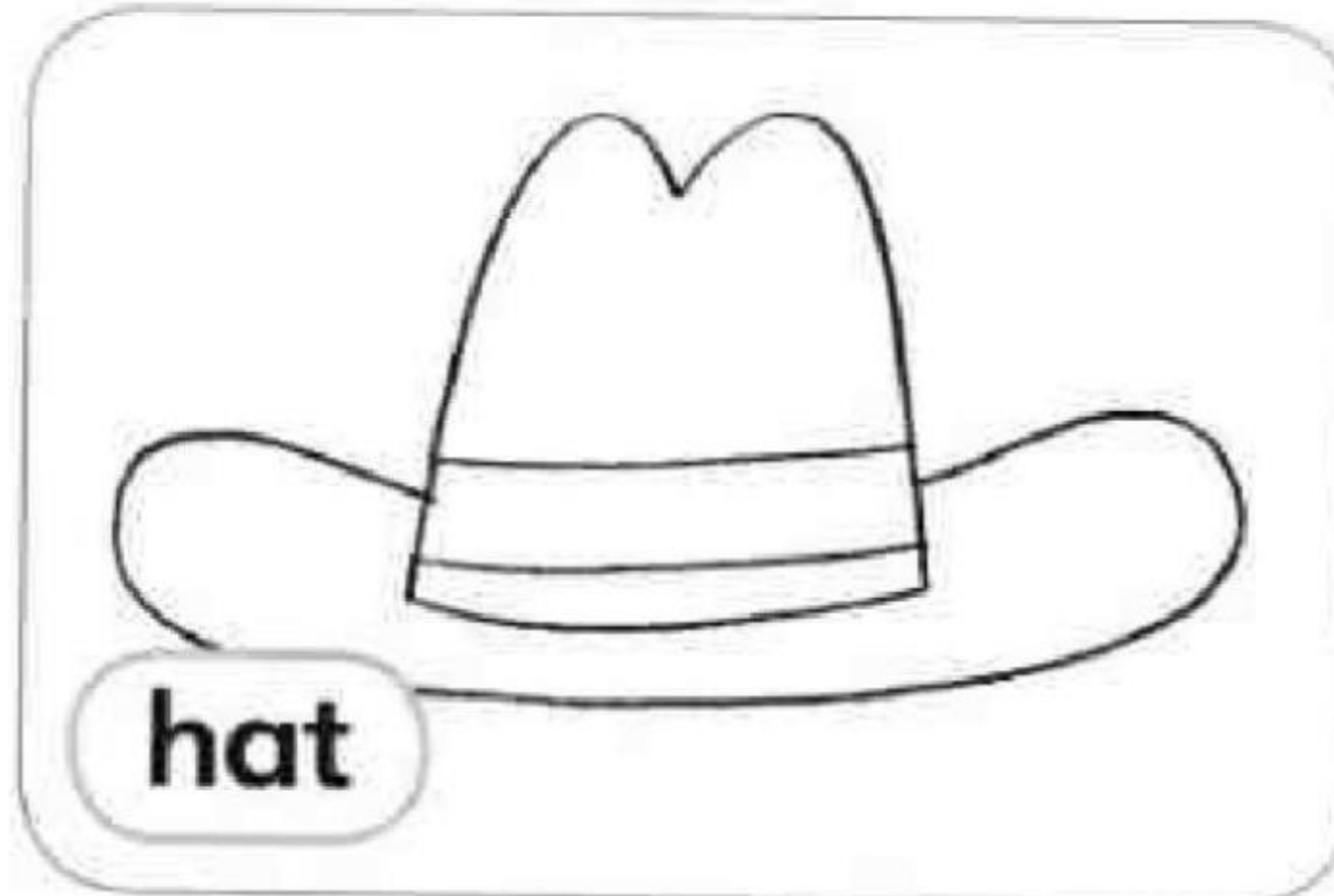
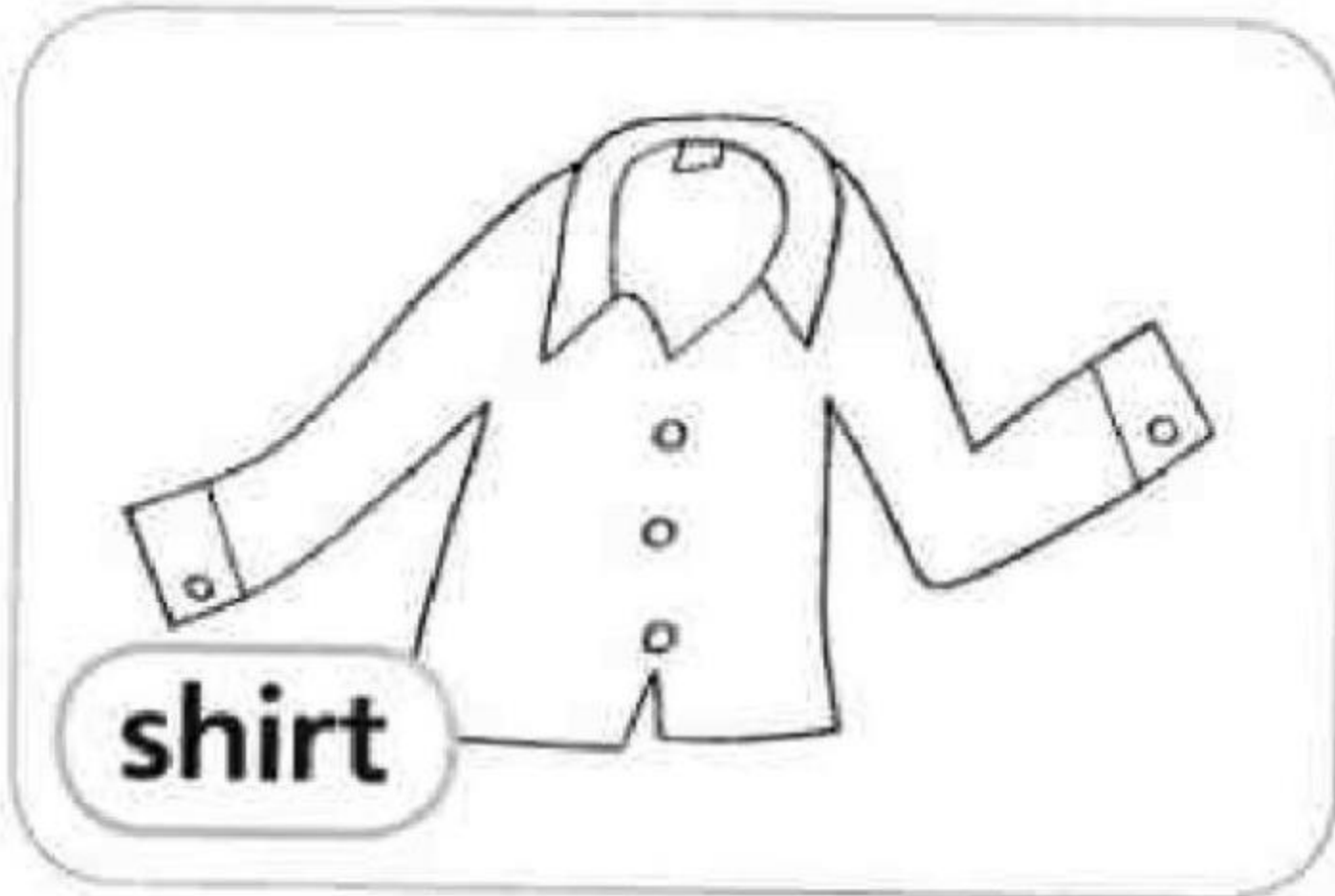

2 Draw five lines. Guess with your friend.

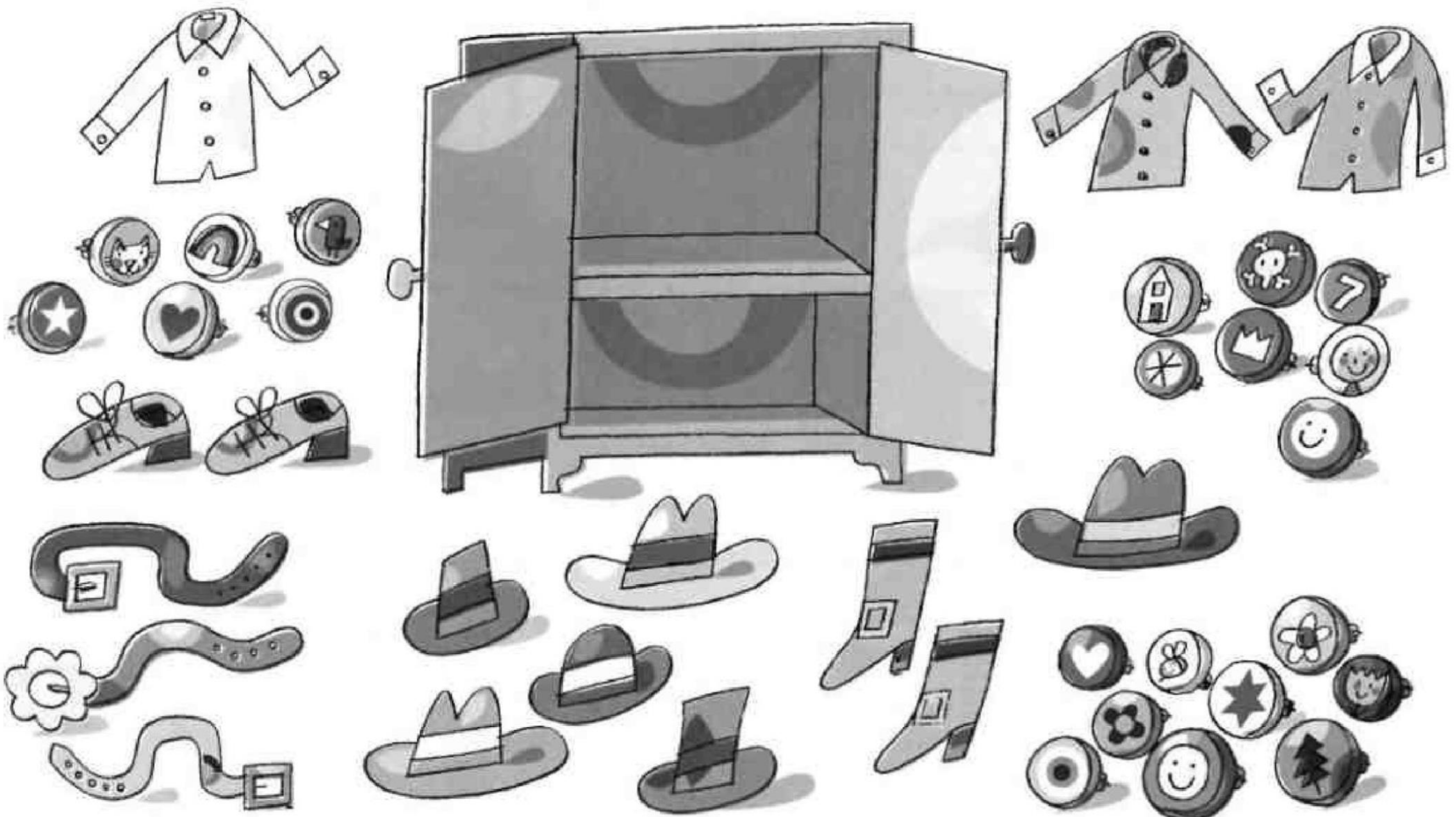

1 Think!

Follow the food and drink.



I like (biscuits, crisps, salad, sweets).

1

Find five differences.

1

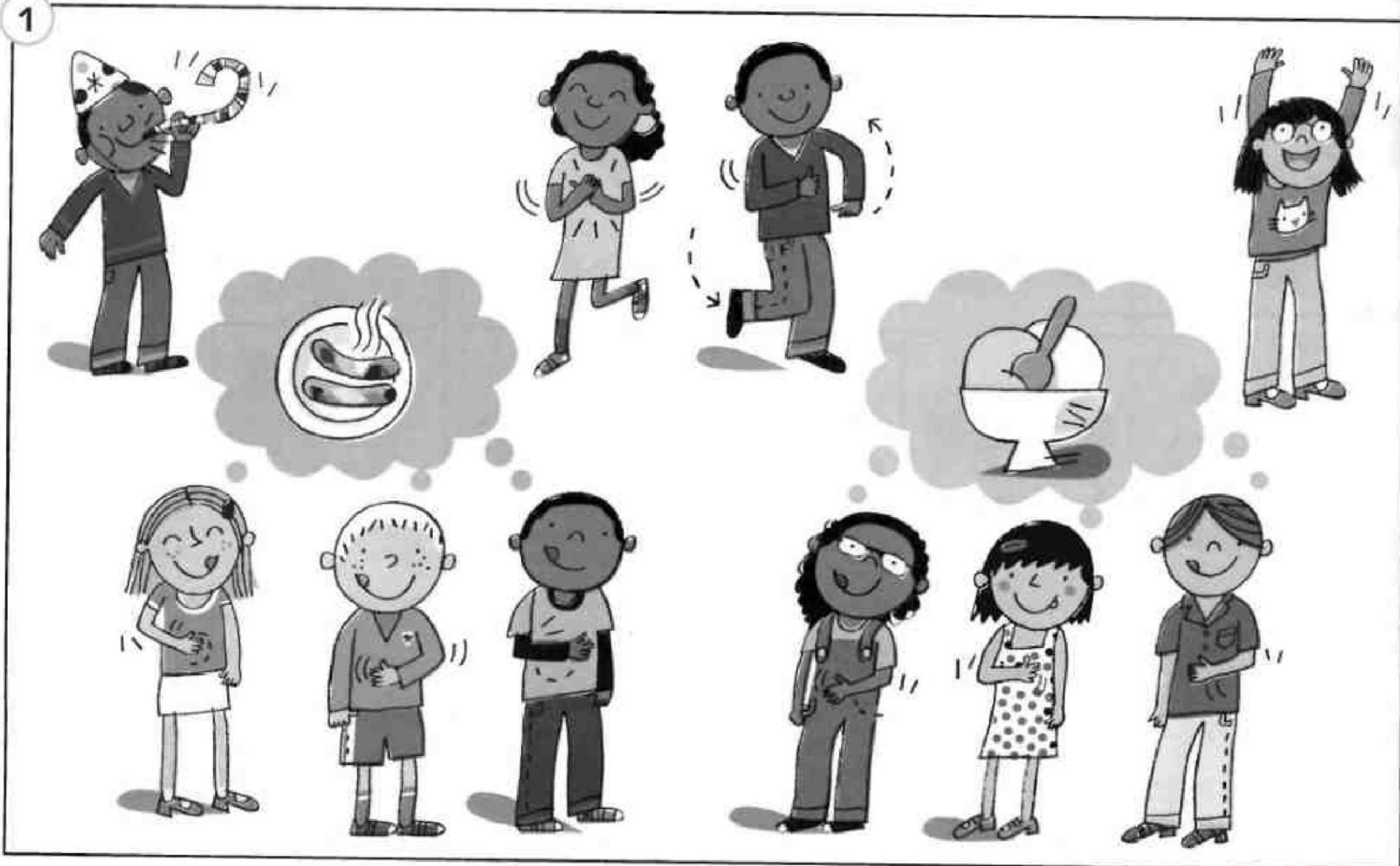

2

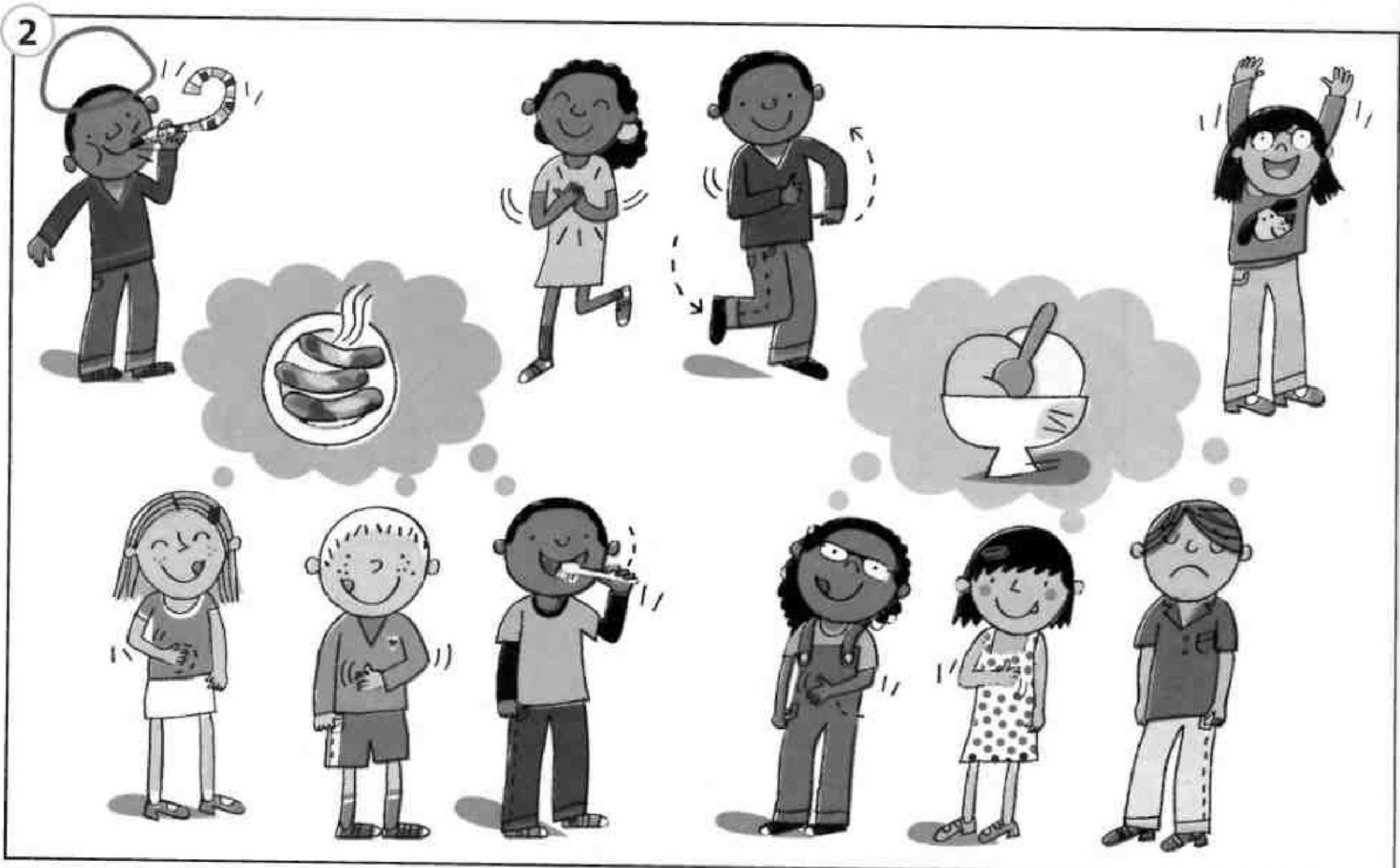

1 Think! Look and cross out.

1

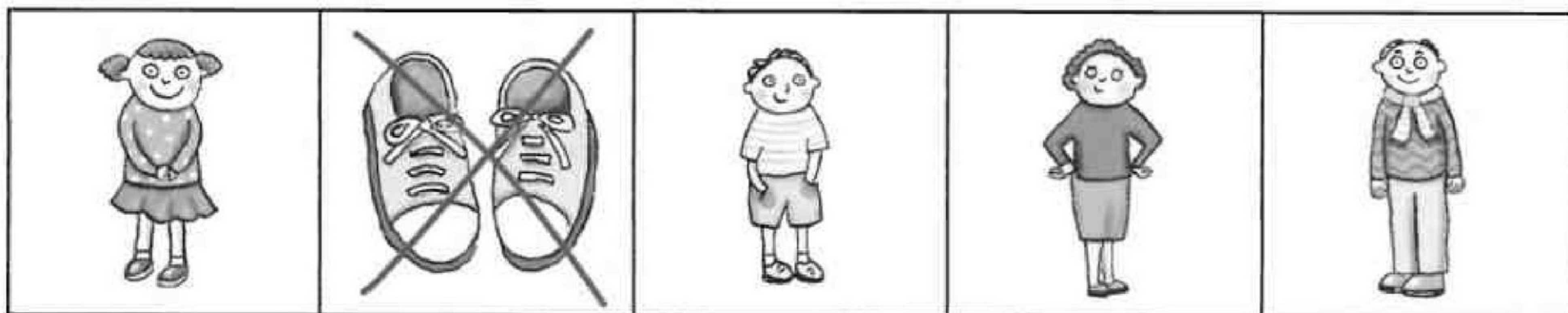

2

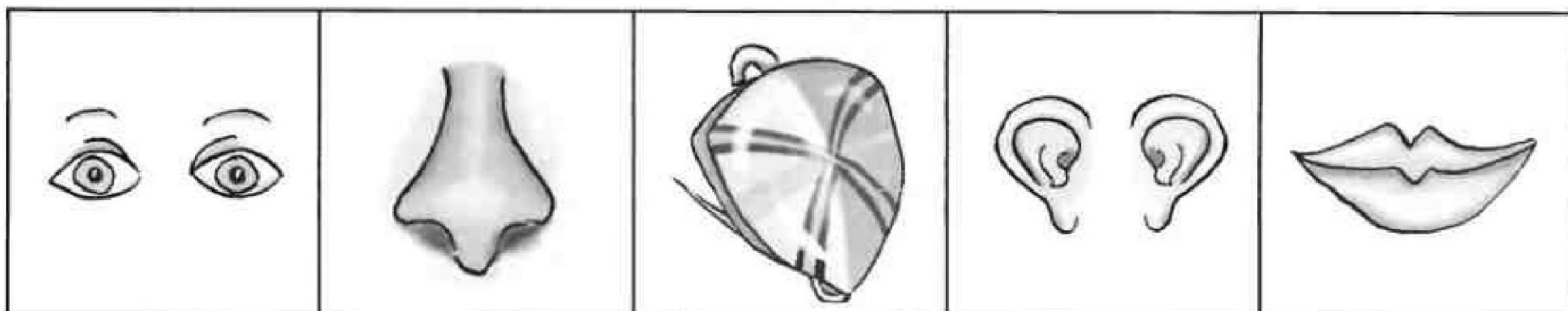

3

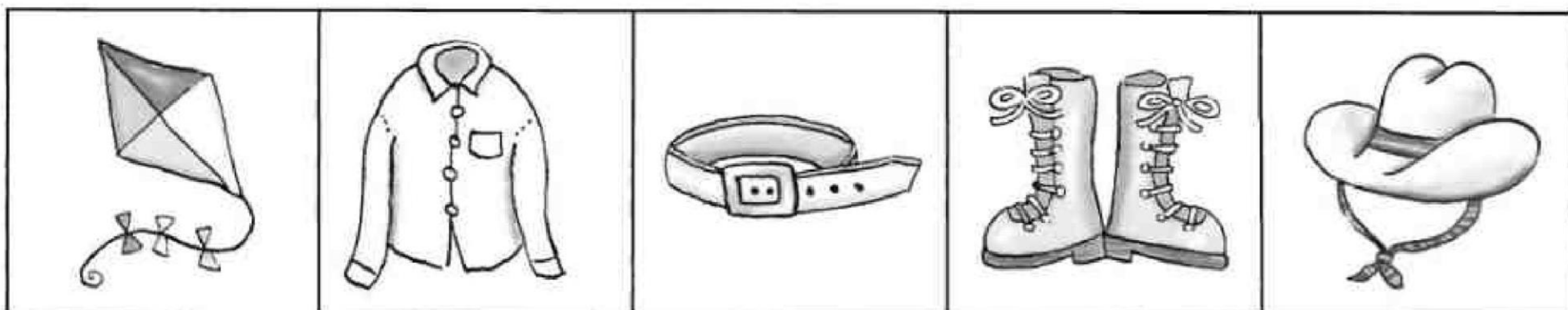

4

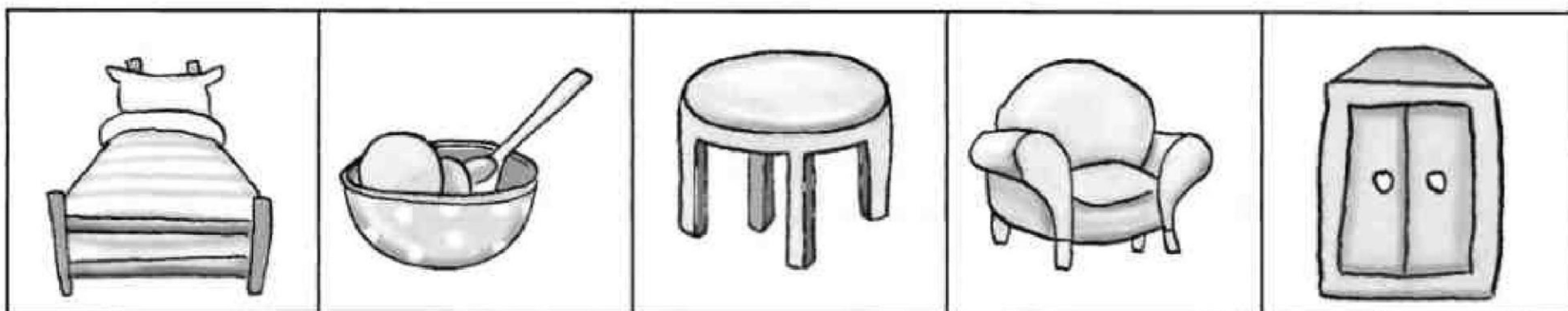

5

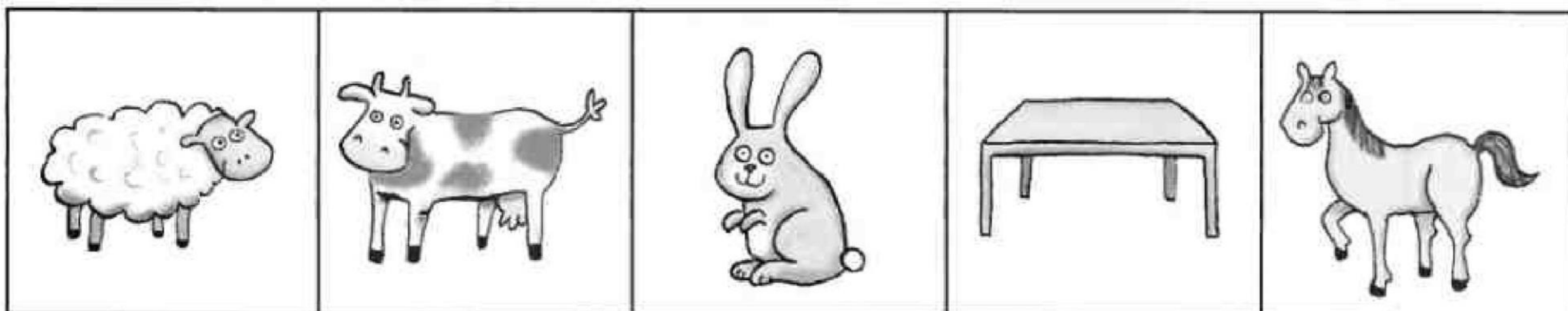

6

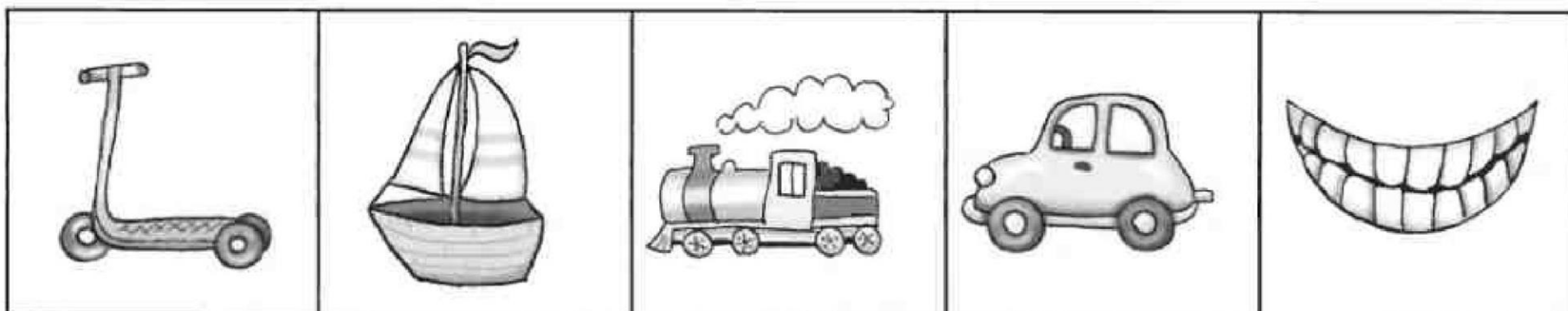

Listen and trace.

1

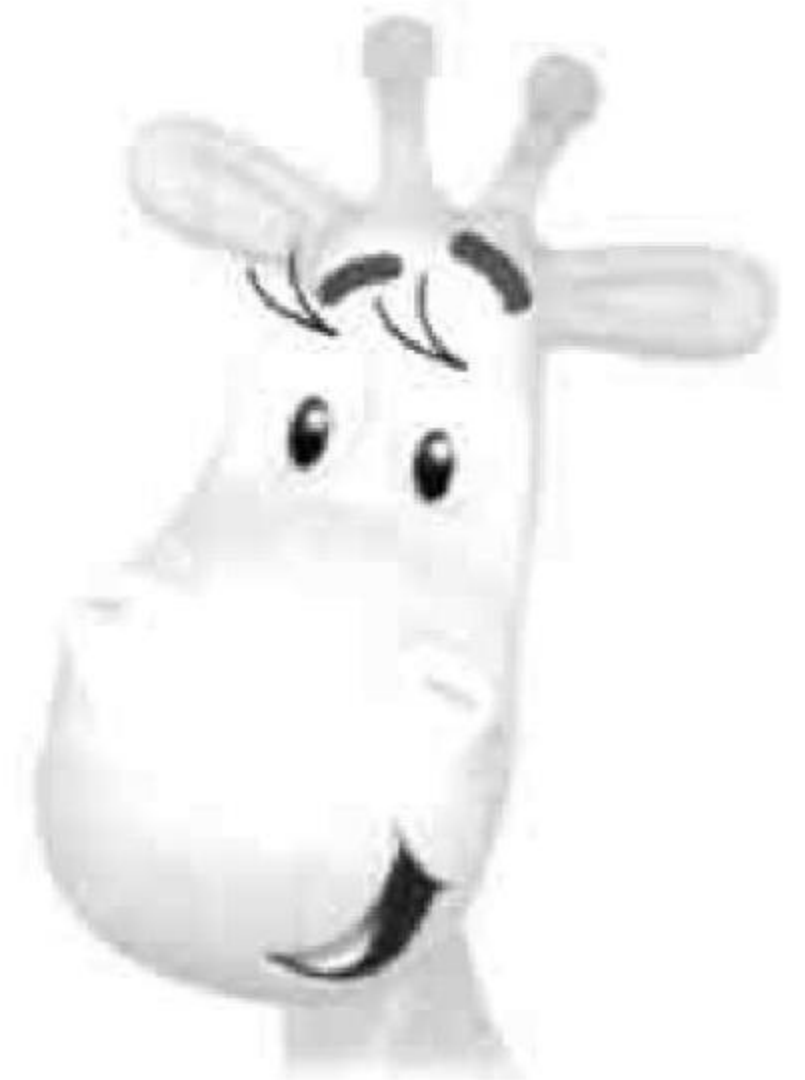

2



3

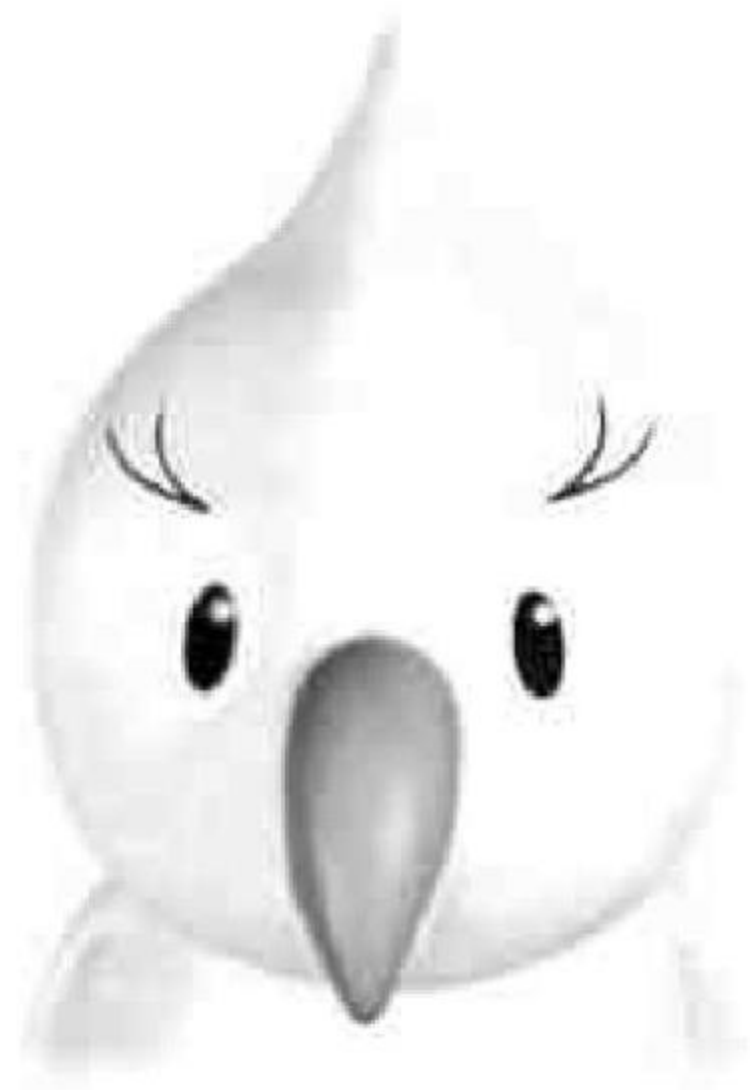

4

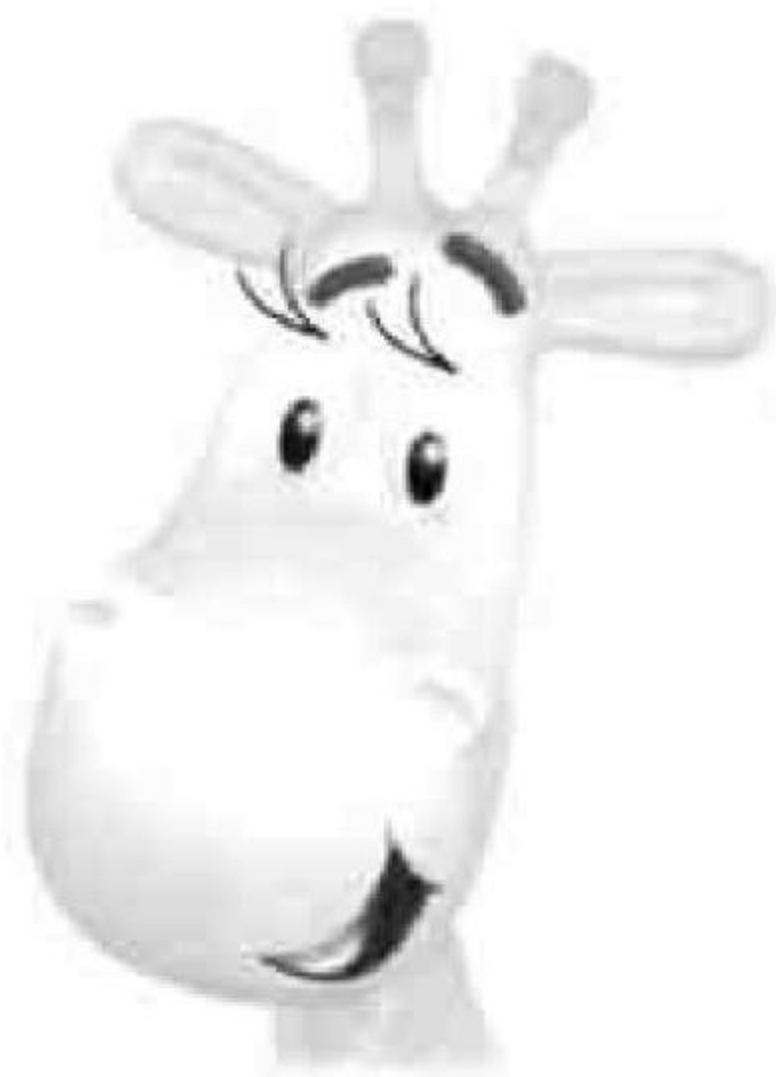

1 Think! Look and colour.



1

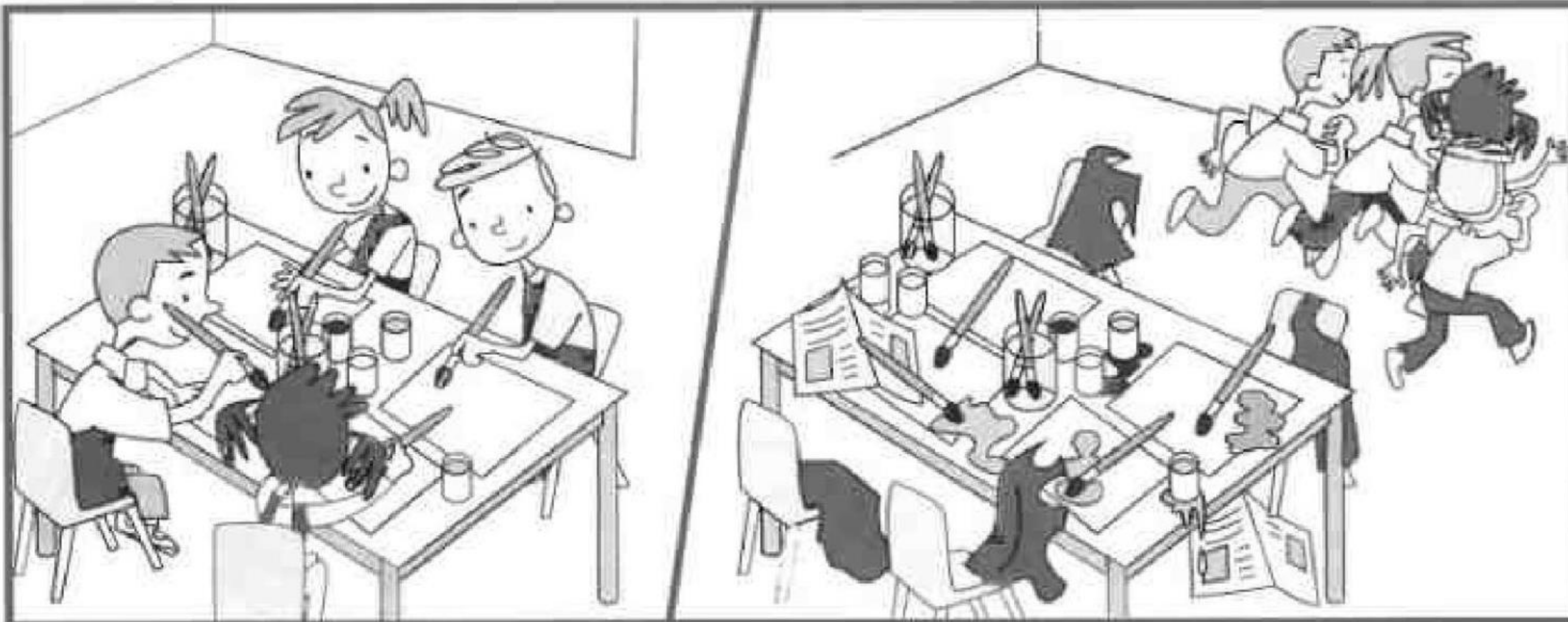

2

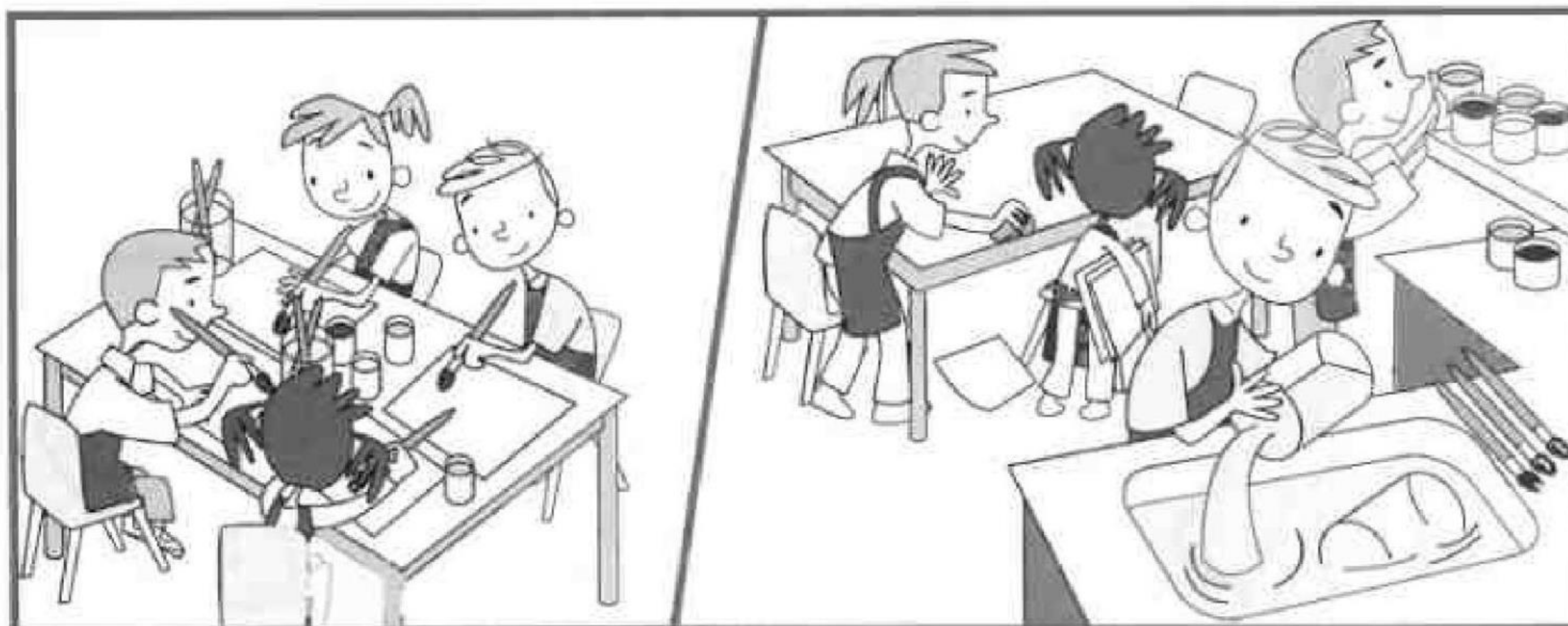

Listen and colour.



2

Think!

Look and colour.



1 Colour. Follow the lines. Describe the uniforms.



1 Make a pirate hat.

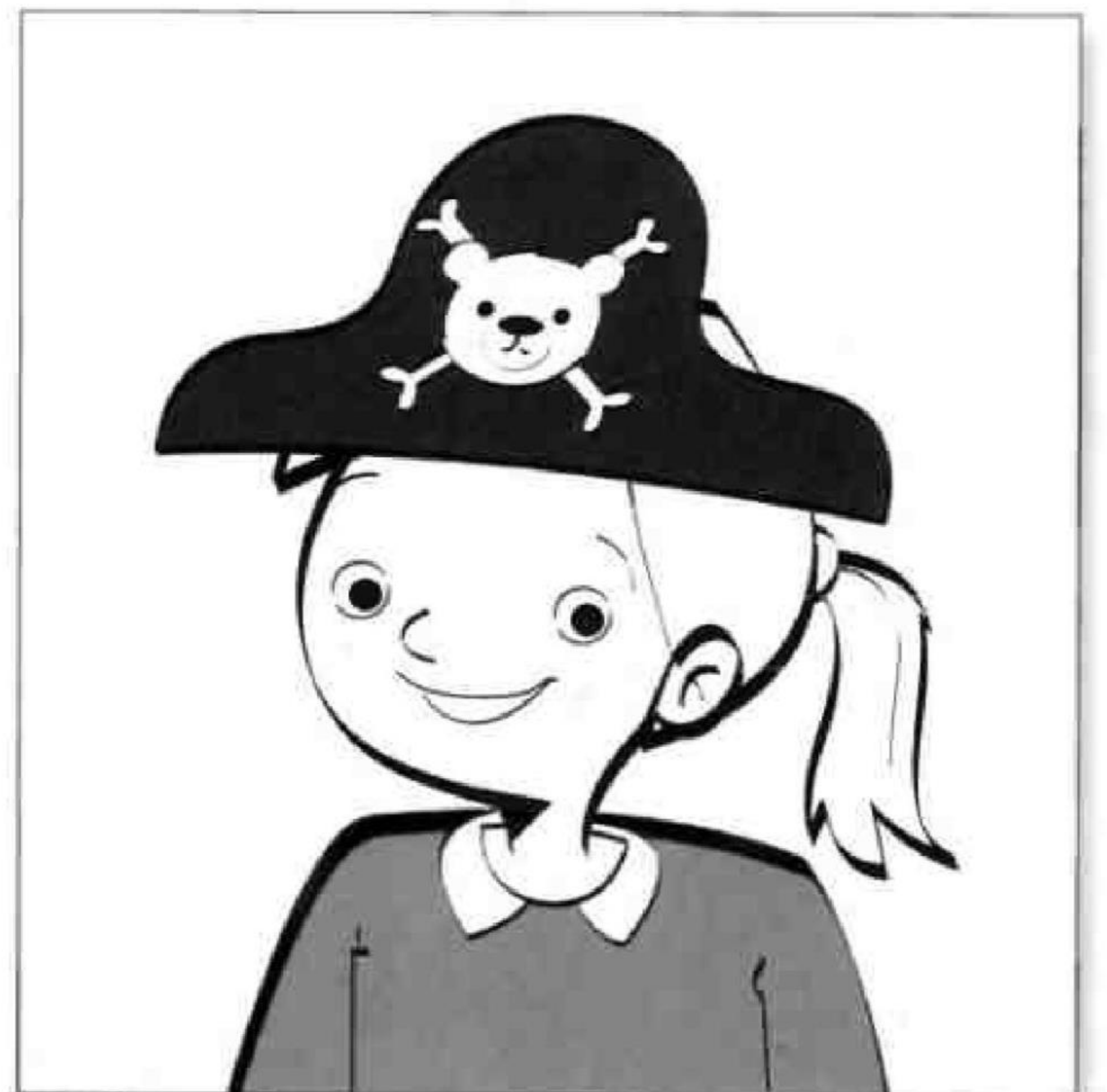
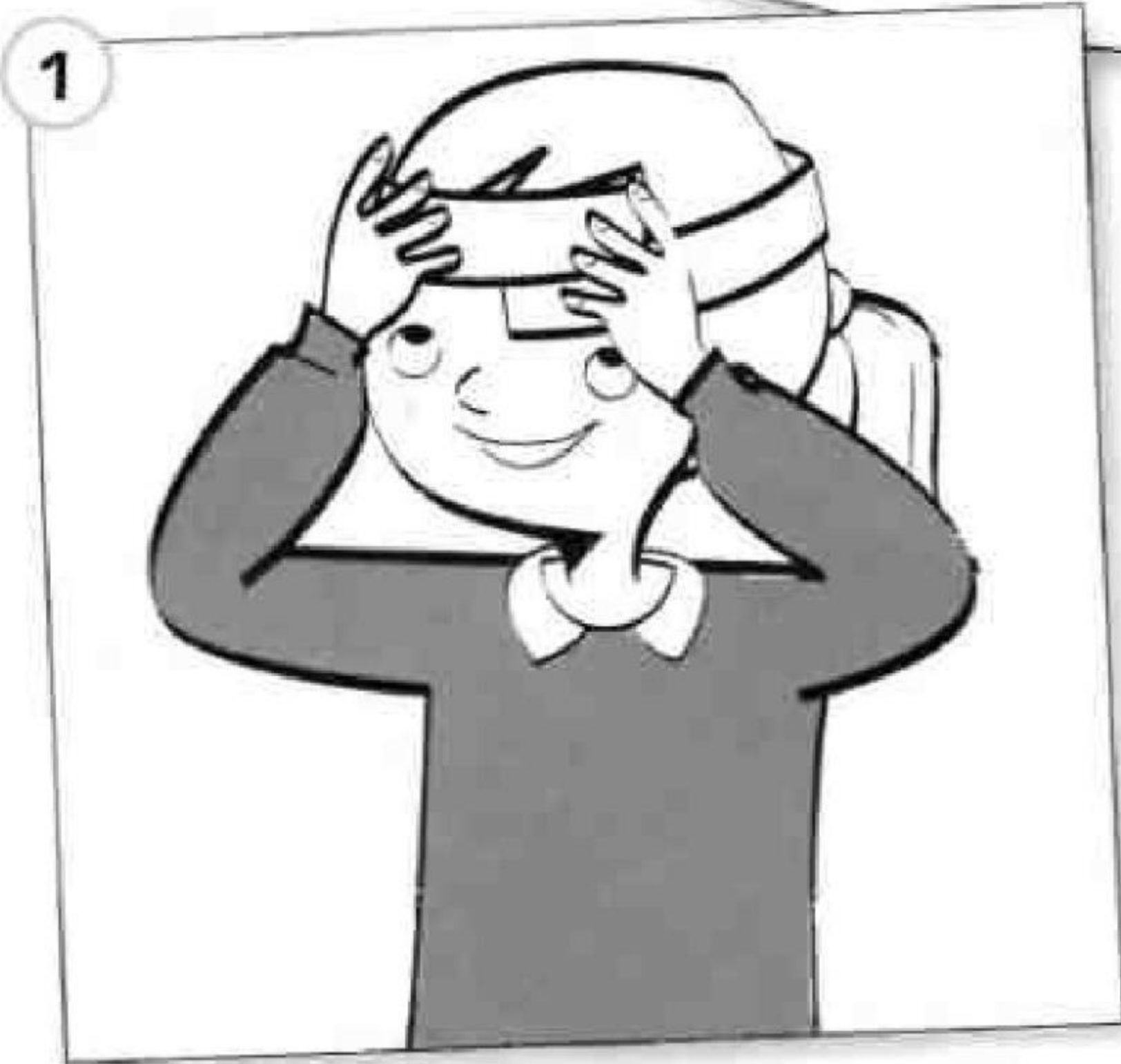
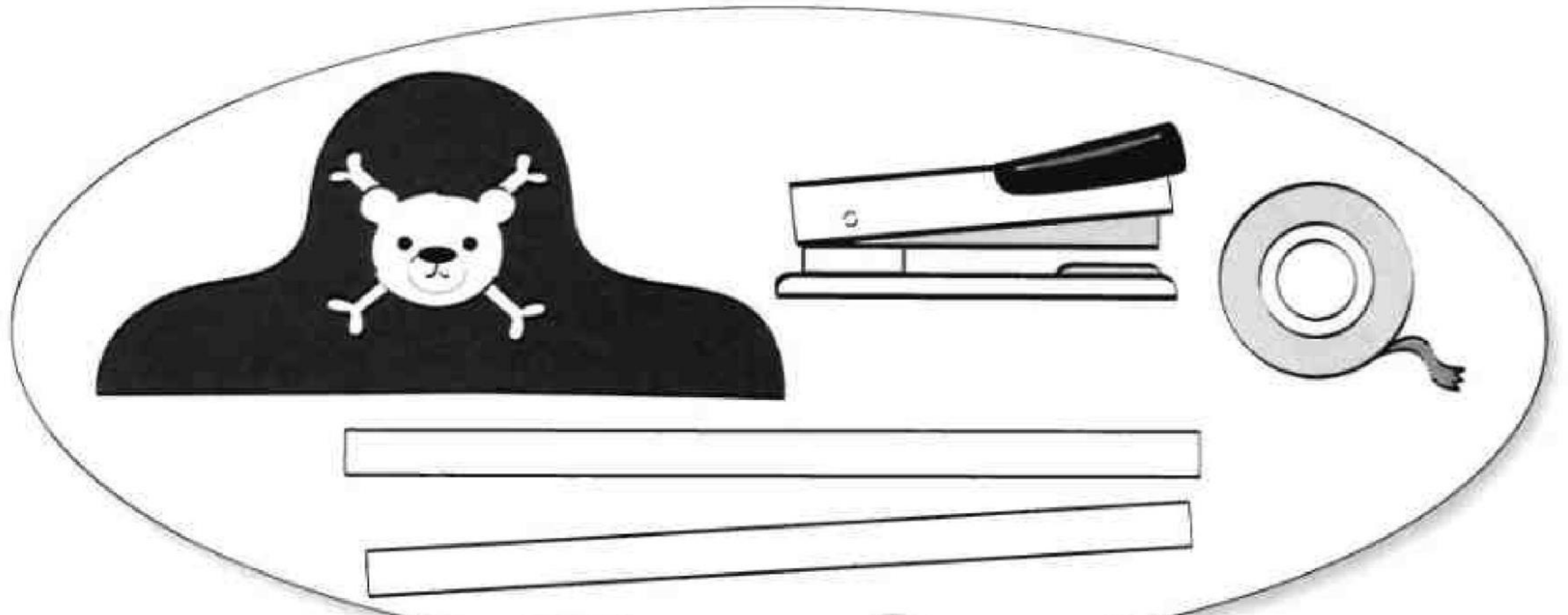

1 Say the words and trace. Colour the circles.



shirt

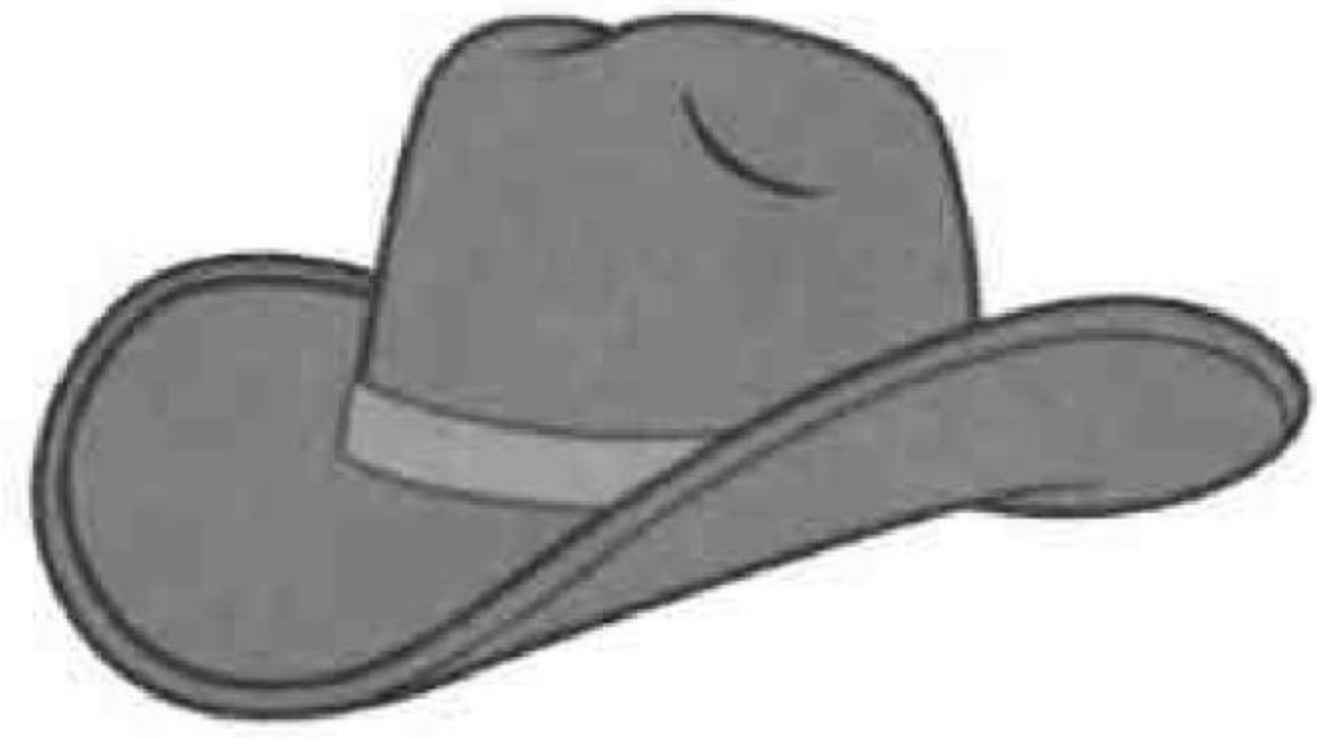
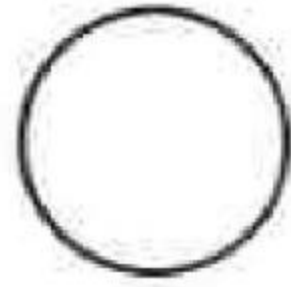

hat



boots

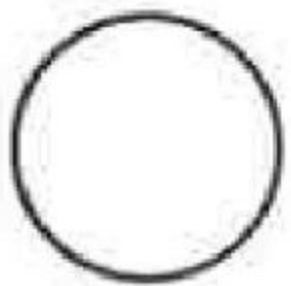

shoes

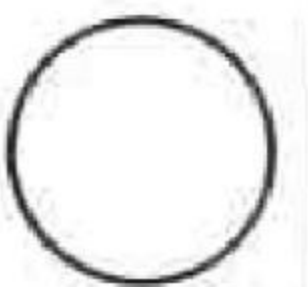

belt

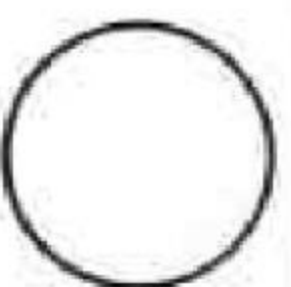

badge

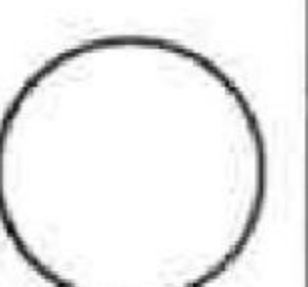

2 Draw faces. 😊 😐 😞

